

**Canon**

# EOS 6D Mark II



**INSTRUCTION  
MANUAL**

# Introduction

The EOS 6D Mark II is a digital single-lens reflex camera featuring a full-frame (approx. 35.9 x 24.0 mm) CMOS sensor with approx. 26.2 effective megapixels, DIGIC 7, normal ISO speed range of ISO 100 - ISO 40000 (for still photos), high-precision and high-speed 45-point AF (up to 45 cross-type points), maximum continuous shooting speed of approx. 6.5 shots/sec., Live View shooting, Full HD video shooting, 4K time-lapse movie shooting, Dual Pixel CMOS AF, Wi-Fi/NFC/Bluetooth (wireless communication) function, and GPS function.

## **Before Starting to Shoot, Be Sure to Read the Following**

To avoid botched pictures and accidents, first read the “Safety Precautions” (p.22-24) and “Handling Precautions” (p.25-27). Also, read this manual carefully to ensure that you use the camera correctly.

## **Refer to This Manual while Using the Camera to Further Familiarize Yourself with the Camera**

While reading this manual, take a few test shots and see how they come out. You can then better understand the camera. Be sure to store this manual safely, too, so that you can refer to it again when necessary.

## **Testing the Camera Before Use and Liability**

After shooting, play images back and check whether they have been properly recorded. If the camera or memory card is faulty and the images cannot be recorded or downloaded to a computer, Canon cannot be held liable for any loss or inconvenience caused.

## **Copyrights**

Copyright laws in your country may prohibit the use of your recorded images of people and certain subjects for anything but private enjoyment. Also be aware that certain public performances, exhibitions, etc. may prohibit photography even for private enjoyment.

## Item Check List

Before starting, check that all the following items are included with your camera. If anything is missing, contact your dealer.



**Camera**

(with eyecup and body cap)

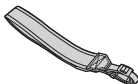

**Strap**



**Battery Pack LP-E6N**

(with protective cover)



**Battery Charger**

**LC-E6/LC-E6E\***

\* Battery Charger LC-E6 or LC-E6E is provided. (The LC-E6E comes with a power cord.)

- **The camera does not come with an interface cable or HDMI cable.**
- **The camera does not come with the Software CD-ROM.**
- The Instruction Manuals are listed on the next page.
- For Software, see page 594.
- If you purchased a Lens Kit, check that the lenses are included.
- Be careful not to lose any of the above items.
- For items sold separately, see the System Map (p.514).



When you need Lens Instruction Manuals, download them from the Canon Web site (p.4).

The Lens Instruction Manuals (PDF files) are for lenses sold individually.

Note that when purchasing the Lens Kit, some of the accessories included with the lens may not match those listed in the Lens Instruction Manual.

# Instruction Manuals



## Camera Basic Instruction Manual

### Downloading the Instruction Manuals (PDF Files)

The Instruction Manuals (PDF files) can be downloaded from the Canon Web site to your computer or the like.

- **Instruction Manual (PDF files) download site:**

- **Wi-Fi (Wireless Communication) Function Instruction Manual**
- **Lens Instruction Manual**
- **Software Instruction Manual**

▶ [www.canon.com/icpd](http://www.canon.com/icpd)



## Downloading Instruction Manuals Using QR Code

The Instruction Manuals (PDF files) can be downloaded to your smartphone or tablet using the QR code.



▶ [www.canon.com/icpd](http://www.canon.com/icpd)



- A software application is required to read out the QR code.
- Select your country or region of residence, then download the Instruction Manuals.
- Select [**Manual/software URL**] under the [**☛5**] tab to display the QR code on the camera's LCD monitor.

## Compatible Cards

The following cards can be used with the camera regardless of capacity. **If the card is new or was previously formatted (initialized) by another camera or computer, format the card with this camera (p.70).**

- **SD/SDHC\*/SDXC\* memory cards**

\* UHS-I cards supported.

### Cards that Can Record Movies

When shooting movies, use a large-capacity card with good enough performances (fast enough writing and reading speeds) to handle the movie recording quality. For details, see page 343.



In this manual, "card" refers to SD memory cards, SDHC memory cards, and SDXC memory cards.

\* **The camera does not come with a card for recording photos/movies.** Please purchase it separately.

# Quick Start Guide

1

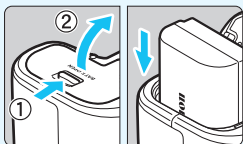

## Insert the battery (p.42).

- Upon purchase, charge the battery to start using (p.40).

2

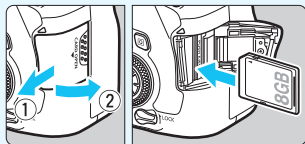

## Insert the card (p.43).

- With the card's label facing toward the back of the camera, insert it into the card slot.

3

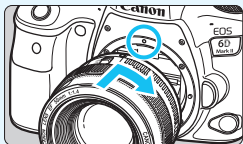

## Attach the lens (p.53).

- Align the red mount index on the lens with the red mount index on the camera to attach the lens.

4

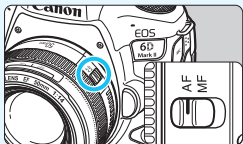

## Set the lens's focus mode switch to <AF> (p.53).

- Turn the Mode Dial while holding down the button at the center.
- All the necessary camera settings will be set automatically.

5

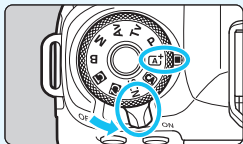

## Set the power switch to <ON>, then set the shooting mode to <A+> (p.47).

- Turn the Mode Dial while holding down the button at the center.
- All the necessary camera settings will be set automatically.

6

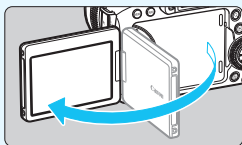
**Flip out the LCD monitor** (p.46).

- When the LCD monitor displays the date/time/zone setting screen, see page 49.

7

**Focus on the subject** (p.56).

- Look through the viewfinder and aim the viewfinder center over the subject.
- Press the shutter button halfway, and the camera will focus on the subject.

8

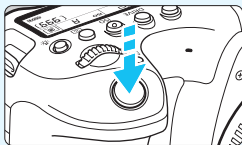
**Take the picture** (p.56).

- Press the shutter button completely to take the picture.

9





**Review the picture.**

- The image just captured will be displayed for approx. 2 sec. on the LCD monitor.
- To display the image again, press the <▶> button (p.388).



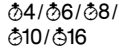

- To shoot while looking at the LCD monitor, see “Live View Shooting” (p.289).
- To view the images captured so far, see “Image Playback” (p.388).
- To delete images, see “Erasing Images” (p.430).

# Conventions Used in this Manual

## Icons in this Manual

-  : Indicates the Main Dial.
-  : Indicates the Quick Control Dial.
-  : Indicates the Multi-controller.
-  : Indicates the direction of the shift or move when the key on the Multi-controller is pressed.
-  : Indicates the Setting button.
-  : After you press an operation button, this indicates how long (in seconds) the respective setting will remain in effect after you let go of the button. The respective time will be 4 sec., 6 sec., 8 sec., 10 sec., or 16 sec.

\* In addition to the above, the icons and symbols used on the camera's buttons and displayed on the LCD monitor are also used in this manual when discussing relevant operations and functionality.

- MENU** : Indicates a function that can be changed by pressing the <MENU> button to change its settings.
- ☆ : This icon on the right of the page title indicates that the function is available only in the Creative Zone modes (<P>, <Tv>, <Av>, <M>, and <B>).
- (p.\*\*\*): Reference page numbers for more information.
-  : Warning to prevent shooting problems.
-  : Supplemental information.
-  : Tips or advice for better shooting.
-  : Troubleshooting advice.

## Notes About the Instructions and Sample Photos

- All operations described in this manual assume that the power switch is set to <ON> and the <LOCK> switch is set to the downward (Multi function lock released) (p.47, 59).
- It is assumed that all the menu settings and Custom Functions are set to their defaults.
- The illustrations in this manual show the camera attached with the EF50mm f/1.4 USM lens as an example.
- The sample photos displayed on the camera and used in this manual are for instructional purposes only.



# Chapters

	<b>Introduction</b>	2
<b>1</b>	<b>Getting Started and Basic Camera Operations</b>	39
<b>2</b>	<b>Basic Shooting</b>	93
<b>3</b>	<b>Setting the AF and Drive Modes</b>	129
<b>4</b>	<b>Image Settings</b>	161
<b>5</b>	<b>GPS Settings</b>	217
<b>6</b>	<b>Advanced Operations for Photographic Effects</b>	233
<b>7</b>	<b>Flash Photography</b>	277
<b>8</b>	<b>Shooting with the LCD Monitor (Live View Shooting)</b>	289
<b>9</b>	<b>Shooting Movies</b>	325
<b>10</b>	<b>Image Playback</b>	387
<b>11</b>	<b>Post-Processing Images</b>	437
<b>12</b>	<b>Sensor cleaning</b>	449
<b>13</b>	<b>Print Order and Photobook Set-up</b>	457
<b>14</b>	<b>Customizing the Camera</b>	467
<b>15</b>	<b>Reference</b>	513
<b>16</b>	<b>Software Start Guide / Downloading Images to a Computer</b>	593

# Contents

<b>Introduction</b>	<b>2</b>
Item Check List.....	3
Instruction Manuals .....	4
Compatible Cards.....	5
Quick Start Guide .....	6
Conventions Used in this Manual.....	8
Chapters.....	9
Index to Features .....	18
Safety Precautions .....	22
Handling Precautions .....	25
Nomenclature .....	28



## **1 Getting Started and Basic Camera Operations** **39**

Charging the Battery .....	40
Installing and Removing the Battery.....	42
Installing and Removing the Card .....	43
Using the LCD Monitor.....	46
Turning on the Power .....	47
Setting the Date, Time, and Zone.....	49
Selecting the Interface Language.....	52
Attaching and Detaching a Lens .....	53
Basic Shooting Operations.....	55
 Quick Control for Shooting Functions .....	61
 Menu Operations and Configurations.....	64
 Operating the Camera with Touch Screen .....	67



Formatting the Card .....	70
Before You Start.....	73
Disabling the Beeper .....	73
Setting the Power-off Time/Auto Power Off.....	73
Setting the Image Review Time .....	74
Turning the LCD Monitor Off/On .....	74
Reverting the Camera to the Default Settings.....	75
⌘ Displaying the Grid in the Viewfinder .....	79
📷 Displaying the Electronic Level .....	80
Setting the Viewfinder Information Display .....	82
INFO Button Functions .....	84
LOCK Setting the Multi Function Lock .....	88
Setting the Shooting Mode Guide .....	89
Setting the Feature Guide.....	90
🔍 Help.....	91

## 2 Basic Shooting **93**

📷 Fully Automatic Shooting (Scene Intelligent Auto).....	94
📷 Full Auto Techniques (Scene Intelligent Auto).....	97
📷 Creative Auto Shooting .....	100
SCN: Special Scene Mode .....	107
SCN: 📷 Shooting Portraits.....	109
SCN: 📷 Shooting Group Photos .....	110
SCN: 📷 Shooting Landscapes .....	111
SCN: 📷 Shooting Moving Subjects .....	112
SCN: 📷 Photographing Children .....	113

<b>SCN:</b>  Panning .....	114
<b>SCN:</b>  Shooting Close-ups .....	116
<b>SCN:</b>  Shooting Food .....	117
<b>SCN:</b>  Shooting Candlelight Portraits .....	118
<b>SCN:</b>  Shooting Night Portraits (With a Tripod) .....	119
<b>SCN:</b>  Shooting Night Scenes (Handheld) .....	120
<b>SCN:</b>  Shooting Backlit Scenes .....	121
 Quick Control .....	126

### **3 Setting the AF and Drive Modes 129**

AF: Selecting the AF Operation .....	130
 Selecting the AF Area and AF Point .....	134
AF Area Selection Mode .....	139
AF Sensor .....	143
Lenses and Usable AF Points .....	145
When Autofocus Fails .....	153
MF: Manual Focus .....	154
Setting Lens Electronic MF .....	155
 Selecting the Drive Mode .....	156
 Using the Self-timer .....	159

### **4 Image Settings 161**

Setting the Image-Recording Quality .....	162
Setting the Aspect Ratio .....	168
ISO: Setting the ISO Speed for Still Photos .....	170
Selecting a Picture Style .....	176









Customizing a Picture Style .....	180
Registering a Picture Style.....	183
<b>WB</b> : Setting the White Balance.....	185
<b>WB</b> White Balance Correction .....	191
Auto Correction of Brightness and Contrast .....	194
Setting Noise Reduction .....	195
Highlight Tone Priority .....	199
Correction of Lens Aberrations due to Optical Characteristics .....	200
Reducing Flicker .....	206
Setting the Color Space .....	208
Creating and Selecting a Folder .....	209
File Numbering Methods.....	211
Setting Copyright Information .....	214

## **5 GPS Settings 217**

GPS Features .....	218
GPS Precautions .....	220
Acquiring GPS Signals.....	221
Setting the Positioning Interval .....	226
Setting Time from GPS on the Camera .....	227
Logging the Route Traveled.....	228

## **6 Advanced Operations for Photographic Effects 233**



<b>P</b> : Program AE.....	234
<b>Tv</b> : Shutter-Priority AE .....	236
<b>Av</b> : Aperture-Priority AE .....	238

<b>M</b> : Manual Exposure .....	241
 Selecting the Metering Mode.....	243
 Setting the Desired Exposure Compensation .....	245
 Auto Exposure Bracketing (AEB).....	247
 Locking the Exposure for Shooting (AE Lock) .....	249
<b>B</b> : Long (Bulb) Exposures .....	250
<b>HDR</b> : HDR (High Dynamic Range) Shooting .....	253
 Multiple Exposures .....	258
 Mirror Lockup.....	265
<b>TIMER</b> Interval Timer Shooting.....	267
Using the Eyepiece Cover .....	270
Remote Control Shooting .....	271
Using a Remote Switch .....	276

## **7 Flash Photography 277**

 Flash Photography .....	278
Setting the Flash Function.....	281













## **8 Shooting with the LCD Monitor (Live View Shooting) 289**









 Shooting with the LCD Monitor .....	290
Shooting Function Settings .....	300
Menu Function Settings.....	302
Selecting the AF Operation .....	305
Focusing with AF (AF Method) .....	308
 Shooting with the Touch Shutter.....	319
MF: Focusing Manually .....	321

**9 Shooting Movies 325**

 Shooting Movies .....	326
Shooting Function Settings .....	339
Setting the Movie Recording Quality.....	341
Setting the Sound Recording .....	346
Shooting HDR Movies.....	348
 Shooting Time-lapse Movies.....	349
Shooting Video Snapshots.....	361
Menu Function Settings .....	371

**10 Image Playback 387**

 Image Playback .....	388
INFO: Shooting Information Display .....	391
 Index display (Multiple-image Display) .....	399
 Jump Display (Jumping Through Images) .....	400
 Filtering Images for Playback .....	402
 Magnifying Images .....	404
 Playing Back with the Touch Screen.....	406
 Rotating the Image .....	408
 Protecting Images .....	409
 Setting Ratings.....	412
 Quick Control for Playback.....	415
 Enjoying Movies.....	417
 Playing Back Movies.....	419
 Editing a Movie's First and Last Scenes .....	422

Slide Show (Auto Playback) .....	424
Viewing Images on a TV Set .....	427
 Erasing Images .....	430
Adjusting the LCD Monitor Brightness .....	434
Setting the Auto Rotation of Vertical Images .....	435
<b>11 Post-Processing Images</b> .....	<b>437</b>
 Processing RAW Images with the Camera .....	438
 Resizing JPEG Images .....	444
 Cropping JPEG Images .....	446
<b>12 Sensor Cleaning</b> .....	<b>449</b>
 Automatic Sensor Cleaning .....	450
Appending Dust Delete Data .....	452
Manual Sensor Cleaning .....	455
<b>13 Print order and Photobook Set-up</b> .....	<b>457</b>
 Digital Print Order Format (DPOF) .....	458
 Specifying Images for a Photobook .....	464
<b>14 Customizing the Camera</b> .....	<b>467</b>
Setting Custom Functions .....	468
Custom Functions .....	469
Custom Function Settings .....	471
 : Fine Adjustment of AF's Point of Focus .....	491
 : Custom Controls .....	497

Registering My Menu .....	505
 : Registering Custom Shooting Modes.....	510

## **15 Reference 513**

System Map .....	514
Checking the Battery Information.....	516
Using a Household Power Outlet.....	520
 Using Eye-Fi Cards .....	522
Function Availability Table by Shooting Mode .....	526
Menu Settings .....	534
Troubleshooting Guide .....	548
Error Codes.....	567
Specifications.....	568

## **16 Software Start Guide / Downloading Images to a Computer 593**

Software Start Guide.....	594
Downloading Images to a Computer.....	598
Index .....	600

# Index to Features

## Power

- Charging the battery → p.40
- Battery level → p.48
- Checking battery information → p.516
- Household power outlet → p.520
- Auto power off → p.73

## Cards

- Formatting → p.70
- Releasing shutter without card → p.44
- Cards compatible with movie recording → p.343

## Lens

- Attaching → p.53
- Detaching → p.54

## Basic Settings

- Language → p.52
- Date/Time/Zone → p.49
- Beeper → p.73
- Copyright information → p.214
- Clear all camera settings → p.75

## Viewfinder

- Dioptic adjustment → p.55
- Eyepiece cover → p.270
- Electronic level → p.81
- Grid display → p.79
- Information display in viewfinder → p.82

## LCD monitor

- Vari-angle → p.46
- Touch control → p.67
- Brightness → p.434
- Half-press Off/On → p.74
- Electronic level → p.80
- Shooting mode guide → p.89
- Feature guide → p.90
- Help → p.91

## AF

- AF operation → p.130
- AF area selection mode → p.134
- AF point selection → p.137
- Lens group → p.149
- Customizing AF functions → p.475
- Color tracking → p.142
- AF Microadjustment → p.491
- Manual focusing → p.154
- Electronic MF → p.155

## Metering

- Metering mode → p.243

## Drive

- Drive mode → p.156
- Self-timer → p.159
- Maximum burst → p.167

## Image Recording Settings

- Creating/Selecting a folder → p.209
- File numbering → p.211

## Image Quality

- Image-recording quality → p.162
- ISO speed (still photos) → p.170
- Picture Style → p.176
- White balance → p.185
- Auto Lighting Optimizer → p.194
- Noise reduction for high ISO speeds → p.195
- Noise reduction for long exposures → p.197
- Highlight tone priority → p.199
- Lens aberration correction → p.200
- Reducing flicker → p.206
- Color space → p.208

## Shooting

- Shooting mode → p.35
  - Basic Zone modes → p.35
  - SCN mode → p.108
  - Creative Zone modes → p.36
- Aspect ratio → p.168
- HDR mode → p.253
- Multiple exposures → p.258
- Mirror lockup → p.265
- Bulb timer → p.251
- Interval timer → p.267
- Depth-of-field preview → p.240
- Remote switch → p.276
- Remote control → p.271
  - Pairing → p.273
- Quick Control → p.61
- Multi function lock → p.88
- Error codes → p.567

## Exposure

- Exposure compensation → p.245
- Exposure compensation with M+ISO Auto → p.242
- AEB → p.247
- AE lock → p.249
- Safety shift → p.473

## GPS

- GPS → p.217
- Logging → p.228

**Flash**

- External flash → p.278
- Flash exposure compensation → p.278
- FE lock → p.278
- Flash function settings → p.281
- Flash Custom Function settings → p.286

**Live View Shooting**

- Live View shooting → p.289
- AF operation → p.305
- AF method → p.308
- Touch Shutter → p.319
- Magnified view → p.317
- Manual focusing → p.321
- Exposure simulation → p.303
- Silent LV shooting → p.303

**Movie Shooting**

- Autoexposure shooting → p.326
- Manual exposure shooting → p.330
- ISO speed (movie) → p.372
- AF method → p.308
- Movie Servo AF → p.373
- Movie Servo AF tracking sensitivity → p.375
- Movie Servo AF speed → p.376
- Movie recording quality → p.341
- HDR movie → p.348
- Time-lapse movie → p.349
- Video snapshot → p.361
- Sound recording → p.346
- Microphone → p.347
- Wind filter → p.346
- Attenuator → p.347
- Remote control shooting → p.381



## Playback

- Image review time → p.74
- Single-image display → p.388
- Shooting information display → p.391
- Index display → p.399
- Image browsing (Jump display) → p.400
- Setting image search conditions → p.402
- Magnified view → p.404
- Image rotation → p.408
- Protect → p.409
- Rating → p.412
- Movie playback → p.419
- Editing a movie's first and last scenes → p.422
- Slide show → p.424
- Viewing images on a TV set → p.427
- Erasing → p.430
- Touch playback → p.406
- Quick Control → p.415

## Image Editing

- RAW image processing → p.438
- Resizing JPEGs → p.444
- Cropping JPEGs → p.446

## Printing / Photobook Set-up

- Print Order (DPOF) → p.458
- Photobook Set-up → p.464

## Customization

- Custom Functions (C.Fn) → p.469
- Custom Controls → p.497
- My Menu → p.505
- Custom shooting mode → p.510

## Sensor Cleaning and Dust Reduction

- Sensor cleaning → p.450
- Append Dust Delete Data → p.452
- Manual sensor cleaning → p.455

## Software

- Software Start Guide → p.594
- Software Instruction Manuals → p.597

## Wi-Fi/NFC/Bluetooth Functions

- Wi-Fi (Wireless Communication) Function Instruction Manual

# Safety Precautions

The following precautions are provided to prevent harm or injury to yourself and others. Make sure to thoroughly understand and follow these precautions before using the product. **If you experience any malfunctions, problems, or damage to the product, contact the nearest Canon Service Center or the dealer from whom you purchased the product.**



## Warnings:

Follow the warnings below. Otherwise, death or serious injuries may result.

- To prevent fire, excessive heat, chemical leakage, explosions, and electrical shock, follow the safeguards below:
  - Do not use any batteries, power sources, or accessories not specified in the Instruction Manual. Do not use any home-made or modified batteries, or the product if it is damaged.
  - Do not insert the battery's plus and minus ends incorrectly.
  - Do not short-circuit, disassemble, or modify the battery. Do not apply heat or solder to the battery. Do not expose the battery to fire or water. Do not subject the battery to strong physical shock.
  - Do not recharge the battery in temperatures outside the allowable charging (working) temperature range. Also, do not exceed the recharge time indicated in the Instruction Manual.
  - Do not insert any foreign metallic objects into the electrical contacts of the camera, accessories, connecting cables, etc.
- When disposing of a battery, insulate the electrical contacts with tape. Contact with other metallic objects or batteries may cause a fire or an explosion.
- If excessive heat, smoke, or fumes are emitted when recharging the battery, immediately unplug the battery charger from the power outlet to stop recharging. Otherwise, it may cause a fire, heat damage, or electrical shock.
- If the battery leaks, changes color, deforms, or emits smoke or fumes, remove it immediately. Be careful not to get burned in the process. It may cause a fire, electrical shock or burns if you keep using it.
- Prevent any battery leakage from contacting your eyes, skin, and clothing. It can cause blindness or skin problems. If the battery leakage comes in contact with your eyes, skin, or clothing, flush the affected area with lots of clean water without rubbing it. See a physician immediately.
- Do not leave any cords near a heat source. It can deform the cord or melt the insulation and cause a fire or electrical shock.
- Do not hold the camera in the same position for long periods of time. Even if the camera does not feel too hot, prolonged contact with the same body part may cause skin redness or blistering due to low-temperature contact burns. Using a tripod is recommended when using the camera in very hot places or for people with circulation problems or poor skin sensation.
- Do not fire the flash at anyone driving a car or other vehicle. It may cause an accident.
- When the camera or accessories are not in use, make sure to remove the battery, and disconnect the power plug and connecting cables from the equipment before storing. This is to prevent electrical shock, excessive heat, fire, and corrosion.

- Do not use the equipment where there is flammable gas. This is to prevent an explosion or a fire.
- If you drop the equipment and the casing breaks open to expose the internal parts, do not touch the exposed internal parts. There is a possibility of an electrical shock.
- Do not disassemble or modify the equipment. High-voltage internal parts can cause electrical shock.
- Do not look at the sun or an extremely bright light source through the camera or lens. Doing so may damage your vision.
- Keep equipment out of the reach of children and infants, including when in use. Straps or cords may accidentally cause choking, electrical shock, or injury. Choking or injury may also occur if a child or infant accidentally swallows a camera part or accessory. If a child or infant swallows a part or accessory, consult a physician immediately.
- Do not use or store the equipment in dusty or humid places. Likewise, keep the battery away from metallic items and store it with its protective cover attached to prevent short-circuit. This is to prevent fire, excessive heat, electrical shock, and burns.
- Before using the camera inside an airplane or hospital, check if it is allowed. Electromagnetic waves emitted by the camera may interfere with the plane's instruments or the hospital's medical equipment.
- To prevent a fire and electrical shock, follow the safeguards below:
  - Always insert the power plug all the way in.
  - Do not handle a power plug with wet hands.
  - When unplugging a power plug, grasp and pull the plug instead of the cord.
  - Do not scratch, cut, or excessively bend the cord or put a heavy object on the cord. Also do not twist or tie the cords.
  - Do not connect too many power plugs to the same power outlet.
  - Do not use a cord whose wire is broken or insulation is damaged.
- Unplug the power plug periodically and clean off the dust around the power outlet with a dry cloth. If the surrounding is dusty, humid, or oily, the dust on the power outlet may become moist and short-circuit the outlet, causing a fire.
- Do not connect the battery directly to an electrical outlet or a car's cigarette lighter outlet. The battery may leak, generate excessive heat or explode, causing fire, burns, or injuries.
- A thorough explanation of how to use the product by an adult is required when the product is used by children. Supervise children while they are using the product. Incorrect usage may result in electrical shock or injury.
- Do not leave a lens or lens-attached camera in the sun without the lens cap attached. Otherwise, the lens may concentrate the sun's rays and cause a fire.
- Do not cover or wrap the product with a cloth when using it. Doing so may trap heat within and cause the casing to deform or catch fire.
- Be careful not to get the camera wet. If you drop the product in the water or if water or metal get inside the product, promptly remove the battery. This is to prevent fire, electrical shock, and burns.
- Do not use paint thinner, benzene, or other organic solvents to clean the product. Doing so may cause fire or a health hazard.



**Cautions:** Follow the cautions below. Otherwise, physical injury or property damage may result.

- Do not use or store the product in a high-temperature location such as inside a car under the hot sun. The product may become hot and cause burns. Doing so may also cause battery leakage or explosion, which will degrade the performance or shorten the life of the product.
- Do not carry the camera around when it is attached to a tripod. Doing so may cause an injury or an accident. Also make sure the tripod is sturdy enough to support the camera and lens.
- Do not leave the product in a low-temperature environment for an extended period of time. The product will become cold and may cause injury when touched.
- Do not fire the flash near the eyes. It may hurt the eyes.
- If any abnormal skin reaction or irritation occurs during or following the use of this product, refrain from further use and get medical advice/attention.

# Handling Precautions

## Camera Care

- This camera is a precision instrument. Do not drop it or subject it to physical shock.
- The camera is not waterproof and cannot be used underwater.
- To maximize the camera's dust- and drip- resistance, keep the terminal cover, battery compartment cover, card slot cover, and all other covers firmly closed.
- This camera is designed to be dust- and drip- resistant, in order to help prevent sand, dust, dirt, or water that falls on it unexpectedly from getting inside, but it is impossible to prevent dirt, dust, water, or salt from getting inside at all. As far as possible, do not allow dirt, dust, water, or salt to get on the camera.
- If water gets on the camera, wipe it off with a dry and clean cloth. If dirt, dust, or salt gets on the camera, wipe it off with a clean, well-wrung wet cloth.
- Using the camera in a location with large amounts of dirt or dust may cause a malfunction.
- Cleaning the camera after use is recommended. Allowing dirt, dust, water, or salt to remain on the camera may cause a malfunction.
- If you accidentally drop the camera into water or are concerned that moisture (water), dirt, dust, or salt may have gotten inside it, promptly consult the nearest Canon Service Center.
- Never leave the camera near anything having a strong magnetic field such as a magnet or electric motor. Also, avoid using or leaving the camera near anything emitting strong radio waves, such as a large antenna. Strong magnetic fields can cause camera misoperation or destroy image data.
- Do not leave the camera in excessive heat, such as in a car in direct sunlight. High temperatures can cause the camera to malfunction.
- The camera contains precision electronic circuitry. Never attempt to disassemble the camera yourself.

- Do not block the mirror operation with your finger, etc. Doing so may cause a malfunction.
- Use only a commercially-available blower to blow away dust when it adheres to the lens, viewfinder, reflex mirror, focusing screen, etc. Do not use cleaners that contain organic solvents to clean the camera body or lens. For stubborn dirt, take the camera to the nearest Canon Service Center.
- Do not touch the camera's electrical contacts with your fingers. This is to prevent the contacts from corroding. Corroded contacts can cause camera malfunction.
- If the camera is suddenly brought in from the cold into a warm room, condensation may form on the camera and internal parts. To prevent condensation, first put the camera in a sealed plastic bag and let it adjust to the warmer temperature before taking it out of the bag.
- If condensation forms on the camera, do not use the camera. This is to avoid damaging the camera. If there is condensation, remove the lens, card and battery from the camera, and wait until condensation has evaporated before using the camera.
- If the camera will not be used for an extended period, remove the battery and store the camera in a cool, dry, well-ventilated location. Even while the camera is in storage, press the shutter button a few times once in a while to check that the camera is still working.
- Avoid storing the camera where there are chemicals that result in rust and corrosion such as in a chemical lab.
- If the camera has not been used for an extended period, test all its functions before using it. If you have not used the camera for some time or if there is an important shoot such as a foreign trip coming up, have the camera checked by your nearest Canon Service Center or check the camera yourself and make sure it is working properly.
- If you repeat continuous shooting or perform Live View shooting or movie shooting for a prolonged period, the camera may become hot. This is not a malfunction.
- If there is a bright light source inside or outside the image area, ghosting may occur.

## LCD Panel and LCD Monitor

- Although the LCD monitor is manufactured with very high precision technology with over 99.99% effective pixels, 0.01% or fewer of the pixels may be dead, and there may also be spots of black, red, or other colors. This is not a malfunction. They do not affect the images recorded.
- If the LCD monitor is left on for a prolonged period, screen burn-in may occur where you see remnants of what was displayed. However, this is only temporary and will disappear when the camera is left unused for a few days.
- The LCD monitor display may seem slightly slow in low temperatures or may look black in high temperatures. It will return to normal at room temperature.

## Cards

To protect the card and its recorded data, note the following:

- Do not drop, bend, or wet the card. Do not subject it to excessive force, physical shock, or vibration.
- Do not touch the card's electronic contacts with your fingers or anything metallic.
- Do not affix any stickers, etc. on the card.
- Do not store or use the card near anything that has a strong magnetic field, such as a TV set, speakers, or magnets. Also avoid places prone to having static electricity.
- Do not leave the card in direct sunlight or near a heat source.
- Store the card in a case.
- Do not store the card in hot, dusty, or humid locations.

## Lens

After detaching the lens from the camera, put down the lens with the rear end up and attach the rear lens cap to avoid scratching the lens surface and electrical contacts.

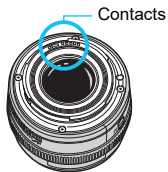

# Nomenclature

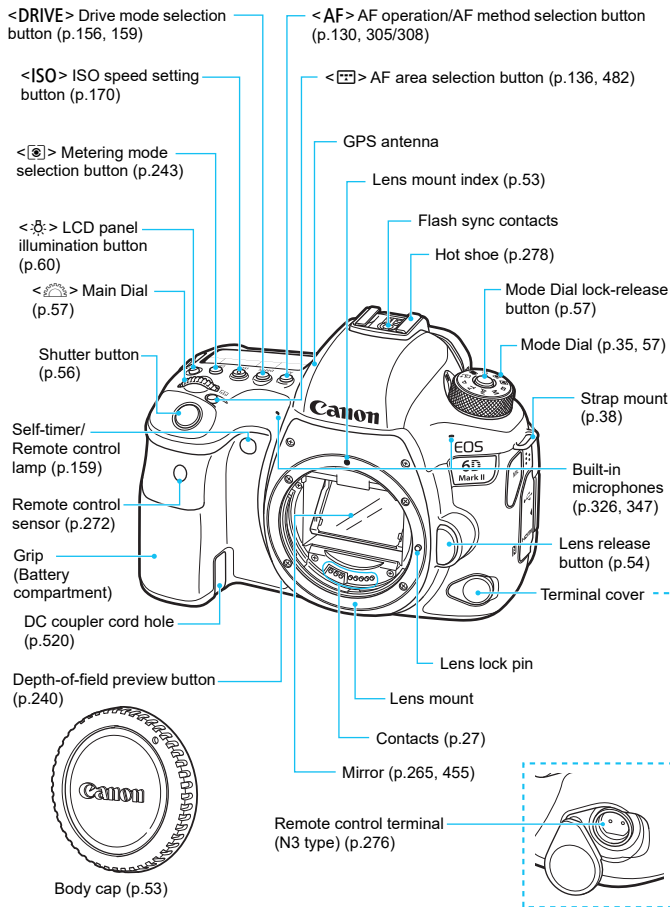



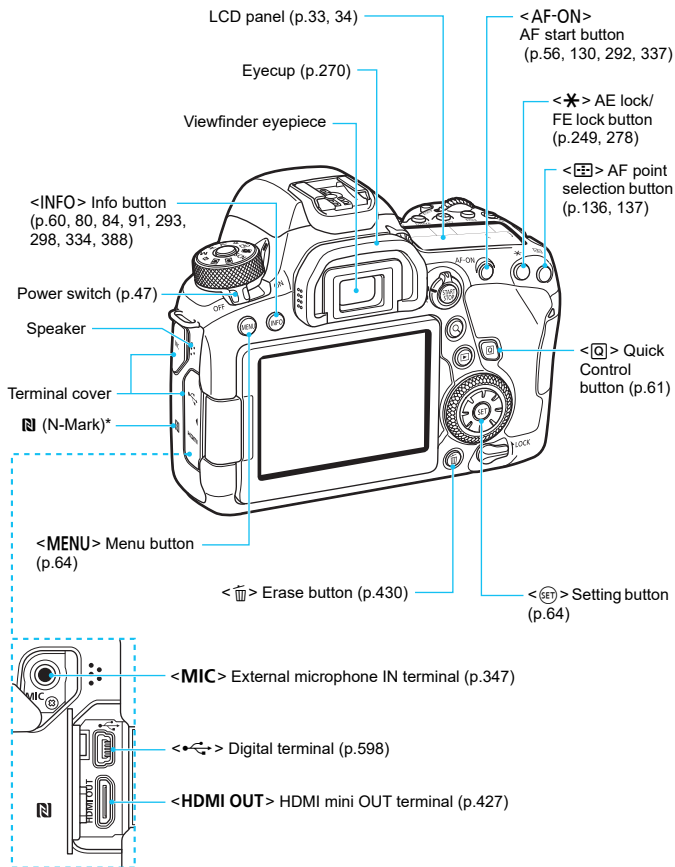

\* Used for Wi-Fi connections via the NFC function.

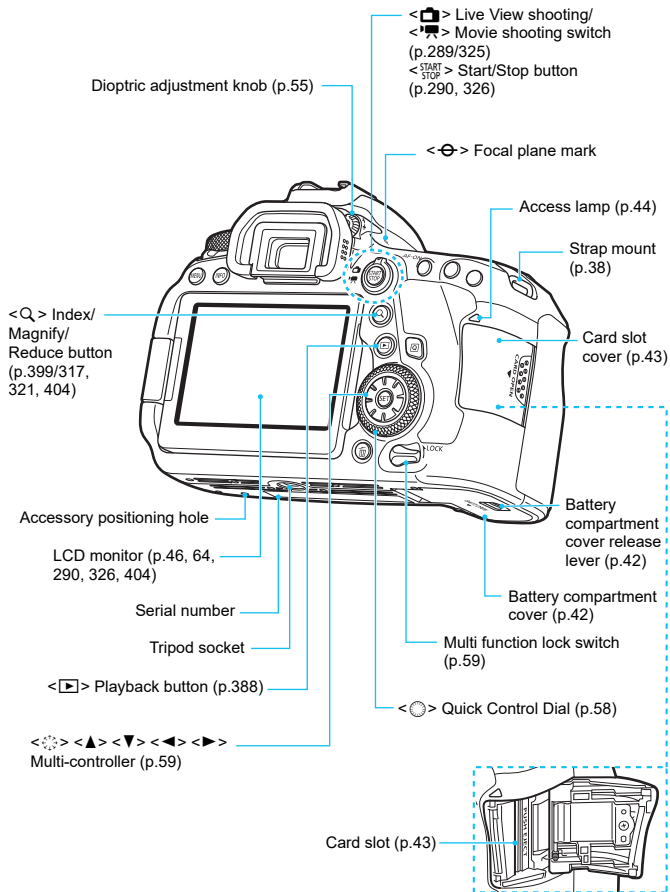

## Viewfinder Information Display

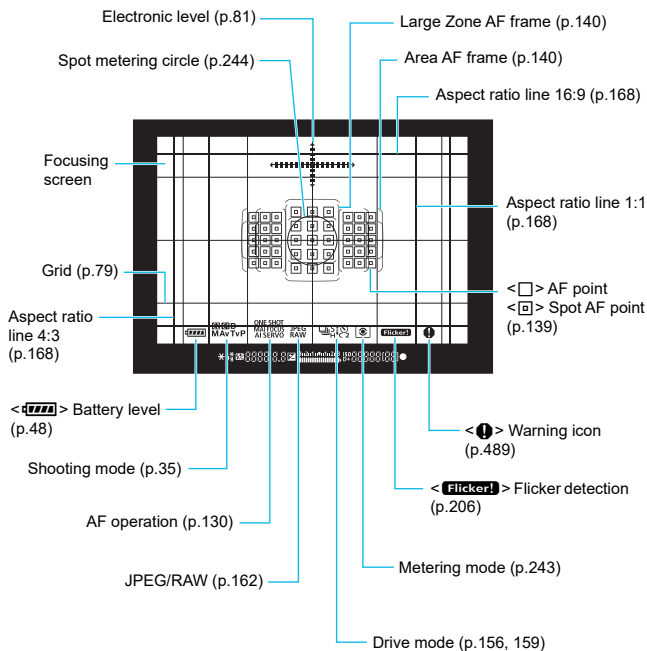

\* The display will show only the settings currently applied.

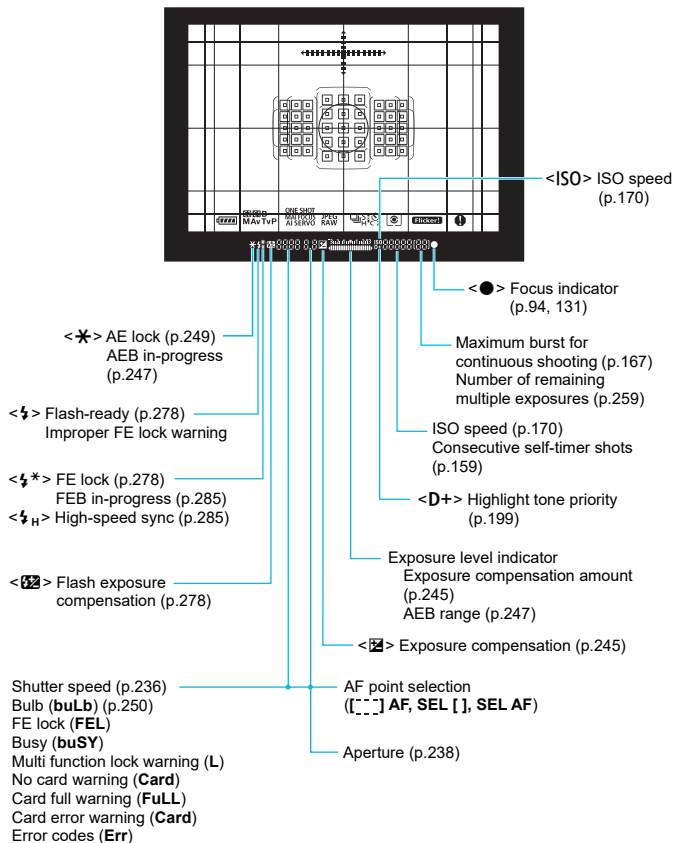

## LCD Panel

Drive mode (p.156, 159)

- Single shooting
- H High-speed continuous shooting
- Low-speed continuous shooting
- S Silent single shooting
- S Silent continuous shooting
- Self-timer: 10 sec./remote control
- 2 Self-timer: 2 sec./remote control
- c Self-timer: Continuous

AF operation (p.130, 305)

- ONE SHOT**  
One-Shot AF
- AI FOCUS**  
AI Focus AF
- AI SERVO**  
AI Servo AF
- SERVO**  
Servo AF
- M FOCUS**  
Manual focus  
(p.154, 321)

AF point selection  
([] AF, SEL [], SEL AF)

- Shutter speed
- Bulb (**buLb**)
- FE lock (**FEL**)
- Remaining number of shots for time-lapse movie
- Busy (**buSY**)
- Multi function lock warning (**L**)
- Cleaning image sensor (**CLn**)
- No card warning (**Card**)
- Card full warning (**FuLL**)
- Card error warning (**Card**)
- Error codes (**Err**)

&lt;D+&gt; Highlight tone priority (p.199)

&lt;ISO&gt; ISO speed (p.170)

ISO speed (p.170)  
Consecutive self-timer shots  
(p.159)

Metering mode (p.243)

- Evaluative metering
- Partial metering
- Spot metering
- Center-weighted average metering

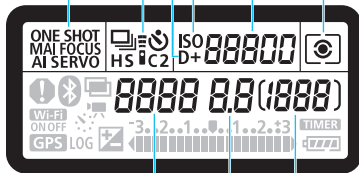

- Possible shots
- Self-timer countdown
- Bulb exposure time
- Error number
- Remaining images to record

Aperture

\* The display will show only the settings currently applied.

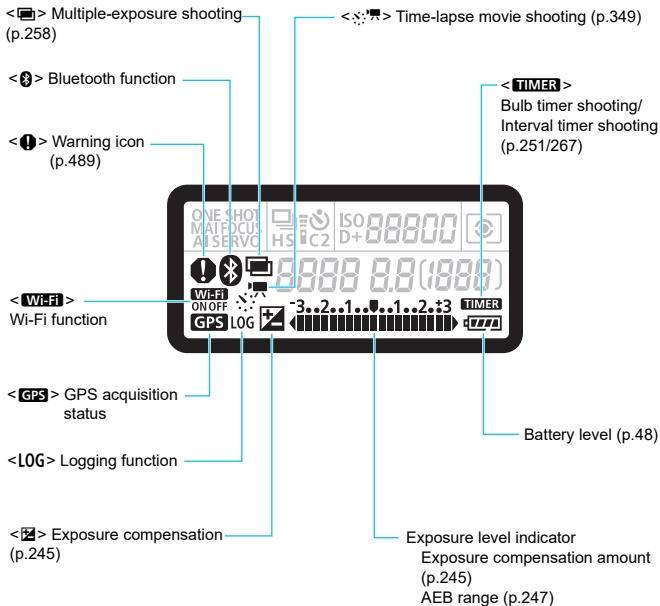

## Mode Dial

You can set the shooting mode. Turn the Mode Dial while holding down the Mode Dial center (Mode Dial lock release button).

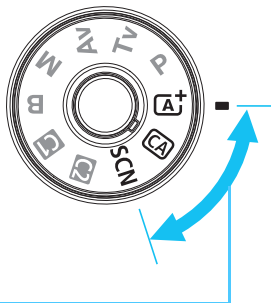













## Basic Zone

All you do is press the shutter button. The camera sets everything to suit the subject or scene for shooting.

**A+** : **Scene Intelligent Auto** (p.94)

**CA** : **Creative Auto** (p.100)

**SCN** : **Special scene** (p.107)

	<b>Portrait</b> (p.109)		<b>Close-up</b> (p.116)
	<b>Group Photo</b> (p.110)		<b>Food</b> (p.117)
	<b>Landscape</b> (p.111)		<b>Candlelight</b> (p.118)
	<b>Sports</b> (p.112)		<b>Night Portrait</b> (p.119)
	<b>Kids</b> (p.113)		<b>Handheld Night Scene</b> (p.120)
	<b>Panning</b> (p.114)		<b>HDR Backlight Control</b> (p.121)

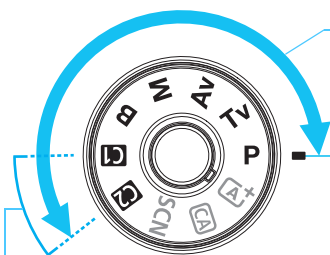

### Creative Zone

These modes give you more control for shooting various subjects as desired.

- P** : Program AE (p.234)
- Tv** : Shutter-priority AE (p.236)
- Av** : Aperture-priority AE (p.238)
- M** : Manual exposure (p.241)
- B** : Bulb (p.250)

### Custom shooting mode

You can register the shooting mode (<**P**>, <**Tv**>, <**Av**>, <**M**>, or <**B**>), AF operation, menu settings, etc. to the <**C1**> and <**C2**> Mode Dial positions (p.510).



**Battery Charger LC-E6**

Charger for Battery Pack LP-E6N/LP-E6 (p.40).

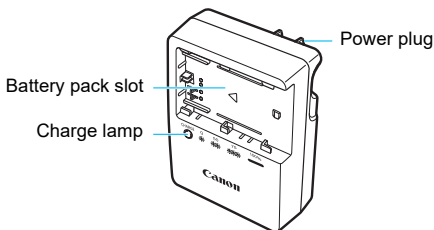

**IMPORTANT SAFETY INSTRUCTIONS-SAVE THESE INSTRUCTIONS.  
DANGER-TO REDUCE THE RISK OF FIRE OR ELECTRIC SHOCK,  
CAREFULLY FOLLOW THESE INSTRUCTIONS.**

For connection to a supply not in the U.S.A., use an attachment plug adapter of the proper configuration for the power outlet, if needed.

**Battery Charger LC-E6E**

Charger for Battery Pack LP-E6N/LP-E6 (p.40).

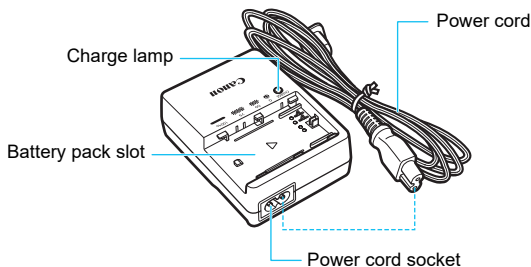

## Attaching the Strap

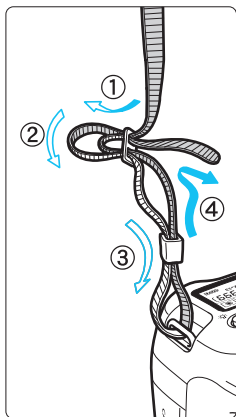

Pass the end of the strap through the camera's strap mount eyelet from the bottom. Then pass it through the strap's buckle as shown in the illustration. Pull the strap to take up any slack and make sure the strap will not loosen from the buckle.

- The strap also has an attached eyepiece cover (p.270).

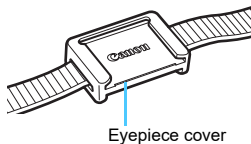

# 1

## Getting Started and Basic Camera Operations

This chapter describes preparatory steps before you start shooting and the basic camera operations.

# Charging the Battery

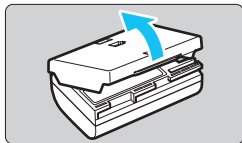

## 1 Remove the protective cover.

- Detach the protective cover provided with the battery.

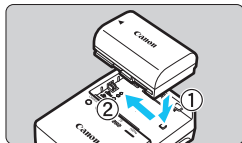

## 2 Attach the battery.

- As shown in the illustration, attach the battery securely to the charger.
- To detach the battery, follow the above procedure in reverse.

### LC-E6

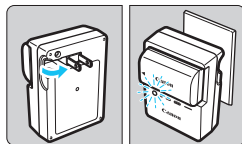

## 3 Recharge the battery.

### For LC-E6

- As shown by the arrow, flip out the battery charger's prongs and insert the prongs into a power outlet.

### LC-E6E

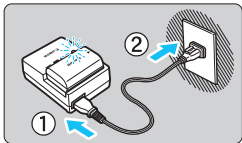

### For LC-E6E

- Connect the power cord to the charger and insert the plug into a power outlet.
- ▶ Recharging starts automatically and the charge lamp blinks in orange.

Charge Level	Charge Lamp	
	Color	Display
0-49%	Orange	Blinks once per second
50-74%		Blinks twice per second
75% or higher		Blinks three times per second
Fully charged	Green	Turned on

- It takes approx. 2 hr. and 30 min. to fully recharge a completely exhausted battery at room temperature (23°C / 73°F). The time required to recharge the battery will vary greatly depending on the ambient temperature and the battery's remaining capacity.
- For safety reasons, recharging in low temperatures (5°C - 10°C / 41°F - 50°F) will take longer (up to approx. 4 hr.).



## Tips for Using the Battery and Charger

- **Upon purchase, the battery is not fully charged.**  
Charge the battery before use.
- **Recharge the battery on the day before or on the day it is to be used.**  
Even during storage, a charged battery will gradually drain and lose its capacity.
- **After recharging the battery, detach it and disconnect the charger from the power outlet.**

- **You can attach the cover in a different orientation to indicate whether the battery is recharged or not.**



If the battery is recharged, attach the cover so that the battery-shaped hole <img alt="battery-shaped hole icon" data-bbox="315 405 345 425"/> is aligned over the blue sticker on the battery. If the battery is exhausted, attach the cover in the opposite orientation.

- **When not using the camera, remove the battery.**  
If the battery is left in the camera for a prolonged period, a small amount of power current will continue to be released, resulting in excess discharge and shorter battery life. Store the battery with the protective cover attached. Storing the battery when it is fully charged may lower the battery performance.
- **The battery charger can also be used in foreign countries.**  
The battery charger is compatible with a 100 V AC to 240 V AC 50/60 Hz power source. If necessary, attach a commercially-available plug adapter for the respective country or region. Do not attach any portable voltage transformer to the battery charger. Doing so may damage the battery charger.
- **If the battery becomes exhausted quickly even after having been fully charged, the battery has reached the end of its service life.**  
Check the battery's recharge performance (p.516) and purchase a new battery.



- After disconnecting the charger's power plug, do not touch the prongs for approx. 10 sec.
- If the battery's remaining capacity (p.516) is 94% or higher, the battery will not be recharged.
- The provided charger cannot charge any battery other than Battery Pack LP-E6N/LP-E6.

# Installing and Removing the Battery

Load a fully-charged Battery Pack LP-E6N (or LP-E6) into the camera. The camera's viewfinder becomes bright when a battery is installed, and darkens when the battery is removed. If the battery is not installed, the image in the viewfinder becomes blurred and you cannot perform focusing.

## Installing the Battery

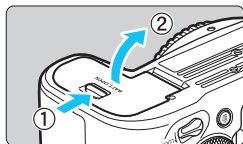

### 1 Open the cover.

- Slide the lever as shown by the arrows and open the cover.

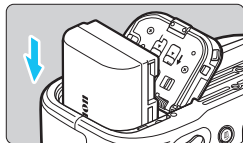

### 2 Insert the battery.

- Insert the end with the electrical contacts.
- Insert the battery until it locks in place.

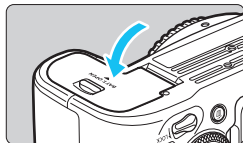

### 3 Close the cover.

- Press the cover until it snaps shut.

 You cannot use batteries other than the Battery Pack LP-E6N or LP-E6.

## Removing the Battery

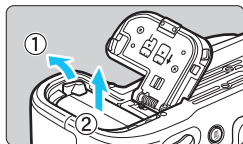

### Open the cover and remove the battery.

- Press the battery lock lever as shown by the arrow and remove the battery.
- To prevent short circuiting, be sure to attach the provided protective cover (p.40) to the battery.

# Installing and Removing the Card

You can use an SD, SDHC, or SDXC memory card (sold separately) with the camera. The captured images are recorded onto the card.

- **Make sure the card's write-protect switch is set upward to enable writing and erasing.**

## Installing the Card

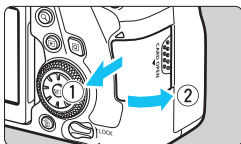

### 1 Open the cover.

- Slide the cover as shown by the arrows to open it.

Write-protect switch

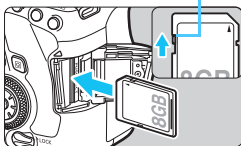

### 2 Insert the card.

- As shown by the illustration, face the card's label side toward you and insert it until it clicks in place.

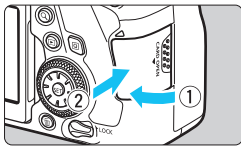

### 3 Close the cover.

- Close the cover and slide it in the direction shown by the arrows until it snaps shut.
- When you set the power switch to <ON>, the number of possible shots will be displayed on the LCD panel.



Possible shots

## Removing the Card

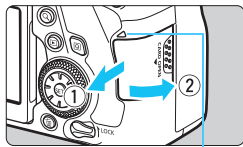

Access lamp

### 1 Open the cover.

- Set the power switch to <OFF>.
- Check that the access lamp is off, then open the cover.
- If [Recording...] is displayed on the LCD monitor, close the cover.

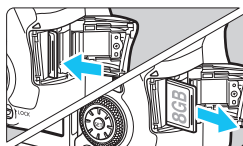

### 2 Remove the card.

- Gently push in the card, then let it go to eject.
- Pull the card straight out, then close the cover.

- 
- UHS-I SDHC or SDXC memory cards can also be used.
  - The number of possible shots varies depending on the remaining capacity of the card, the settings of image-recording quality, ISO speed, etc.
  - Setting [📷1: Release shutter without card] to [Disable] will prevent you from forgetting to insert a card (p.535).





- **When the access lamp is lit or blinking, it indicates that images are being written to, read from, or erased from the card, or data is being transferred. Do not open the card slot cover during this time. Also, never do any of the following while the access lamp is lit or blinking. Otherwise, it can damage the image data, card, or camera.**
  - **Removing the card.**
  - **Removing the battery.**
  - **Shaking or banging the camera around.**
  - **Unplugging and connecting a power cord** (when household power outlet accessories (sold separately, p.520) are used).
- If the card already contains recorded images, the image number may not start from 0001 (p.211).
- If a card-related error message is displayed on the LCD monitor, remove and reinsert the card. If the error persists, use a different card. If you can transfer images on the card to a computer, transfer all the images and then format the card with the camera (p.70). The card may then return to normal.
- Do not touch the card's contacts with your fingers or metal objects. Do not expose the contacts to dust or water. If smudges adhere to the contacts, contact failure may result.
- Multimedia cards (MMC) cannot be used. (Card error will be displayed.)

## Using the LCD Monitor

After you flip out the LCD monitor, you can set menu functions, use Live View shooting, shoot movies, or play back photos and movies. You can change the direction and angle of the LCD monitor.

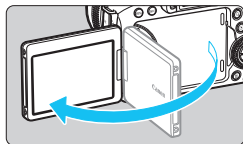

### 1 Flip out the LCD monitor.

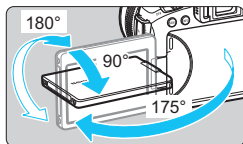

### 2 Rotate the LCD monitor.

- When the LCD monitor is swung out, you can rotate it up, down, or over 180° to face the subject.
- The indicated angle is only approximate.

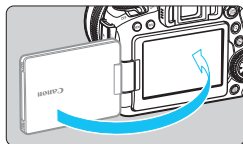

### 3 Face it toward you.

- Normally, use the camera with the LCD monitor facing you.

- Be careful not to exert excessive force and break the hinge when rotating the LCD monitor.
- When a cable is connected to a camera terminal, the rotation angle range of the flipped out LCD monitor will be limited.

- When not using the camera, close the LCD monitor with the screen facing inward. You can protect the screen.
- During Live View shooting or movie shooting, facing the LCD monitor toward the subject will display a mirror image on the screen (right/left reversed).

## Turning on the Power

If you turn on the power switch and the date/time/zone setting screen appears, see page 49 to set the date/time/zone.

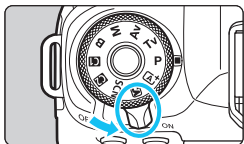

<ON> : The camera turns on.

<OFF> : The camera is turned off and does not function. Set the power switch to this position when not using the camera.

## Automatic Sensor Cleaning

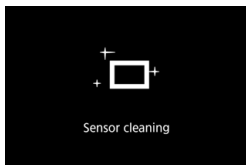

- Whenever you set the power switch to <ON> or <OFF>, sensor cleaning will be performed automatically. (A small sound may be heard.) During the sensor cleaning, the LCD monitor will display <[Sensor Cleaning Icon]>.

- Even during the sensor cleaning, if you press the shutter button halfway (p.56), cleaning operation will be stopped, and you can take a picture immediately.
- If you repeatedly turn the power switch <ON>/<OFF> at a short interval, the <[Sensor Cleaning Icon]> icon may not be displayed. This is normal and not a malfunction.

## **MENU** Auto Power Off

- To save battery power, the camera turns off automatically after approx. 1 minute of non-operation. To turn on the camera again, just press the shutter button halfway (p.56).
- You can change the auto power off time with [**F2: Auto power off**] (p.73).







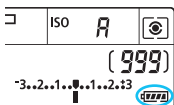

If you set the power switch to <OFF> while an image is being recorded to the card, [**Recording...**] will be displayed and the power will turn off after the recording finishes.

## Battery Level Indicator

When the power switch is set to <ON>, the battery level will be indicated in one of six levels. A blinking battery icon < > indicates that the battery will soon be exhausted.



Display			
Level (%)	100 - 70	69 - 50	49 - 20

Display			
Level (%)	19 - 10	9 - 1	0



## Number of Possible Shots with Viewfinder Shooting

(Approx. number of shots)

Temperature	Room Temperature (23°C / 73°F)	Low Temperatures (0°C / 32°F)
Possible shots	1200	1100

- The figures above are based on a fully-charged Battery Pack LP-E6N, no Live View shooting, and CIPA (Camera & Imaging Products Association) testing standards.
- With Battery Grip BG-E21 (sold separately) loaded with two LP-E6N battery packs, the number of possible shots will be approximately doubled.

-  Doing any of the following will exhaust the battery faster:
  - Pressing the shutter button halfway for a prolonged period.
  - Activating the AF frequently without taking a picture.
  - Using the lens's Image Stabilizer.
  - Using the LCD monitor frequently.
  - Using the GPS function, Wi-Fi function, or Bluetooth function.
- The number of possible shots may decrease depending on the actual shooting conditions.
- The lens operation is powered by the camera's battery. Certain lenses may exhaust the battery faster than others.
- In low ambient temperatures, shooting may not be possible even with a sufficient battery level.

-  For the number of possible shots with Live View shooting, see page 291.
- See [ 4: Battery info.] to check the battery status (p.516).

## MENU Setting the Date, Time, and Zone

When you turn on the power for the first time or if the date/time/zone have been reset, the date/time/zone setting screen will appear. Follow the steps below to set the time zone first.

Set the camera to the time zone in which you currently live so that when you travel, you can simply change the setting to the correct time zone for your destination, and the camera will automatically adjust the date/time.

**Note that the date/time appended to recorded images will be based on this date/time setting. Be sure to set the correct date/time.**

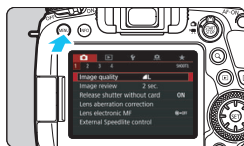

### 1 Display the menu screen.

- Press the <MENU> button to display the menu screen.

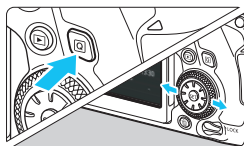

### 2 Under the [Q] tab, select [Date/Time/Zone].

- Press the <Q> button and select the [Q] tab.
- Press the <◀> <▶> keys to select the [Q] tab.
- Press the <▲> <▼> keys to select [Date/Time/Zone], then press <SET>.

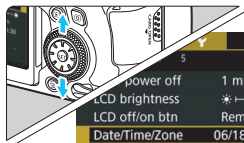

### 3 Set the time zone.

- [London] is set by default.
- Press the <◀> <▶> keys to select [Time zone], then press <SET>.



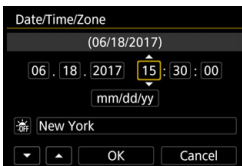
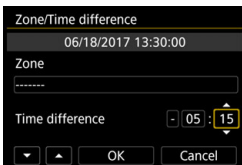
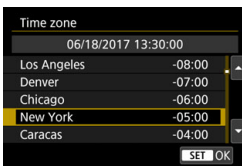
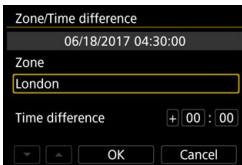

- Press the <◀> <▶> keys to select [Zone], then press <SET>.
- Press the <▲> <▼> keys to select the time zone, then press <SET>.
- If your desired time zone is not listed, press the <MENU> button, then proceed to the next step to set it (with the time difference from the Coordinated Universal Time, UTC).
- To set the time difference from UTC, press the <◀> <▶> keys to select a parameter (+/-/hour/minute) for [Time difference].
- Press <SET> so <☐> is displayed.
- Press the <▲> <▼> keys to set it, then press <SET>. (Returns to <☐>.)
- After entering the time zone or time difference, press the <◀> <▶> keys to select [OK], then press <SET>.

## 4 Set the date and time.

- Press the <◀> <▶> keys to select the number.
- Press <SET> so <☐> is displayed.
- Press the <▲> <▼> keys to set it, then press <SET>. (Returns to <☐>.)

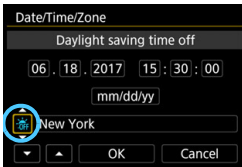

## 5 Set the daylight saving time.

- Set it as necessary.
- Press the <◀> <▶> keys to select [☀️].
- Press <SET> so <☀️> is displayed.
- Press the <▲> <▼> keys to select [☀️], then press <SET>.
- When the daylight saving time is set to [☀️], the time set in step 4 will advance by 1 hr. If [☀️] is set, the daylight saving time will be canceled and the time will go back by 1 hour.

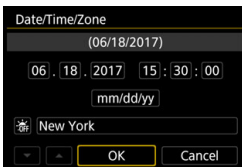

## 6 Exit the setting.

- Press the <◀> <▶> keys to select [OK], then press <SET>.
- ▶ The date, time, time zone, and daylight saving time will be set.



- The date/time/zone settings may be reset when the camera is stored without the battery, when its battery becomes exhausted, or when it is exposed to below freezing temperatures for a prolonged period. If this happens, set the date/time/zone again.
- After changing [Zone/Time difference], check that the correct date/time are set.



- The date/time that were set will start from when you select [OK] in step 6.
- In step 3, the time displayed in [Time zone] is the time difference compared with Coordinated Universal Time (UTC).
- Even if [⚡2: Auto power off] is set to [1 min.], [2 min.], or [4 min.], the auto power off time will be approx. 6 min. when the [⚡2: Date/Time/Zone] screen is displayed.
- Automatic time update is possible with GPS function (p.227).

## MENU Selecting the Interface Language

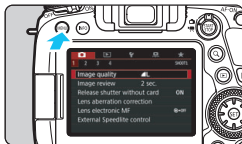

### 1 Display the menu screen.

- Press the <MENU> button to display the menu screen.

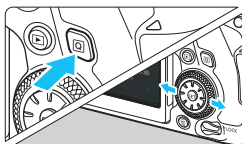

### 2 Under the [F2] tab, select [Language].

- Press the <Q> button and select the [F2] tab.
- Press the <◀> <▶> keys to select the [F2] tab.
- Press the <▲> <▼> keys to select [Language], then press <SET>.

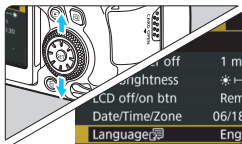

### 3 Set the desired language.

- Press the <▲> <▼> keys to select the language, then press <SET>.
- ▶ The interface language will change.





# Attaching and Detaching a Lens

The camera is compatible with all Canon EF lenses. **The camera cannot be used with EF-S or EF-M lenses.**

## Attaching a Lens

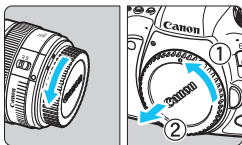

### 1 Remove the caps.

- Remove the rear lens cap and the body cap by turning them as shown by the arrows.

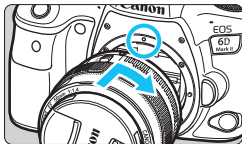

### 2 Attach the lens.

- Align the red mount index on the lens with the red mount index on the camera and turn the lens as shown by the arrow until it clicks in place.

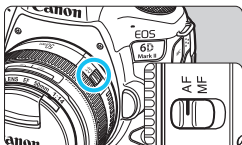

### 3 Set the lens's focus mode switch to <AF>.

- <AF> stands for autofocus.
- <MF> stands for manual focus. Autofocus will not operate.

### 4 Remove the front lens cap.

## Detaching the Lens

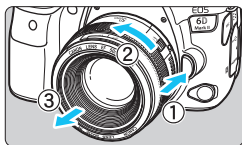

**While pressing the lens release button, turn the lens as shown by the arrow.**

- Turn the lens until it stops, then detach it.
- Attach the rear lens cap to the detached lens.

- ⚠ Do not look at the sun directly through any lens. Doing so may cause loss of vision.
- When attaching or detaching a lens, set the camera's power switch to <OFF>.
- If the front part (focusing ring) of the lens rotates during autofocus, do not touch the rotating part.

 For instructions on how to use the lens, refer to the Lens Instruction Manual (p.4).

### Tips for Avoiding Smudges and Dust

- When changing lenses, do it quickly in a place with minimal dust.
- When storing the camera without a lens attached, be sure to attach the body cap to the camera.
- Remove dust on the body cap before attaching it.

# Basic Shooting Operations

## Adjusting the Viewfinder Clarity

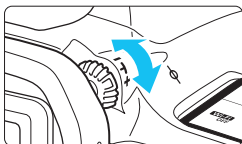

### Turn the dioptic adjustment knob.

- Turn the knob left or right so that the AF points in the viewfinder look sharp.
- If the knob is difficult to turn, remove the eyecup (p.270).



If the camera's dioptic adjustment still cannot provide a sharp viewfinder image, using E-series Dioptic Adjustment Lenses (sold separately) is recommended.

## Holding the Camera

To obtain sharp images, hold the camera still to minimize camera shake.

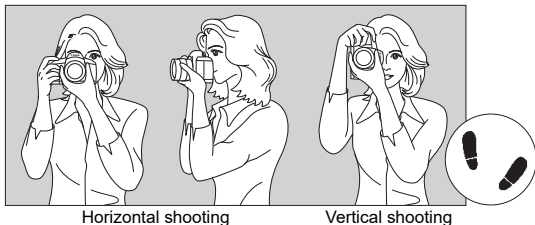

Horizontal shooting

Vertical shooting

1. Wrap your right hand around the camera grip firmly.
2. Hold the lens bottom with your left hand.
3. Rest your right index finger lightly on the shutter button.
4. Press your arms and elbows lightly against the front of your body.
5. To maintain a stable stance, place one foot slightly ahead of the other.
6. Press the camera against your face and look through the viewfinder.



To shoot while looking at the LCD monitor, see page 289.

## Shutter Button

The shutter button has two steps. You can press the shutter button halfway. Then you can further press the shutter button completely.

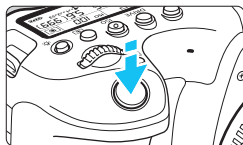

### Pressing Halfway

This activates autofocus and the automatic exposure system that sets the shutter speed and aperture.

The exposure setting (shutter speed and aperture) is displayed in the viewfinder and on the LCD panel for approx. 4 sec. (metering timer/ $\odot$ 4).



### Pressing Completely

This releases the shutter and takes the picture.

### ● Preventing Camera Shake

Hand-held camera movement during the moment of exposure is called camera shake. It can cause blurred pictures. To prevent camera shake, note the following:

- Hold and steady the camera as shown on the preceding page.
- Press the shutter button halfway to autofocus, then slowly press the shutter button completely.



- In Creative Zone modes, pressing the <AF-ON> button is the same as pressing the shutter button halfway.
- If you press the shutter button completely without pressing it halfway first, or if you press the shutter button halfway and then press it completely immediately, the camera will take a moment before it takes the picture.
- Even during menu display or image playback, you can go back to shooting-ready state by pressing the shutter button halfway.

## Mode Dial

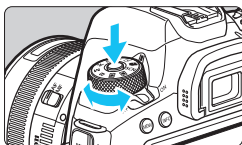

**Turn the dial while holding down the lock release button at the center of the dial.**

Use it to set the shooting mode.



## Main Dial

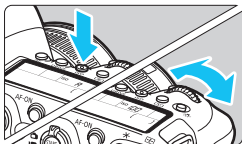

- (1) **After pressing a button, turn the <Main Dial> dial.**

When you press a button such as <AF>, <DRIVE>, <ISO>, or <METERING>, the respective function remains selectable for approx. 6 sec. (6). During this time, you can turn the <Main Dial> dial to change the setting.

When the timer ends or if you press the shutter button halfway, the camera will go back to shooting-ready state.

- Use this dial to select the AF operation, drive mode, ISO speed, metering mode, AF point, etc.

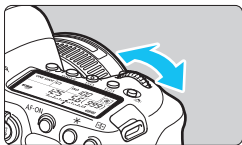

- (2) **Turn only the <Main Dial> dial.**

While looking at the viewfinder display or LCD panel, turn the <Main Dial> dial.

- Use this dial to set the shutter speed, aperture, etc.



The operations in (1) can be performed even when the <LOCK> switch is set upward (Multi function lock, p.59).

## Quick Control Dial

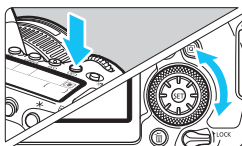

### (1) After pressing a button, turn the <QCD> dial.

When you press a button such as <AF>, <ISO>, or <METERING>, the respective function remains selectable for approx. 6 sec.

(6). During this time, you can turn the <QCD> dial to change the setting.

When the timer ends or if you press the shutter button halfway, the camera will go back to shooting-ready state.

- Use this dial to select the AF operation, ISO speed, metering mode, AF point, etc.

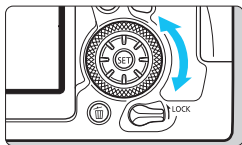

### (2) Turn only the <QCD> dial.

While looking at the viewfinder or LCD panel, turn the <QCD> dial.

- Use this dial to set the exposure compensation amount, the aperture setting for manual exposures, etc.

 The operations in (1) can be performed even when the <LOCK> switch is set upward (Multi function lock, p.59).

## Multi-controller

The  consists of an eight-direction key.

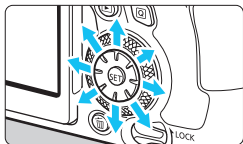

- Use it to select the AF point, correct the white balance, move the AF point or magnifying frame during Live View shooting or movie shooting, set the Quick Control, etc.
- You can also use it to select menu items.

 Correcting the white balance and moving the magnifying frame during playback can be done even with the <LOCK> switch set upward (Multi Function Lock).

## LOCK Multi Function Lock

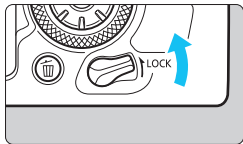

With [**4: Multi function lock**] set and the <LOCK> switch set upward, you can prevent the settings from being changed by accidentally operating Main Dial, Quick Control Dial, or Multi-controller or by inadvertently tapping on the touch screen.

For [**4: Multi function lock**] details, see page 88.







<LOCK> switch set upward: Lock engaged

<LOCK> switch set downward: Lock released

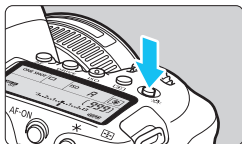
 By default, the  dial will be locked when the multi function lock switch is in the lock position.

## LCD Panel Illumination



You can illuminate the LCD panel by pressing the  button. Turn on () or off the LCD panel illumination by pressing the  button.

 During a bulb exposure, pressing the shutter button completely will turn off the LCD panel illumination.

## Displaying the Quick Control Screen

After you press the <INFO> button a number of times (p.84), the Quick Control screen (p.86) will appear. You can then check the current shooting function settings.

Pressing the <Q> button enables Quick Control of the shooting function settings (p.61).

Then you can press the <INFO> button to turn off the screen (p.84).

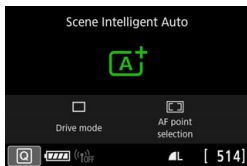



## Q Quick Control for Shooting Functions

You can directly select and set the shooting functions displayed on the LCD monitor with intuitive operations. This is called Quick Control.

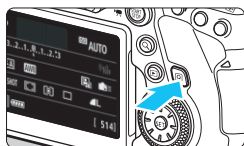

- 1 **Press the <Q> button** ( ).
  - ▶ The Quick Control screen will appear.

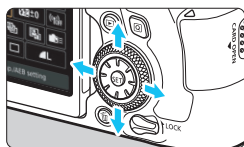

- 2 **Set the desired functions.**
  - Press the <▲> <▼> <◀> <▶> keys to select a function.
  - ▶ The settings of the selected function and Feature guide (p.90) will appear.
  - Turn the <◀> or <▶> dial to change the setting.

### ● Basic Zone modes



### ● Creative Zone modes



- 3 **Take the picture.**
  - Press the shutter button completely to take the picture.
  - ▶ The captured image will be displayed.



- For the functions settable in Basic Zone modes and their setting procedures, see page 126.
- You can also tap on the screen for Quick Control settings (p.67).

## Functions Settable with the Quick Control

### ● Creative Zone modes

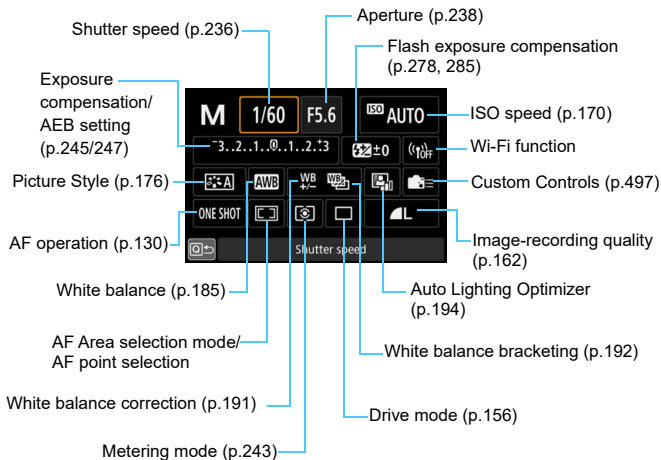

### ● Basic Zone modes (Sample screen)

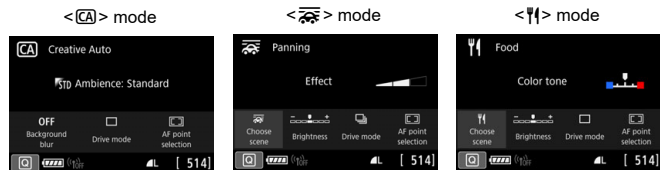

- In Basic Zone modes, the settable Quick Control functions vary depending on the shooting mode (p.127). The settable Quick Control functions in Basic Zone modes are **[Ambience-based shots]**, **[Background blur]**, **[Drive mode]**, **[AF point selection]**, **[Effect]** (Panning), **[Brightness]**, and **[Color tone]**.
- For the Quick Control screen, see page 86.

## Quick Control

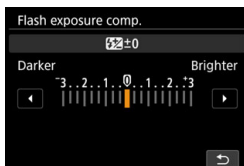

- Select the desired function and press  $\langle \text{SET} \rangle$ . The function setting screen will appear.
- Turn the  $\langle \text{DIAL} \rangle$  or  $\langle \text{DIAL} \rangle$  dial, then press the  $\langle \text{LEFT} \rangle$   $\langle \text{RIGHT} \rangle$  keys to change the setting. There are also functions that are set by pressing a button following these operations.
- Press  $\langle \text{SET} \rangle$  to finalize the setting and return to the previous screen.
- When you select  $\langle \text{MENU} \rangle$  (p.497),  $\langle \text{INFO} \rangle$  (p.134), or  $\langle \text{INFO} \rangle$ , and press the  $\langle \text{MENU} \rangle$  button to exit the setting.



For details on the Wi-Fi functions, refer to the “Wi-Fi (Wireless Communication) Function Instruction Manual” (p.4).

## MENU Menu Operations and Configurations

You can configure various settings with the menus such as the image-recording quality, date/time, etc.

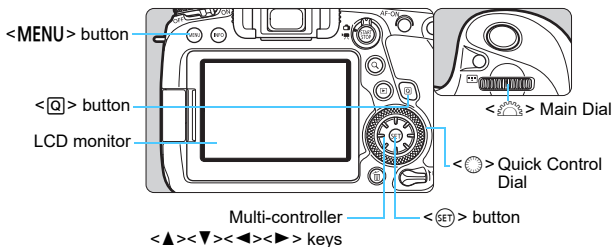

### Basic Zone Modes Menu Screen

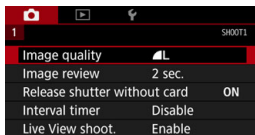
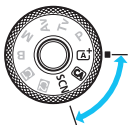

\* In Basic Zone modes, some tabs and menu items do not appear.

### Creative Zone Modes Menu Screen

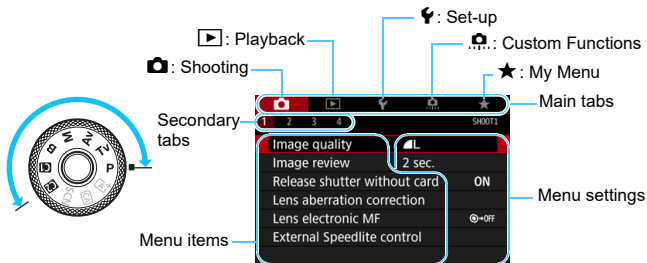

## Menu Setting Procedure

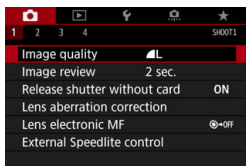

### 1 Display the menu screen.

- Press the <MENU> button to display the menu screen.

### 2 Select a tab.

- Each time you press the <Q> button, the main tab (group of functions) will switch.
- Press the Multi-controller's <◀> <▶> keys to select a secondary tab.
- For example, the [3] tab in this manual refers to the screen displayed when the [Shooting] tab's third box [3] from the left is selected.

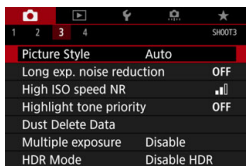

### 3 Select the desired item.

- Press the Multi-controller's <▲> <▼> keys to select the item, then press <SET>.



### 4 Select the setting.

- Press the <▲> <▼> or <◀> <▶> keys to select the desired setting.
- The current setting is indicated in blue.

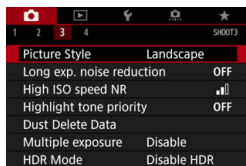

### 5 Set the setting.

- Press <SET> to set it.

### 6 Exit the setting.

- Press the <MENU> button to exit the menu and return to shooting-ready state.

- The description of menu functions hereafter assumes that you have pressed the <MENU> button to display the menu screen.
- You can also tap on the menu screen or turn the <⏏> or <⏏> dial to operate the menu.
- To cancel the operation, press the <MENU> button.
- For details about each menu item, see page 534.

## Dimmed Menu Items

Example: Highlight tone priority

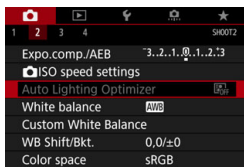

Dimmed menu items cannot be set. The menu item is dimmed if another function setting is overriding it.

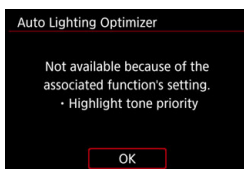

You can see the overriding function by selecting the dimmed menu item and pressing <⏏>.

If you cancel the overriding function's setting, the dimmed menu item will become settable.

- You may not be able to see the overriding function for certain dimmed menu items.

- With [**F5: Clear all camera settings**], you can reset the menu functions to the default settings (p.75).

## Operating the Camera with Touch Screen

You can operate the camera by tapping on the LCD monitor (touch-sensitive panel) with your fingers.

### Tap

#### Sample Screen (Quick Control)

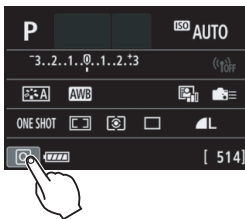

- Use your finger to tap on (touch briefly and then remove your finger from) the LCD monitor.
- By tapping, you can select menus, icons, etc. displayed on the LCD monitor.
- For example, when you tap on [**Q**], the Quick Control screen appears. By tapping on [**Q**➔], you can return to the preceding screen.

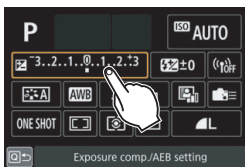

#### Examples of operations possible by tapping on the screen

- Setting menu functions after pressing the <MENU> button
- Quick Control
- Setting the function after pressing the <AF>, <DRIVE>, <ISO>, <AF-ON>, or <AF-ON> button
- Touch AF in Live View shooting and movie shooting
- Touch Shutter in Live View shooting
- Setting functions in Live View shooting and movie shooting
- Playback operations

 If [**4: Beep**] is set to [**Touch** , the beep will not sound for touch operations (p.73).

## Drag

### Sample Screen (Menu screen)

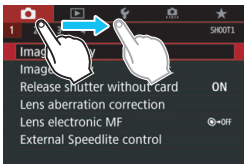

- Slide your finger while touching the LCD monitor.

### Sample Screen (Scale display)

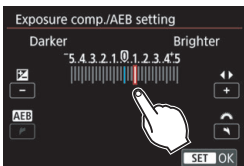

### Examples of operations possible by dragging your finger on the screen

- Selecting a menu tab or item after pressing the <MENU> button
- Setting with scale display
- Quick Control
- Selecting AF points (except with Live View shooting)
- Setting shooting functions for Live View shooting and movie shooting
- Playback operations

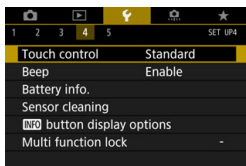

**MENU** Setting the Touch Control Response**1** Select [Touch control].

- Under the [4] tab, select [Touch control], then press <SET>.

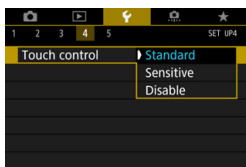
**2** Set the touch control response setting.

- Select the desired setting, then press <SET>.
- [Standard] is the normal setting.
- [Sensitive] provides a more reactive touch screen response than [Standard]. Try using both settings and select the one you prefer.
- To disable touch operations, select [Disable].

**⚠** Cautions for Touch Control Operations

- Since the LCD monitor is not pressure sensitive, do not use any sharp objects, such as your fingernail or a ballpoint pen, for touch operations.
- Do not use wet fingers for touch operations.
- If the LCD monitor has any moisture or if your fingers are wet, the touch screen may not respond or malfunction may occur. In such a case, turn off the power and wipe off the moisture with a cloth.
- Attaching any commercially-available protective sheet or sticker on the LCD monitor may degrade the touch operation response.
- If you quickly perform touch operation when [Sensitive] is set, the touch operation response may be poor.

## MENU Formatting the Card

If the card is new or was previously formatted by another camera or computer, format the card with this camera.

**!** When the card is formatted, all images and data on the card will be erased. Even protected images will be erased, so make sure there is nothing you need to keep. If necessary, transfer the images and data to a computer, etc. before formatting the card.

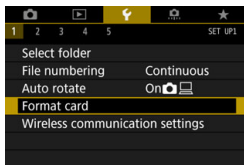

### 1 Select [Format card].

- Under the [**1**] tab, select [**Format card**], then press < **SET** >.

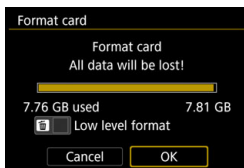

### 2 Format the card.

- Select [**OK**], then press < **SET** >.
- ▶ The card will be formatted.

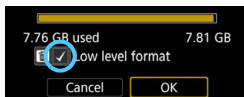

- For low-level formatting, press the < **✓** > button to add a checkmark < **✓** > to [**Low level format**], then select [**OK**].

- The card capacity displayed on the card format screen may be smaller than the capacity indicated on the card.
- This device incorporates exFAT technology licensed from Microsoft.



## Format the card in the following cases:

- The card is new.
- The card was formatted by a different camera or a computer.
- The card is full of images or data.
- A card-related error is displayed (p.567).

### Low-level Formatting

- Perform low-level formatting if the card's writing or reading speed seems slow or if you want to totally erase the data on the card.
- Since low-level formatting will format all recordable sectors on the card, the formatting will take longer than normal formatting.
- You can stop the low-level formatting by selecting [**Cancel**]. Even in this case, normal formatting will already be complete and you can use the card as usual.

### ● Card's file formats

SD/SDHC cards will be formatted in FAT32. SDXC cards will be formatted in exFAT.

When shooting a movie with a card formatted in exFAT, the movie will be recorded in a single file (instead of being split into multiple files) even if it exceeds 4 GB. (The movie file will exceed 4 GB.)

- ⚠ ● If you format an SDXC card with this camera and then insert it into another camera, an error may be displayed and the card may become unusable. Certain computer operating systems or card readers may not recognize a card formatted in exFAT.
- When the card is formatted or data is erased, only the file management information is changed. The actual data is not completely erased. Be aware of this when selling or discarding the card. When discarding the card, perform low-level formatting or destroy the card physically to prevent personal data from being leaked.

# Before You Start

## MENU Disabling the Beeper

You can prevent the beeper from sounding when focus is achieved, during self-timer shooting, and during touch operations.

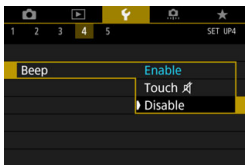

### 1 Select [Beep].

- Under the [**4**] tab, select [**Beep**], then press <SET>.

### 2 Select [Disable].

- Select [**Disable**], then press <SET>.
- ▶ The beeper will not sound.
- If [**Touch** ] is selected, the beeper will be silent only for touch operations.

## MENU Setting the Power-off Time/Auto Power Off

To save battery power, the camera turns off automatically after a set time of idle operation elapses. The default setting is 1 min., but this setting can be changed. If you do not want the camera to turn off automatically, set this to [**Disable**].

After the power turns off, you can turn on the camera again by pressing the shutter button or other buttons.

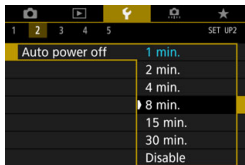

### 1 Select [Auto power off].

- Under the [**2**] tab, select [**Auto power off**], then press <SET>.

### 2 Set the desired time.

- Select the desired setting, then press <SET>.

 Even if [**Disable**] is set, the LCD monitor will turn off automatically after approx. 30 min. to save power. (The camera's power does not turn off.)

## MENU Setting the Image Review Time

You can set how long the image is displayed on the LCD monitor immediately after shooting. To keep the captured image displayed, set [**Hold**]. To not have the captured image displayed, set [**Off**].

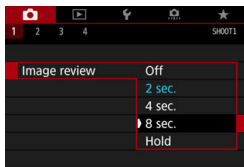

### 1 Select [Image review].

- Under the [**1**] tab, select [**Image review**], then press <SET>.

### 2 Set the desired time.

- Select the desired setting, then press <SET>.

If [**Hold**] is set, the image will be displayed until the auto power off time elapses.

## MENU Turning the LCD Monitor Off/On

The Quick Control screen (p.61) or electronic level (p.80) can be set to be displayed or not when you press the shutter button halfway during viewfinder shooting.

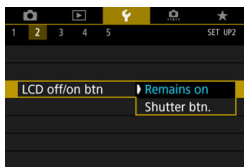

### 1 Select [LCD off/on btn].

- Under the [**2**] tab, select [**LCD off/on btn**], then press <SET>.

### 2 Set the desired setting.

- Select the desired setting, then press <SET>.

- [Remains on]:** The LCD monitor display does not turn off even when you press the shutter button halfway. To turn off the LCD monitor, press the <INFO> button.
- [Shutter btn.]:** When you press the shutter button halfway, the LCD monitor display turns off. When you let go of the shutter button, the display turns on.

## **MENU** Reverting the Camera to the Default Settings <sup>☆</sup>

The camera's shooting function settings and menu settings can be reverted to their defaults.

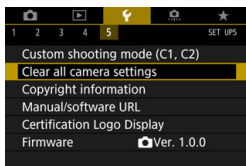

### 1 Select [Clear all camera settings].

- Under the [**5**] tab, select [**Clear all camera settings**], then press <SET>.





### 2 Select [OK].

- The camera settings will be reset to the default settings shown on pages 76-78.





For how to clear all the Custom Function settings, see page 468.

## Shooting Function Settings













AF operation	One-Shot AF
AF area selection mode	Automatic selection AF
Lens electronic MF	Disable after One-Shot AF
Metering mode	 (Evaluative metering)
<b>ISO speed settings</b>	
ISO speed	Auto
ISO speed range	Minimum: 100 Maximum: 40000
Auto range	Minimum: 100 Maximum: 12800
Minimum shutter speed for auto	Auto
Drive mode	 (Single shooting)
Exposure compensation/AEB	Canceled
Flash exposure compensation	Canceled
Multiple exposure	Disable
HDR mode	Disable HDR
Interval timer	Disable
Bulb timer	Disable
Anti-flicker shooting	Disable
Mirror lockup	Disable
<b>Viewfinder display</b>	
Electronic level	Hide
Grid display	Hide
Show/hide in viewfinder	Only flicker detection selected
Custom Functions	Unchanged
<b>External Speedlite control</b>	
Flash firing	Enable
E-TTL II flash metering	Evaluative flash metering
Flash sync. speed in Av mode	Auto

## Image Recording Settings

Image quality	 L
Aspect ratio	3:2
Picture Style	Auto
Auto Lighting Optimizer	Standard
<b>Lens aberration correction</b>	
Peripheral illumination correction	Enable
Chromatic aberration correction	Enable
Distortion correction	Disable
Diffraction correction	Enable
White balance	 AWB (Ambience priority)
Custom White Balance	Canceled
White balance shift	Canceled
White balance bracketing	Canceled
Color space	sRGB
Long Exposure Noise Reduction	Disable
High ISO speed noise reduction	Standard
Highlight tone priority	Disable
File numbering	Continuous
Dust Delete Data	Erased



## Camera Settings

Image review time	2 sec.
Release shutter without card	Enable
Image jump w/ 	 (10 images)
Highlight alert	Disable
AF point display	Disable
Playback grid	Off
Histogram display	Brightness
Magnification (Approx.)	2x (magnify from center)
Control over HDMI	Disable
Vertical image auto rotation	On  
<b>Wireless communication settings</b>	
Wi-Fi	Disable
Bluetooth function	Disable
Auto power off	1 min.
LCD brightness	     
LCD off/on btn	Remains on
Date/Time/Zone	Unchanged
Language	Unchanged
GPS	Disable
Video system	Unchanged
Shooting mode guide	Enable
Feature guide	Enable
Help text size	Small
Touch control	Standard
Beep	Enable
Auto cleaning	Enable
 button display options	Select both
 button LV display options	Unchanged
Multi function lock	 (Quick Control Dial)
Custom shooting mode	Unchanged
Copyright information	Unchanged
Configure: MY MENU	Unchanged
Menu display	Normal display

## Live View Shooting Settings

Live View shooting	Enable
AF operation	One-Shot AF
AF method	 +Tracking
Touch Shutter	Disable
Metering timer	8 sec.
Grid display	Hide
Exposure simulation	Enable
Silent LV shooting	Mode 1

## Movie Shooting Settings

<b>Movie recording size</b>	NTSC: PAL:
<b>Sound recording</b>	Auto
<b>Wind filter</b>	Auto
<b>Attenuator</b>	Disable
<b> ISO speed settings</b>	
<b>ISO speed</b>	Auto
<b>ISO speed range</b>	Minimum: 100 Maximum: 25600
<b>ISO Auto</b>	Maximum 25600
<b> ISO Auto</b>	Maximum 12800

<b>Movie Servo AF</b>	Enable
<b>AF method</b>	+Tracking
<b>Movie Servo AF track sensitivity</b>	0
<b>Movie Servo AF Speed</b>	
<b>When active</b>	Always on
<b>AF speed</b>	0 (Standard)
<b>Metering timer</b>	8 sec.
<b>Grid display</b>	Hide
<b> button function</b>	
<b>Video snapshot</b>	Disable
<b>Time-lapse movie</b>	Disable
<b>Movie digital IS</b>	Disable
<b>Remote control shooting</b>	Disable

## MENU Displaying the Grid in the Viewfinder

You can display a grid in the viewfinder to help you check the camera tilt or compose the shot.

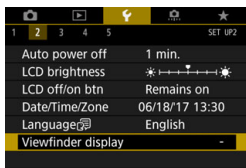

### 1 Select [Viewfinder display].

- Under the [**F2**] tab, select [Viewfinder display], then press <SET>.

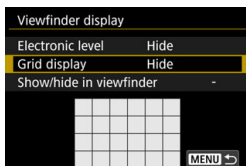

### 2 Select [Grid display].

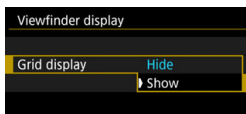

### 3 Select [Show].

- When you exit the menu, the grid will appear in the viewfinder.

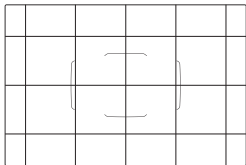

- You can display a grid on the LCD monitor during Live View shooting and before you start shooting a movie (p.302, 377).
- If the [**F2: Viewfinder display**] setting is changed from the default, there will be an asterisk "\*" on the right edge of [**F2: Viewfinder display**].

## MENU Displaying the Electronic Level

You can display the electronic level on the LCD monitor and in the viewfinder to help you correct the camera tilt.

### Displaying the Electronic Level on the LCD Monitor

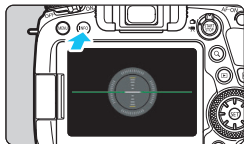

#### 1 Press the <INFO> button.

- Each time you press the <INFO> button, the screen display will change.
- Display the electronic level.
- If the electronic level does not appear, set [4: INFO button display options] so that the electronic level can be displayed (p.84).

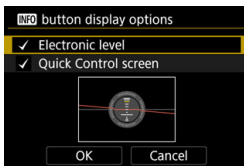

#### 2 Check the camera's tilt.

- The horizontal and vertical tilts are displayed in 1° increments.
- When the red line turns green, it indicates that the tilt is almost corrected.

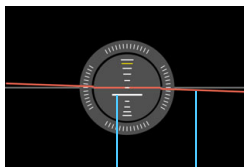

Vertical

Horizontal

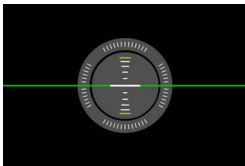

- Even when the tilt is corrected, there may be a margin of error of approx.  $\pm 1^\circ$ .
- If the camera is very tilted, the electronic level's margin of error will be larger.

During Live View shooting and before movie shooting, you can also display the electronic level as described above (except with  $\text{L}^+$ +Tracking).

## MENU Displaying the Electronic Level in the Viewfinder

An electronic level can be displayed on the upper part of the viewfinder. Since this indicator is displayed during shooting, you can take the picture while checking the camera tilt.

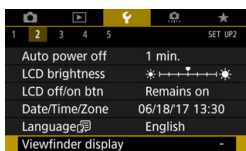

### 1 Select [Viewfinder display].

- Under the [**⚡**] tab, select [Viewfinder display], then press **<SET>**.



### 2 Select [Electronic level].



### 3 Select [Show].

### 4 Press the shutter button halfway.

- The electronic level will be displayed on the upper part of the viewfinder.
- This level also works with vertical shooting.

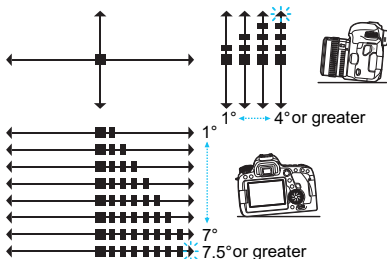

Even when the tilt is corrected, there may be a margin of error of approx.  $\pm 1^\circ$ .

If the [**⚡**: Viewfinder display] setting is changed from the default, there will be an asterisk "\*" on the right edge of [**⚡**: Viewfinder display].

## MENU Setting the Viewfinder Information Display ☆

The shooting function settings (Battery level, Shooting mode, AF operation, Image quality (image type), Drive mode, Metering mode, Flicker detection) can be displayed in the viewfinder.

By default, only Flicker detection is checkmarked [✓].

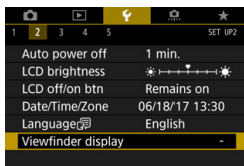

### 1 Select [Viewfinder display].

- Under the [F2] tab, select [Viewfinder display], then press <SET>.

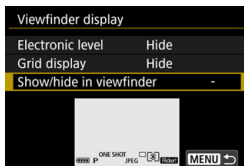

### 2 Select [Show/hide in viewfinder].

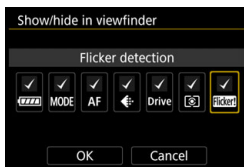

### 3 Checkmark [✓] the information to be displayed.



- Select the information to display and press <SET> to add a checkmark [✓].
- Repeat this procedure to add a checkmark [✓] to all the information to be displayed. Then select [OK].
- ▶ When you exit the menu, the checkmarked information will appear in the viewfinder (p.31).





If no card is inserted in the camera, the image-recording quality (image type: JPEG/RAW) will not be displayed.



- Regardless of whether it is checkmarked, the respective information will appear in the viewfinder in the following cases: when you change the shooting mode, when you press the <AF>, <DRIVE>, or <Ⓢ> button, when you operate the lens's focus mode switch, and when a lens equipped with the electronic manual focusing function is used and the AF and MF switches as the lens focusing ring is turned (p.155).
- Even if **[Battery]** is not checkmarked, the battery check icon (  /  ) will be displayed in the viewfinder when the battery level is low.
- If the [**2: Viewfinder display**] setting is changed from the default, there will be an asterisk "\*" on the right edge of [**2: Viewfinder display**].

# INFO Button Functions

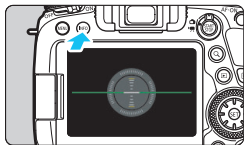

During viewfinder shooting, when you press the <INFO> button with the camera being ready to shoot, you can toggle the display between the electronic level (p.80) and Quick Control screen (p.86).

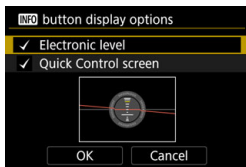

[**INFO button display options**] under the [**4**] tab enables you to select the options displayed when the <INFO> button is pressed.

- Select the desired display option, then press <SET> to add a checkmark [✓].
- Then select [**OK**] to register the setting.

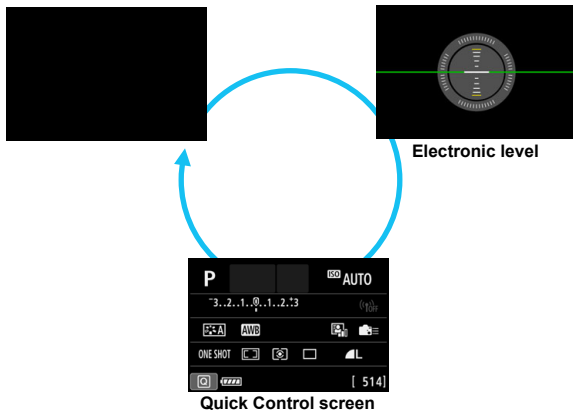





- If you turn off the power with the electronic level or Quick Control screen displayed, the same screen will be displayed when you turn on the power again. To cancel this function, press the <INFO> button a number of times until the screen is blank, then turn off the power switch.
- You cannot remove the checkmarks from both items.
- Even if you set the [**Electronic level**] not to be displayed, it will still be displayed for Live View shooting and movie shooting by pressing the <INFO> button. Note that depending on the setting for [**5: AF method**], electronic level may not be displayed.
- Pressing the <Q> button enables Quick Control (p.61).
- During Live View shooting or movie shooting, the items displayed under the [**4**] tab will change to [**INFO button LV display options**] (p.298).

## Quick Control Screen

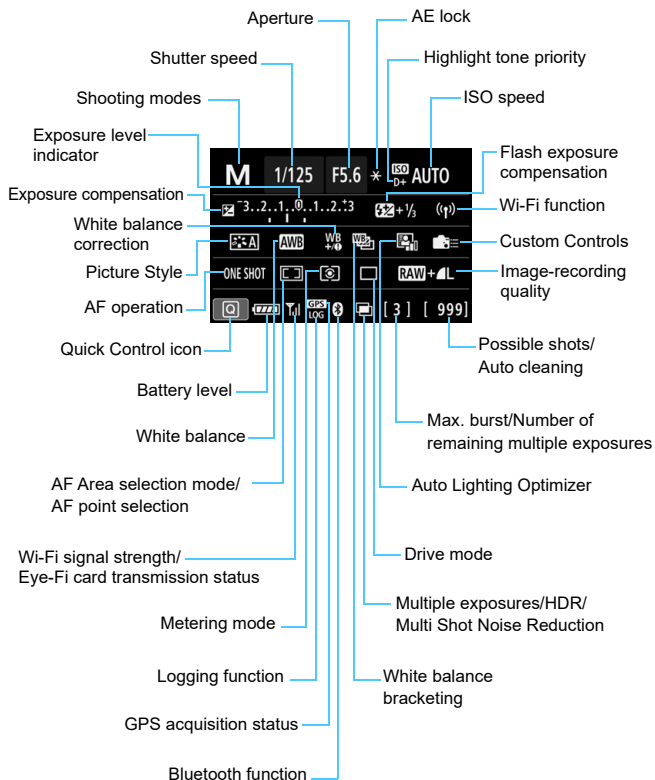

\* The display will show only the settings currently applied.

## Button Operations with Quick Control Screen Displayed

When you press the <AF>, <DRIVE>, <ISO>, <☉>, <☰>, or <☲> button, the setting screen appears and you can set it with <☰>, <☲>, <☱>, or <☴> button.

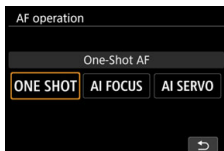

AF operation

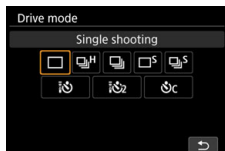

Drive mode

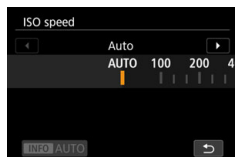

ISO speed

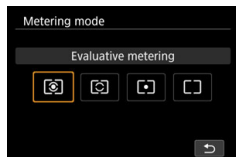

Metering mode

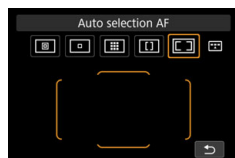

AF Area / AF point selection

 If nothing is displayed even if you press a button, press the <INFO> button to display the electronic level or Quick Control screen. Then press any of the above buttons to display the respective screen.

# LOCK Setting the Multi Function Lock

By setting the <LOCK> switch upward, you can prevent the settings from being changed by accidentally operating the Main Dial, Quick Control Dial, or Multi-controller or by inadvertently tapping on the touch screen.

For details on the Multi function lock switch, see page 59.

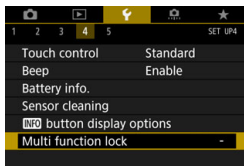

## 1 Select [Multi function lock].

- Under the [F4] tab, select [Multi function lock], then press <SET>.



## 2 Add a checkmark [✓] to the camera control to be locked.

- Select a camera control and press <SET> to add a checkmark [✓].
- Select [OK].
- ▶ When the <LOCK> switch is set upward, the checkmarked [✓] camera controls will be locked.



- When the <LOCK> switch is set upward and you try to operate one of the locked camera controls, <L> will be displayed in the viewfinder and on the LCD panel. On the Quick Control screen (p.61), [LOCK] will be displayed. During Live View or movie shooting, [LOCK] will be displayed on the shooting screen.
- By default, the <DIAL> dial will be locked when the multi function lock switch is in the lock position.
- In Basic Zone modes, only [Touch control] is settable.
- You can operate the Quick Control (p.61) regardless of the Multi function lock setting.
- If it is changed from the default setting, an asterisk "\*" will be displayed on the right edge of [F4: Multi function lock].

# Setting the Shooting Mode Guide

When you turn the Mode Dial to select a shooting mode, a brief description (shooting mode guide) of the shooting mode can be displayed on the screen. During viewfinder shooting, the mode guide appears when the Quick Control screen or electronic level is displayed. By default, it is set to **[Enable]**.

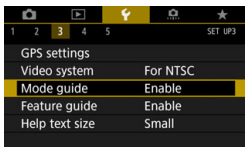

## 1 Select **[Mode guide]**.

- Under the [**3**] tab, select **[Mode guide]**, then press **<SET>**.

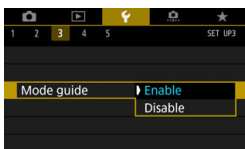

## 2 Select **[Enable]**.

- If you do not want the Mode guide to appear, select **[Disable]**.

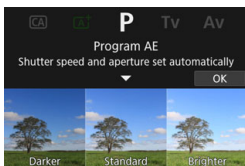

## 3 Turn the Mode Dial.

- A brief description of the selected shooting mode will appear.

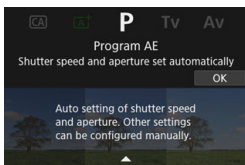

## 4 Press the **<▼>** key.

- A more detailed description will appear.
- To turn off the mode guide, press **<SET>** or press the shutter button halfway.

In the **<SCN>** mode, press **<SET>** in step 3 or 4, then select the shooting mode.

# Setting the Feature Guide

When using Quick Control, a brief description (feature guide) of the selected function can be displayed. The Feature guide can be displayed during viewfinder shooting, Live View shooting, and movie shooting. By default, it is set to [Enable].

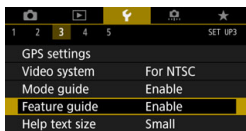

## 1 Select [Feature guide].

- Under the [**⚡**3] tab, select [Feature guide], then press <[SET]>.

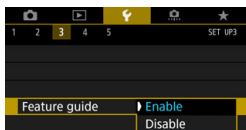

## 2 Select [Enable].

- If you do not want the Feature guide to appear, select [Disable].

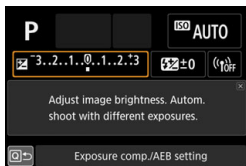

## 3 With the camera ready to shoot, press the <[Q]> button.

- Exit the menu and press the <[Q]> button in the shooting-ready state.
- ▶ When you press <[Q]> to select an item, the Feature guide will appear after a moment.

### Viewfinder shooting

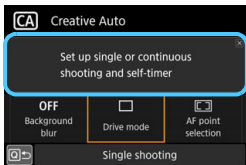

### Live View/Movie shooting



- With certain functions, the feature guide is displayed also in the secondary screen.
- Tap on the Feature guide to turn it off.

## ? Help

When [INFO Help] is displayed at the bottom of the menu screen, the feature's description (Help) can be displayed. Press the <INFO> button to display the Help. Press it again to turn off the Help display. If the Help fills more than one screen, a scroll bar will appear on the right edge. In such a case, press <▲> <▼> keys or turn the <◻> dial to scroll.

### ● Example: [📷3: High ISO speed NR]

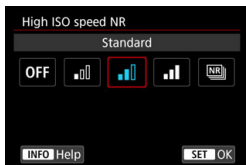

INFO  
➔

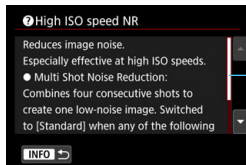

Scroll bar

### ● Example: [🔒4: Multi function lock]



INFO  
➔

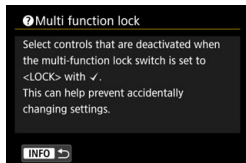

### ● Example: [📷.C.Fn II-1: Tracking sensitivity]

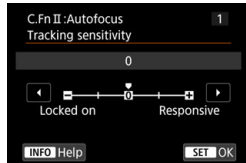

INFO  
➔

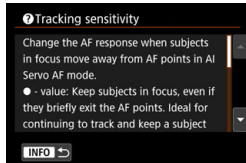

## Help Display Text Size

You can select the text size for the Help display. By default, it is set to **[Small]**.

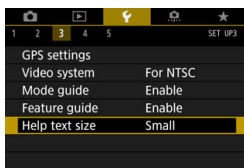

### 1 Select [Help text size].

- Under the [**Y**3] tab, select [**Help text size**], then press <SET>.



### 2 Set the text size.

- Select [**Small**] or [**Standard**], then press <SET>.

- Example: [**3**: High ISO speed NR]

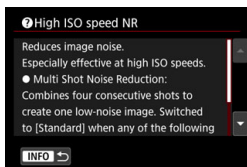

Text size: Small

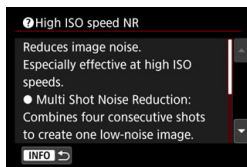

Text size: Standard





# Basic Shooting

This chapter describes how to use the Basic Zone modes on the Mode Dial for best results.

With Basic Zone modes, all you do is point and shoot, and the camera sets everything automatically (p.127, 526). Also, because advanced shooting function settings cannot be changed, you can enjoy shooting photographs without worrying about botched pictures due to misoperation.

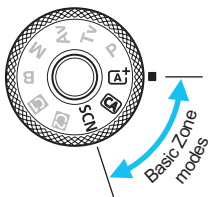
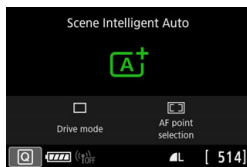

## Before Shooting in the <SCN> Mode

When you use the <SCN> mode for shooting with the LCD monitor turned off, press the <Q> button or <INFO> button to check which shooting mode is set, then start shooting.

## **[A<sup>+</sup>]** Fully Automatic Shooting (Scene Intelligent Auto)

**[A<sup>+</sup>]** is a fully automatic mode. The camera analyzes the scene and sets the optimum settings automatically. It can also adjust focus automatically on either the still or moving subject by detecting the motion of the subject (p.97).



### 1 Set the Mode Dial to **[A<sup>+</sup>]**.

- Turn the Mode Dial while holding down the lock release button at the center.
- When the shooting mode description appears on the LCD monitor, press **[SET]** to hide it (p.89).

Area AF frame

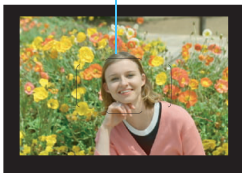

### 2 Aim the Area AF frame over the subject.

- All the AF points will be used to focus, and the camera will basically focus on the closest object.
- Aiming the center of the Area AF frame over the subject will make focusing easier.

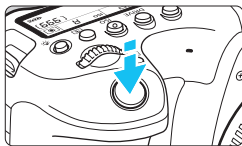

### 3 Focus on the subject.

- Press the shutter button halfway. The lens elements will shift to focus.
- ▶ When achieving focus, the AF point that has achieved focus will be displayed. At the same time, the beeper will sound and the focus indicator **[●]** in the viewfinder will light up.
- ▶ In low light, the AF point(s) will light up briefly in red.



Focus indicator



## 4 Take the picture.

- Press the shutter button completely to take the picture.
- ▶ The captured image will be displayed for approx. 2 sec. on the LCD monitor.



- The **<A<sup>+</sup>>** mode makes the colors look more impressive in nature, outdoor, and sunset scenes. If you do not obtain the desired color tones, change the mode to a Creative Zone mode (p.36) and select a Picture Style other than **<P-A>**, then shoot again (p.176).
- By pressing the **<Q>** button, you can use Quick Control for **[Drive mode]** and **[AF point selection]**. For the setting procedures, refer to those for the **<CA>** mode described on pages 100-104.



## FAQ

- **The focus indicator <●> blinks and focus is not achieved.**  
Aim the Area AF frame over an area with good contrast, then press the shutter button halfway (p.56). If you are too close to the subject, move away and shoot again.
- **Even when focus is achieved, the AF points do not light up in red.**  
The AF points light up in red only when focus is achieved in low light or with a dark subject.
- **Multiple AF points light up simultaneously.**  
Focus has been achieved at all those points. You can take the picture as long as an AF point covering the target subject is lighting up.

- **The beeper continues to beep softly. (The focus indicator <●> does not light up.)**  
It indicates that the camera is focusing continuously on a moving subject. (The focus indicator <●> does not light up.) You can take sharp pictures of a moving subject.  
Note that focus lock (p.97) will not work in this case.
- **Pressing the shutter button halfway does not focus the subject.**  
If the focus mode switch on the lens is set to <MF> (manual focus), set it to <AF> (autofocus).
- **The shutter speed display is blinking.**  
Since it is too dark, taking the picture may result in a blurred subject due to camera shake. Using a tripod or a Canon EX-series Speedlite (sold separately, p.278) is recommended.
- **When the external flash was used, the bottom part of the picture came out unnaturally dark.**  
If a hood is attached to the lens, it may obstruct the flash light. If the subject is close, detach the hood before taking the picture with flash.







## Minimizing Blurred Photos

- Silent single shooting (p.157), Single shooting in Live View shooting, etc. are effective. Mirror lockup (p.265) is also effective when the shooting mode is set to one of the Creative Zone modes.
- For continuous shooting, using Silent continuous shooting (p.157) or Live View continuous shooting is effective.
- Use a sturdy tripod that can bear the weight of the shooting equipment. Mount the camera securely on the tripod.
- Using a remote switch or a remote controller is recommended (p.271, 273).

## Full Auto Techniques (Scene Intelligent Auto) ■

### Recomposing the Shot



Depending on the scene, positioning the subject toward the left or right to include a balanced background will result in a picture with better perspective. In the  mode, pressing the shutter button halfway to focus on a still subject will lock the focus on that subject. Recompose the shot while keeping the shutter button pressed halfway, and then press the shutter button completely to take the picture. This is called “focus lock”. Focus lock is also possible in other Basic Zone modes (except in these  modes:  >  > ).

### Shooting a Moving Subject



In the  mode, if the subject moves (distance to camera changes) during or after focusing, AI Servo AF will take effect to focus on the subject continuously. (The beeper will continue beeping softly.) As long as you keep the Area AF frame positioned over the subject while pressing the shutter button halfway, focusing will be continuous. At the decisive moment, press the shutter button completely to take the picture.

## Live View Shooting

You can shoot while viewing the image on the LCD monitor. This is called “Live View shooting”. For details, see page 289.

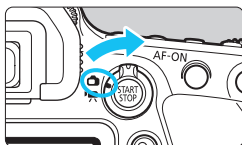

- 1 Set the Live View shooting/Movie shooting switch to <img alt="camera icon" data-bbox="750 210 775 235"/>.**

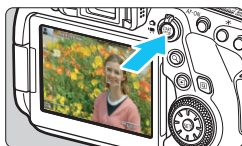

- 2 Display the Live View image on the LCD monitor.**

- Press the <START/STOP> button.
- ▶ The Live View image will appear on the LCD monitor.



- 3 Focus on the subject.**

- Press the shutter button halfway to focus.
- ▶ When focus is achieved, the AF point will turn green and the beeper will sound.

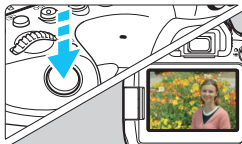

- 4 Take the picture.**

- Press the shutter button completely.
- ▶ The picture is taken and the captured image is displayed on the LCD monitor.
- ▶ When the playback display ends, the camera will return to Live View shooting automatically.
- Press the <START/STOP> button to exit the Live View shooting.

You can also rotate the LCD monitor to shoot at different angles. For details, see page 46.



Normal angle



Low angle



High angle

## **CA** Creative Auto Shooting

<CA> is a fully-automatic shooting mode that is a step more advanced from <A+>. You can first adjust the photo's ambience, background blur, etc. before shooting.

By pressing the <Q> button, you can set 1. Ambience-based shots, 2. Background blur setting, 3. Drive mode, and 4. AF point selection with Quick Control.

\* <CA> stands for Creative Auto.



### 1 Set the Mode Dial to <CA>.

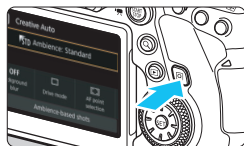

### 2 Press the <Q> button (10).

- ▶ The Quick Control screen (p.126) will appear.

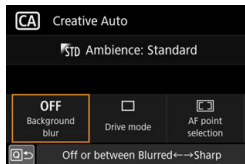

### 3 Set the desired functions.

- Press the <▲> <▼> or <◀> <▶> keys to select a function.
- ▶ The settings of the selected function and Feature guide (p.90) will appear.
- For the setting procedure and details on each function, see pages 101-104.

### 4 Take the picture.

- Press the shutter button completely to take the picture.
- When you use the Live View function to see the resulting effects on the LCD monitor while shooting, see page 105.



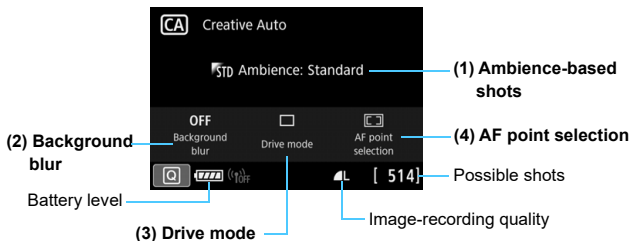

### (1) Ambience-based shots



You can select and shoot with the ambience you want to convey in your images. Turn the <☀> or <🕒> dial to select the ambience.

With the (1) item selected, press <⊙> to display the screen shown on the left. You can then select the ambience from the displayed list. Press the <▲> <▼> keys to select the desired ambience.

Note that you can preview the resulting effect of “Ambience-based shots” before shooting by pressing the <START STOP> button and switching to Live View shooting (p.105).

Ambience	Ambience Effect
STD Ambience: Standard	No setting
V Vivid	Low / Standard / Strong
S Soft	Low / Standard / Strong
W Warm	Low / Standard / Strong
I Intense	Low / Standard / Strong
C Cool	Low / Standard / Strong
B Brighter	Low / Medium / High
D Darker	Low / Medium / High
M Monochrome	Blue / B/W / Sepia

## Ambience Settings

### **STD Ambience: Standard**

This provides standard image characteristics.

### **V Vivid**

The subject looks crisp, sharp and vivid. Effective for making the picture look more impressive than with [**STD Ambience: Standard**].

### **S Soft**

The subject is less defined, giving the picture a softer and daintier look. Good for portraits, pets, flowers, etc.

### **W Warm**

The subject is less defined with a warmer color cast, giving the picture a warmer and gentler look. Good for portraits, pets, and other subjects to which you want to give a warm look.

### **I Intense**

While the overall brightness is slightly lowered, the subject is emphasized for a more intense feeling in the picture. Effective for making the human or living subject stand out more.

### **C Cool**

The overall brightness is slightly lowered with a cooler color cast in the picture. Effective for making a subject in the shade look more calm and impressive.

### **B Brighter**

The picture looks brighter.

### **D Darker**

The picture looks darker.

### **M Monochrome**

The picture becomes monochrome. You can select the monochrome color to be blue, black and white, or sepia.

## (2) Background blur

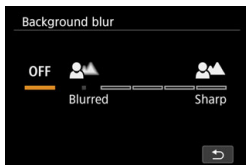

You can adjust the degree of background blur. Turn the < > or < > dial to set the effect.

With the (2) item on page 101 selected, press < > to display the screen shown on the left. While looking at the gauge, you can turn the < > or < > dial to set the degree.

Note that you can preview the resulting effect of “Background blur” before shooting by pressing the < > button and switching to Live View shooting (p.106).

- OFF** : The camera sets the aperture automatically to match the brightness. You can take the picture with the degree of background blur automatically set by the camera.
- Blurred** : The further left (Blurred end) you set the orange bar, the more blurred the background of the subject in the picture will be.
- Sharp** : The further right (Sharp end) you set the orange bar, the sharper the background of the subject in the picture will be.



- Depending on the lens used and shooting conditions, the background in the picture may not look as blurred or sharp as expected.
- This function cannot be set if you use an external flash.
- Depending on the speed of the lens used (open aperture f/number), certain setting positions may not be selectable.



If you want to blur the background, see “Shooting Tips” for “Shooting Portraits” on page 109 for shooting.

### (3) Drive mode

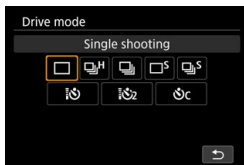

You can select single shooting, continuous shooting, or self-timer. Turn the < > or < > dial to select the desired mode.

Pressing < > will display the screen shown on the left. Turn the < > dial to select the desired setting.

For drive modes, see page 156.

### (4) AF point selection

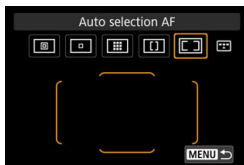

Turn the < > or < > dial to select the desired AF Area selection mode.

Pressing < > will display the screen shown on the left. You can then select the AF Area selection mode and AF point.

If you then press the < > button in this status, you can select the AF Area selection mode. When the AF Area selection mode is set to other than **[Auto selection AF]**, you can use < > to select the AF point or zone.

For AF area selection modes, see pages 134-136. For AF point selection, see page 137.

## Using Effect Preview in Live View Shooting

In the <CA> mode, when you set the [Ambience-based shots] or [Background blur], shooting while checking the resulting effect on the Live View image is recommended.



### 1 Display the Live View image.

- Set the Live View/Movie shooting switch to <CAM>, then press the <START STOP> button.
- Press the shutter button halfway, then focus on the subject.



### 2 Press the <Q> button.

- ▶ The Quick Control screen will appear (10).



### 3 Select the desired ambience.

- Press the <▲> <▼> keys to select [Ambience-based shots].
- Turn the <☀> or <☾> dial to select the ambience (p.101).
- ▶ The LCD monitor will display how the image will look with the selected ambience.



### 4 Set the ambience effect.

- Press the <▲> <▼> keys to select [Effect].
- Turn the <☀> or <☾> dial to select the desired degree or setting of the effect.

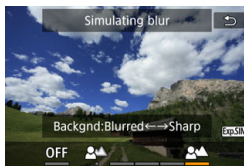

## 5 Set [Background Blur].

- Press the <Q> button to exit the Quick Control.
- Turn the <G> or <D> dial to adjust the blur while checking it on the screen (p.103). While you adjust it, [Simulating blur] will be displayed.

## 6 Take the picture.

- Press the shutter button completely.
- To return to viewfinder shooting, press the <START/STOP> button to exit Live View shooting.

- The Live View image shown with the ambience setting applied will not look exactly the same as the captured image.
- If the <Exp.SIM> icon (p.293) blinks during [Simulating blur], the simulated image displayed may have more noise or may be darker than the actual image being recorded.
- If you use an external flash, the ambience effect may look less pronounced.
- In bright outdoors, the Live View image you see on the LCD monitor may not have the same brightness or ambience as the actual image captured. Set the brightness of the LCD monitor to the level "4" under [42: LCD brightness] to avoid ambient brightness as much as possible when checking the resulting effect.
- If you change the shooting mode or turn the power switch to <OFF>, the [Ambience], [Background blur], [Drive mode], and [AF point selection] settings will revert to their default settings.

## [Menu Icon] <SCN> Mode [Brightness] and [Color tone]

When the Mode Dial is set to the <SCN> mode, you can adjust the [Brightness] and [Color tone] with the shooting mode. In step 3, when you select [Brightness] or [Color tone], you can adjust the [Brightness] to Darker/Brighter (3 steps each) or the [Color tone] to Cool tone/Warm tone (2 steps each) while watching the Live View image.

# SCN: Special Scene Mode

The camera will automatically choose the appropriate settings when you select a shooting mode for your subject or scene.

\* <SCN> stands for Special Scene.



1 Set the Mode Dial to <SCN>.

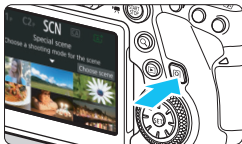

2 Press the <Q> button (10).

▶ The Quick Control screen will appear.

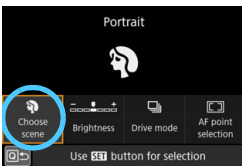

3 Select [Choose scene].

- Press the <▲> <▼> or <◀> <▶> keys to select [Choose scene], then press <SET>.

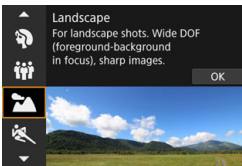

4 Select a shooting mode.

- Press the <▲> <▼> keys to select the shooting mode, then press <SET>.
- You can also select the shooting mode by turning the <☀> or <🕒> dial.



Cautions for the shooting modes are on page 122. Read the cautions before shooting.

## SCN Modes

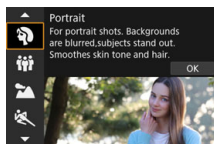

**👤: Portrait** (p.109)

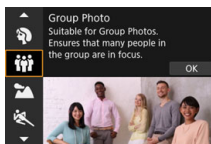

**👥: Group Photo**  
(p.110)

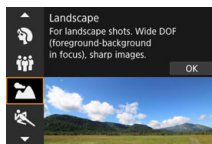

**🏞️: Landscape** (p.111)

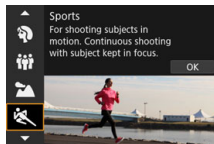

**🏃: Sports** (p.112)



**👧: Kids** (p.113)

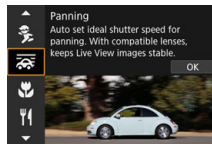

**🚗: Panning** (p.114)

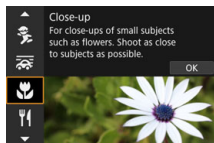

**🌸: Close-up** (p.116)

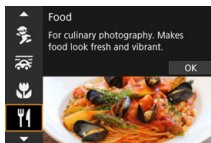

**🍴: Food** (p.117)



**🕯️: Candlelight** (p.118)

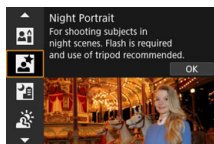

**🌃: Night Portrait**  
(p.119)

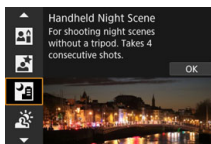

**🌃: Handheld Night Scene**  
(p.120)

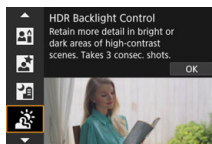

**📖: HDR Backlight Control**  
(p.121)



## SCN: Shooting Portraits

The <> (Portrait) mode blurs the background to make the human subject stand out. It also makes skin tones and hair look softer.

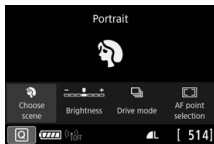

### Shooting Tips

- **Select the location where the distance between the subject and the background is the farthest.**  
The further the distance between the subject and background, the more blurred the background will look. The subject will also stand out better against an uncluttered dark background.
- **Use a telephoto lens.**  
If you have a zoom lens, use the telephoto end to fill the frame with the subject from the waist up. Move in closer if necessary.
- **Focus on the face.**  
Check that the AF point covering the face lights up. For close-ups of the face, focus on the eyes.



The default setting is <> (Low-speed continuous shooting). If you keep holding down the shutter button, you can shoot continuously (max. approx. 3.0 shots/sec.) to capture changes in the subject's facial expression and pose.

## SCN: Shooting Group Photos

Use the  (Group Photo) mode to shoot group photos. You can take a picture in which both the people in the front and people in the back are all in focus.

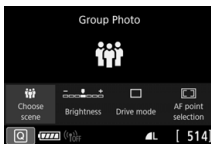

### Shooting Tips

- **Use a wide-angle lens.**

When using a zoom lens, use the wide-angle end to make it easy to get all the people in the group in focus at once, from the front row to the back. Also, if you place a little distance between the camera and the subjects (so that the subjects' entire bodies are in the shot), the focus range increases in depth.

- **Take multiple shots of the group.**

It is recommended to shoot multiple photos in case some people close their eyes.



See the cautions on page 122.



- When shooting indoors or in low-light, hold the camera steady or use a tripod to prevent camera shake.
- By pressing the  button and selecting [**Brightness**], you can adjust the image brightness.

## SCN: Shooting Landscapes

Use the  (Landscape) mode for expansive scenery or to have everything in focus from near to far. For vivid blues and greens, and very sharp and crisp images.

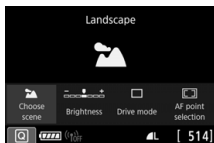

### Shooting Tips

- **With a zoom lens, use the wide-angle end.**  
When using a zoom lens, set the lens to the wide-angle end to make the objects near and far in focus. It also adds breadth to landscapes.
- **Shooting night scenes.**  
Shooting with  while handholding the camera may cause camera shake. Using a tripod is recommended.



See the cautions on page 122.

## SCN: Shooting Moving Subjects

Use the  (Sports) mode to shoot a moving subject, such as a running person or a moving vehicle.

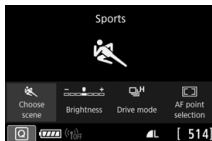

### Shooting Tips

- **Use a telephoto lens.**

Use of a telephoto lens is recommended to enable shooting from a distance.

- **Track the subject with the Area AF frame.**

After aiming the Area AF frame over the subject, press the shutter button halfway to start focusing. During autofocusing, the beeper will continue beeping softly. If focus cannot be achieved, the focus indicator  will blink.

- **Shoot continuously.**

The default setting is  (High-speed continuous shooting). At the decisive moment, press the shutter button completely to take the picture. If you keep holding down the shutter button, you can shoot continuously while maintaining autofocusing to capture changes in the subject's movement. (Viewfinder shooting: max. approx. 6.5 shots/sec., Live View shooting: max. approx. 4.0 shots/sec.)

 See the cautions on page 122.

## SCN: Photographing Children

To photograph the children running around, use <> (Kids). Skin tones will look healthy.

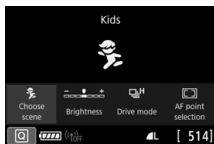

### Shooting Tips

- **Track the subject with the Area AF frame.**

After aiming the Area AF frame over the subject, press the shutter button halfway to start focusing. During autofocusing, the beeper will continue beeping softly. If focus cannot be achieved, the focus indicator <> will blink.



- **Shoot continuously.**

The default setting is <H> (High-speed continuous shooting). At the decisive moment, press the shutter button completely to take the picture. If you keep holding down the shutter button, you can shoot continuously while maintaining autofocusing to capture changes in the subject's facial expression and movement. (Viewfinder shooting: max. approx. 6.5 shots/sec., Live View shooting: max. approx. 4.0 shots/sec.)



See the cautions on page 122.

## SCN: Panning

If you want to take a picture with the feel of speed and a blurred motion effect on the subject's background, use < > (Panning). With Live View shooting, if you use a lens supporting the < > mode, subject blur is detected, corrected, and reduced.

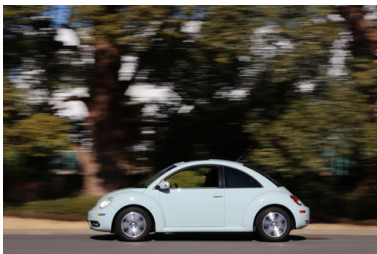
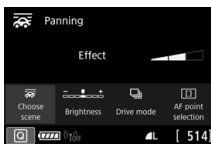

### Shooting Tips

- **Turn the camera to follow the moving subject.**

When shooting, turn the camera smoothly as you track the moving subject. Aim the AF point over the part of the moving subject where you want to focus, then press the shutter button halfway and keep holding it down as you turn the camera to match the subject's speed and movement. Press the shutter button completely while moving the camera to take the picture. Keep tracking the subject with the camera.

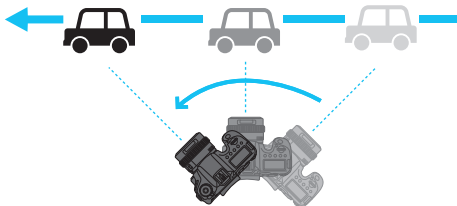



- **Set the level of background motion blur.**

With **[Effect]**, you can set the level of background motion blur. The **[Max]** setting will set a slower shutter speed to increase the background motion blur around the subject. If the subject blur is noticeable, set **[Effect]** to **[Med]** or **[Min]** to reduce the blur.



See the cautions on page 122.



- To see which lenses support the  mode, refer to the Canon Web site.
- When using a lens supporting the  mode during Live View shooting, subject blur can be corrected and the shutter speed will be set automatically according to the setting of **[Effect]**, regardless of the lens's Image Stabilizer setting.
- For viewfinder shooting, the AF Area selection mode's default setting is Large Zone AF with the "Center Zone" selected.
- With Live View shooting, [**2: AF method**] will be set automatically to **[Smooth zone]**.
- To prevent camera shake, it is recommended that you hold the camera with both hands, tighten your arms close to your body, and track the subject's movement smoothly to take pictures.
- This effect is most effective with trains, cars, etc. that move at a constant speed in one direction.
- Taking test shots or checking the image by playing it back immediately after shooting is recommended.
- By default,  (Low-speed continuous shooting) is set. When the decisive moment comes, press the shutter button completely. If you keep holding down the shutter button while moving the camera to follow the subject movement, you can shoot continuously while maintaining autofocus (Maximum approx. 4.3 shots/sec. with viewfinder shooting and approx. 2.7 shots/sec. with Live View shooting (at 1/30 sec. shutter speed with maximum aperture).)

## SCN: Shooting Close-ups

When you want to shoot flowers or small things up close, use the <> (Close-up) mode. To make small things appear much larger, use a macro lens (sold separately).

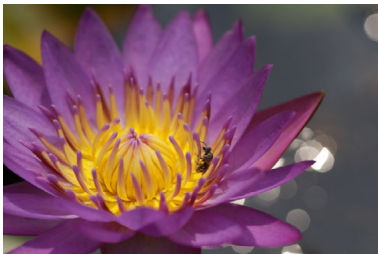
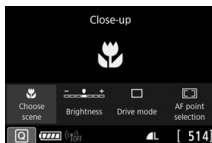



### Shooting Tips

- **Use a simple background.**

A simple background makes small objects such as flowers stand out better.

- **Move in as close as possible to the subject.**

Check the lens for its minimum focusing distance. The lens minimum focusing distance is measured from the <> (focal plane) mark on the top of the camera to the subject. If you are too close to the subject and focus cannot be achieved, the focus indicator <> will blink.

- **With a zoom lens, use the telephoto end.**

If you have a zoom lens, using the telephoto end will make the subject look larger.



## SCN: 🍴 Shooting Food

When you want to take pictures of food, use <🍴> (Food). The photo will look bright and appetizing. Also, depending on the light source, the reddish tinge will be suppressed in the pictures taken under tungsten lights, etc.

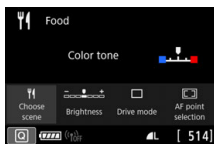

### Shooting Tips

- **Change the color tone.**  
You can change [**Color tone**]. To increase the food's reddish tinge, set it toward [**Warm**]. Set it toward [**Cool**] if it looks too red.



See the cautions on page 123.

## SCN: Shooting Candlelight Portraits

When you want to photograph a person in candlelight, use < > (Candlelight). The atmosphere of candlelight is reflected in the color tones of the picture.

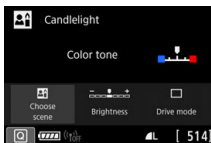

### Shooting Tips

- **Use the center AF point to focus.**

Aim the center AF point in the viewfinder on the subject, then shoot.

- **Prevent camera shake if the numeric display (shutter speed) in the viewfinder blinks.**

Under low light, the viewfinder's shutter speed display will blink.

Hold the camera steady or use a tripod. When using a zoom lens, you can reduce the blur caused by camera shake by setting the lens to the wide-angle end.

- **Change the color tone.**

You can change [Color tone]. To increase the candlelight's reddish tinge, set it toward [Warm]. Set it toward [Cool] if it looks too red.





- Live View shooting is not possible.
- See the cautions on page 123.

## SCN: Shooting Night Portraits (With a Tripod)

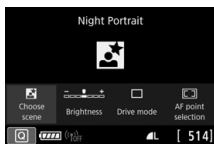
When you want to photograph people at night and obtain a natural-looking night scene in the background, use the  (Night Portrait) mode. **Note that an external Speedlite is required for shooting.** Using a tripod is recommended.



### Shooting Tips

- **Use a wide-angle lens and a tripod.**  
When using a zoom lens, use the wide-angle end to obtain a wide night view. Also, since camera shake is prone to occur with handheld shooting, use a tripod.
- **Check the subject's brightness.**  
Note that it is recommended to play back the captured image on location to check the image brightness. If the subject looks dark, move nearer and shoot again.
- **Also shoot in other shooting modes.**  
Since camera shake is prone to occur with night shots, shooting also with  and  is recommended.



See the cautions on page 124.



If you use the self-timer together with an external Speedlite, the self-timer lamp will light up briefly after the picture is taken.

## SCN: Shooting Night Scenes (Handheld)

Using a tripod when shooting a night scene gives the best results. However, the  (Handheld Night Scene) mode enables you to shoot night scenes even while handholding the camera. In this shooting mode, four shots are taken consecutively for each picture, and the resulting one image with reduced camera shake is recorded.

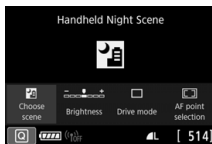

### Shooting Tips

- **Hold the camera firmly.**

During shooting, hold the camera firmly and steadily. In this mode, four shots are aligned and merged into a single image. However, if there is significant misalignment in any of the four shots due to camera shake, they may not align properly in the final image.

- **For portraits, use an external Speedlite.**

If you are to include people in the picture, use an external Speedlite. To take a nice portrait, the first shot will use flash. Tell the subject not to move until all four consecutive shots are taken.



See the cautions on page 124.

## SCN: Shooting Backlit Scenes

When shooting a scene having both the bright and dark areas, use the <  > (HDR Backlight Control) mode. When you take one picture in this mode, three consecutive shots are taken at different exposures. This results in one image, with a wide tonal range, that has minimized the clipped shadows caused by backlighting.

\* HDR stands for High Dynamic Range.

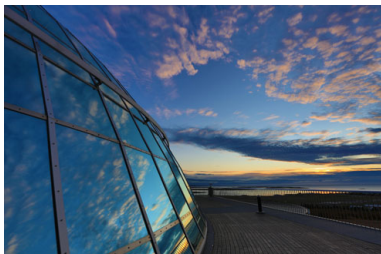
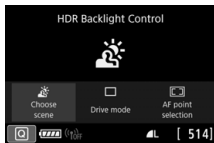

### Shooting Tips

- **Hold the camera firmly.**

During shooting, hold the camera firmly and steadily. In this mode, three shots are aligned and merged into a single image. However, if there is significant misalignment in any of the three shots due to camera shake, they may not align properly in the final image.



See the cautions on page 125.



## Cautions for the <SCN> Modes

### • <👤> Group Photo

- Since distortion correction is applied, the camera records an image area narrower than the one seen through the viewfinder. (The image periphery is slightly trimmed and the resolution looks slightly lowered.) Also, during Live View shooting, the angle of view changes slightly.
- Depending on the shooting conditions, focus may not be attained for everyone from the front to the back of the image.

### • <🏞️> Landscape

- If you are using an external Speedlite, the Speedlite will fire.

### • <🏃> Sports

- Under low light where camera shake tends to occur, the viewfinder's shutter speed display on the lower left will blink. Hold the camera steady and shoot.
- During Live View shooting, if the lens's focus mode switch is set to <AF>, you cannot select **M RAW** or **S RAW**.
- If you are using an external Speedlite, the Speedlite will fire.

### • <👶> Kids

- During Live View shooting, if the lens's focus mode switch is set to <AF>, you cannot select **M RAW** or **S RAW**.
- During Live View shooting, using an external Speedlite will decrease the continuous shooting speed. Note that even if the external Speedlite does not fire, the continuous shooting speed will still decrease.

### • <🏠> Panning

- The shutter speed will become slower. Therefore, this mode is not suitable for any shooting except for panning.
- By default, <🏠> is set. Note that <🏠H> or <🏠S> cannot be selected.
- For Live View shooting, you cannot select **M RAW** or **S RAW**.
- External Speedlites cannot be used. (It will not fire.)
- If you use Live View shooting with a lens supporting the <🏠> mode, the Image Stabilizer effect of the lens will be reflected to the captured images. However, you cannot see the effect in the Live View image during shooting. (The Image Stabilizer function and subject blur correction function are activated only at the moment the picture is taken, regardless of the lens's Image Stabilizer setting.)



### • <Panning> Panning (continued)

- If the lens does not support the <Panning> mode, subject blur will not be corrected. However, the automatic shutter speed adjustment alone will take effect according to the setting of [Effect].
- When shooting under bright light such as a sunny summer day or when shooting a slow subject, the set degree of panning effect may not be obtained.
- With Live View shooting and a lens supporting the <Panning> mode, subject blur may not be corrected properly when shooting the following subjects or under the following shooting conditions.
  - Subjects with very low contrast.
  - Subjects in low light.
  - Strongly backlit or reflective subjects.
  - Subjects with repetitive patterns.
  - Subjects with less patterns or monotonous patterns.
  - Subjects with reflections (images reflected in glass, etc.).
  - Subjects smaller than the Zone AF frame.
  - When there are multiple subjects moving within the Zone AF frame.
  - Subjects moving in irregular directions or at irregular speeds.
  - Subjects whose movements are partly irregular. (For example, the vertical movement of a runner.)
  - Subjects whose speed changes dramatically. (For example, right after the start of movement or while turning along a curve.)
  - When you move the camera too fast or too slow.
  - When the camera's movement does not match the subject's movement.

### • <Food> Food

- The warm color cast of subjects may fade.
- When multiple light sources are included in the scene, the warm color cast of the picture may not be reduced.
- If you use an external Speedlite, [Color tone] will be set to Standard.
- If there are people in the picture, the skin tone may not be reproduced properly.

### • <Candlelight> Candlelight

- External Speedlites cannot be used. (It will not fire.)
- If focus cannot be achieved with autofocus, use the EOS-dedicated Speedlite's AF-assist beam.



## • <Fn> Night Portrait

- Tell the subject to keep still even after the flash fires.
- During Live View shooting, achieving focus may be difficult when the face of the subject looks dark. In such a case, set the lens's focus mode switch to <MF> and focus manually.
- When you shoot a night scene with Live View shooting, achieving focus with AF may be difficult if point sources of light are found in the AF point. In such a case, set the lens's focus mode switch to <MF> and focus manually.
- The Live View image displayed will not look exactly the same as the actual captured image.

## • <Fn> Handheld Night Scene

- Compared to other shooting modes, the image area will be smaller.
- RAW image quality cannot be set.
- When you shoot a night scene with Live View shooting, achieving focus with AF may be difficult if point sources of light are found in the AF point. In such a case, set the lens's focus mode switch to <MF> and focus manually (p.154).
- The Live View image displayed will not look exactly the same as the actual captured image.
- If you use an external Speedlite and the subject is close, overexposure may result.
- If you use an external Speedlite for a night scene with limited lighting, the shots may not align correctly. This may result in a blurry picture.
- If you use an external Speedlite with a human subject close to the background that is also illuminated by the flash, the shots may not align correctly. This may result in a blurry picture. Unnatural shadows and unsuitable colors may also appear.
- Flash coverage angle with an external Speedlite:
  - When using a Speedlite with automatic flash coverage setting, the zoom position will be fixed to the wide (wide-angle) end regardless of the lens's zoom position.
  - When using a Speedlite requiring manual flash coverage setting, set the flash head to the normal position.





• **< [Night Scene Icon] > Handheld Night Scene** (continued)

- If you shoot a moving subject, the subject's movement may leave afterimages, or the surrounding area of the subject may become dark.
- The image alignment may not function properly with repetitive patterns (lattice, stripes, etc.), flat or single-tone images, or images significantly misaligned due to camera shake.
- It takes some time to record images to the card since they are merged after shooting. During the processing of the images, "buSY" will be displayed in the viewfinder and on the LCD panel, and you cannot take another picture until the processing is complete.

• **< [HDR Backlight Control Icon] > HDR Backlight Control**

- Compared to other shooting modes, the image area will be smaller.
- RAW image quality cannot be set.
- External Speedlites cannot be used. (It will not fire.)
- Note that the image may not be rendered with a smooth gradation and may look irregular or have significant noise.
- HDR Backlight Control may not be effective for excessively backlit scenes or extremely high-contrast scenes.
- When shooting subjects that are sufficiently bright as they are, for example for normally lit scenes, the image may look unnatural due to the HDR effect.
- If you shoot a moving subject, the subject's movement may leave afterimages, or the surrounding area of the subject may become dark.
- The image alignment may not function properly with repetitive patterns (lattice, stripes, etc.), flat or single-tone images, or images significantly misaligned due to camera shake.
- It takes some time to record images to the card since they are merged after shooting. During the image processing, "buSY" will be displayed in the viewfinder and on the LCD panel, and you cannot take another picture until the processing is complete.

## **Q** Quick Control

In Basic Zone modes, pressing the **<Q>** button sets the items shown in the tables on the next page with the Quick Control.

### **1** Set the Mode Dial to a Basic Zone mode.

Example: **<A+>** mode

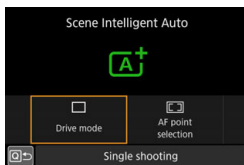



### **2** Press the **<Q>** button (10).

▶ The Quick Control screen will appear.

### **3** Set the desired function.

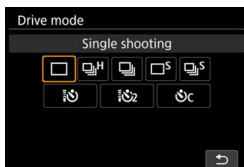

- Press the **<▲>** **<▼>** or **<◀>** **<▶>** keys to select a function.
- ▶ The settings of the selected function and Feature guide (p.90) will appear.
- Turn the **<⚙>** or **<⦿>** dial to change the setting.
- You can also select it from a list by selecting a function and pressing **<SET>**.









 You can also tap on the screen for Quick Control settings.

## Settable Functions in Basic Zone Modes

●: Default setting\*<sup>1</sup> ○: User selectable : Not selectable







Function			
Ambience-based shots (p.101)			<input type="checkbox"/>
Background blur (p.103)			<input type="checkbox"/>
Drive mode (p.156)	Single shooting	●	●
	High-speed continuous shooting	<input type="checkbox"/>	<input type="checkbox"/>
	Low-speed continuous shooting	<input type="checkbox"/>	<input type="checkbox"/>
	Silent single shooting* <sup>2</sup>	<input type="checkbox"/>	<input type="checkbox"/>
	Silent continuous shooting* <sup>2</sup>	<input type="checkbox"/>	<input type="checkbox"/>
	10-sec. self-timer/Remote control	<input type="checkbox"/>	<input type="checkbox"/>
	2-sec. self-timer/Remote control	<input type="checkbox"/>	<input type="checkbox"/>
Self-timer: Continuous shooting		<input type="checkbox"/>	<input type="checkbox"/>
AF point selection (p.136, 137)		<input type="checkbox"/>	<input type="checkbox"/>

Function		SCN					
							
Panning (p.114)							<input type="checkbox"/>
Brightness (p.106)		<input type="checkbox"/>	<input type="checkbox"/>	<input type="checkbox"/>	<input type="checkbox"/>	<input type="checkbox"/>	<input type="checkbox"/>
Drive mode (p.156)	Single shooting	<input type="checkbox"/>	●	●	<input type="checkbox"/>	<input type="checkbox"/>	<input type="checkbox"/>
	High-speed continuous shooting	<input type="checkbox"/>	<input type="checkbox"/>	<input type="checkbox"/>	●	●	
	Low-speed continuous shooting	●	<input type="checkbox"/>	<input type="checkbox"/>	<input type="checkbox"/>	<input type="checkbox"/>	●
	Silent single shooting* <sup>2</sup>	<input type="checkbox"/>	<input type="checkbox"/>	<input type="checkbox"/>	<input type="checkbox"/>	<input type="checkbox"/>	<input type="checkbox"/>
	Silent continuous shooting* <sup>2</sup>	<input type="checkbox"/>	<input type="checkbox"/>	<input type="checkbox"/>	<input type="checkbox"/>	<input type="checkbox"/>	
	10-sec. self-timer/Remote control	<input type="checkbox"/>	<input type="checkbox"/>	<input type="checkbox"/>	<input type="checkbox"/>	<input type="checkbox"/>	<input type="checkbox"/>
	2-sec. self-timer/Remote control	<input type="checkbox"/>	<input type="checkbox"/>	<input type="checkbox"/>	<input type="checkbox"/>	<input type="checkbox"/>	<input type="checkbox"/>
Self-timer: Continuous shooting		<input type="checkbox"/>	<input type="checkbox"/>	<input type="checkbox"/>	<input type="checkbox"/>	<input type="checkbox"/>	<input type="checkbox"/>
AF point selection (p.136, 137)		<input type="checkbox"/>	<input type="checkbox"/>	<input type="checkbox"/>	<input type="checkbox"/>	<input type="checkbox"/>	<input type="checkbox"/>

\*1: If you change the shooting mode or set the power switch to <OFF>, all the functions will revert to their default settings (except the self-timer).

\*2: Settable only with viewfinder shooting.

●: Default setting<sup>\*1</sup> ○: User selectable □: Not selectable

Function		SCN					
							
Color tone (p.106)			○	○			
Brightness (p.106)		○	○	○	○	○	
Drive mode (p.156)	Single shooting	●	●	●	●	●	●
	High-speed continuous shooting	○	○	○	○	○	○
	Low-speed continuous shooting	○	○	○	○	○	○
	Silent single shooting <sup>*2</sup>	○	○	○	○	○	○
	Silent continuous shooting <sup>*2</sup>	○	○	○	○	○	○
	10-sec. self-timer/Remote control	○	○	○	○	○	○
	2-sec. self-timer/Remote control	○	○	○	○	○	○
	Self-timer: Continuous shooting	○	○	○	○	○	○
AF point selection (p.136, 137)		○	○		○	○	○

\*1: If you change the shooting mode or set the power switch to <OFF>, all the functions will revert to their default settings (except the self-timer).

\*2: Settable only with viewfinder shooting.

## Adjusting Ambience-based shots, Background blur, Brightness, and Color tone

Using Live View shooting is recommended when setting [Ambience-based shots], [Background blur], [Brightness], or [Color tone].

For the operating procedures for Live View shooting, see “Using Effect Preview in Live View Shooting” on page 105 and see “<SCN> mode [Brightness] and [Color tone]” on page 106. You can adjust the effects while looking at the Live View image.

# 3

## Setting the AF and Drive Modes

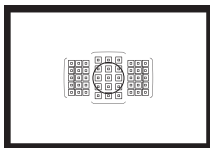

The AF points in the viewfinder are arranged to make AF shooting suitable for a wide variety of subjects and scenes.

You can also select the AF operation and drive mode that best match the shooting conditions and subject.

- The ☆ icon at the upper right of the page title indicates that the function is available only in Creative Zone modes (<P>, <Tv>, <Av>, <M>, <B>).
- In Basic Zone modes, the AF operation is set automatically.



<AF> stands for autofocus. <MF> stands for manual focus.

# AF: Selecting the AF Operation ☆

You can select the AF operation characteristics to suit the shooting conditions or subject. In Basic Zone modes, the optimum AF operation is set automatically for the respective shooting mode.

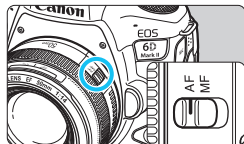

1 Set the lens's focus mode switch to <AF>.

2 Turn the Mode Dial to a Creative Zone mode.

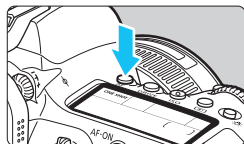

3 Press the <AF> button (⓪6).

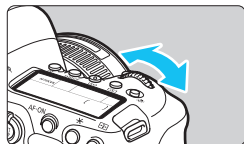

4 Select the AF operation.

- While looking at the LCD panel or the viewfinder, turn the <⚙> or <☀> dial.

**ONE SHOT** : One-Shot AF

**AI FOCUS** : AI Focus AF

**AI SERVO** : AI Servo AF

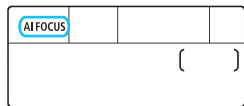

In Creative Zone modes, you can also press the <AF-ON> button to autofocus.

## One-Shot AF for Still Subjects



AF point

Focus indicator

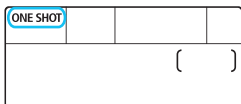

**Suited for still subjects. When you press the shutter button halfway, the camera will focus only once.**

- The AF point that achieves focus is displayed, and the focus indicator <●> in the viewfinder will also light up.
- With the camera in the default settings and the metering mode set to the evaluative metering (p.243), the exposure setting is set at the same time the focus is achieved.
- While you keep holding down the shutter button halfway, the focus will be locked. You can then recompose the shot if desired.



- If focus cannot be achieved, the focus indicator <●> in the viewfinder will blink. If this occurs, the picture cannot be taken even if the shutter button is pressed completely. Recompose the shot and try to focus again or see “When Autofocus Fails” (p.153).
- If [**4: Beep**] is set to [**Disable**], the beeper will not sound when focus is achieved.
- After achieving focus with One-Shot AF, you can lock the focus on a subject and recompose the shot. This is called “focus lock”. This is useful in cases such as when you want to focus on a peripheral subject not covered by the Area AF frame.
- With a lens equipped with electronic MF, setting [**1: Lens electronic MF**] to [**Enable after One-Shot AF**] will enable you to manually adjust the focus after achieving focus with AF (p.155).

## AI Servo AF for Moving Subjects

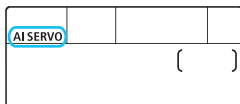

This AF operation is suited for moving subjects when the focusing distance keeps changing. While you hold down the shutter button halfway, the camera will keep focusing on the subject continuously.

- The exposure is set at the moment the picture is taken.
- When the AF area selection mode (p.139) is set to Automatic selection AF, focus tracking will continue as long as the Area AF frame covers the subject.

 With AI Servo AF, the beeper will not sound even when focus is achieved. Also, the focus indicator <●> in the viewfinder will not light up.

## AI Focus AF for Switching the AF Operation Automatically

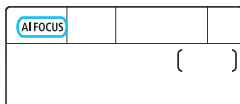

AI Focus AF switches the AF operation from One-Shot AF to AI Servo AF automatically if a still subject starts moving.

- After the subject is focused in One-Shot AF, if the subject starts moving, the camera will detect the movement, change the AF operation automatically to AI Servo AF, and start tracking the moving subject.

 When focus is achieved with AI Focus AF with the Servo operation active, the beeper will continue beeping softly. However, the focus indicator <●> in the viewfinder will not light up. Note that focus lock is not possible in this case.



## AF Points Lighting Up in Red

By default, the AF points light up in red when focus is achieved in low-light conditions or on a dark subject. In Creative Zone modes, you can set whether to have the AF points light up in red when focus is achieved (p.488).

## Selecting the AF Area and AF Point

The camera has 45 AF points for autofocus. You can select the AF area selection mode and AF point(s) suiting the scene or subject.

 Depending on the lens used, the number of usable AF points, AF point patterns, Area AF frame shape, etc. vary. For details, see “Lenses and Usable AF Points” on page 145.

### AF Area Selection Mode

You can select one of five AF area selection modes. For the selection procedure, see page 136.

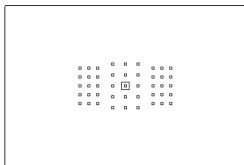

#### **Single-point Spot AF (Manual selection)**

For pinpoint focusing.

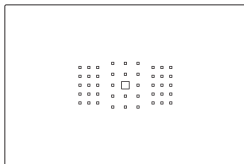

#### **Single-point AF (Manual selection)**

Select one AF point to focus.

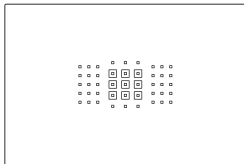

#### **Zone AF (Manual selection of zone)**

The AF area is divided into nine focusing zones for focusing.

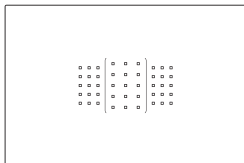

**[ ] Large Zone AF**  
**(Manual selection of zone)**

The AF area is divided into three focusing zones (left, center, and right) for focusing.

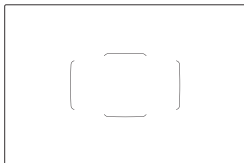



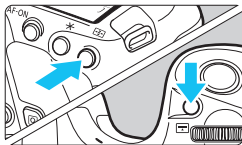

**[ ] Automatic selection AF**

The Area AF frame (entire AF area) is used to focus.

## Selecting the AF Area Selection Mode





**1** Press the  or  button (ⓘ6).

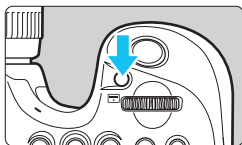





- Look through the viewfinder and press the  or  button.



**2** Press the  button.

- Each time you press the  button, the AF area selection mode changes.

- In the **<SCN: >** mode, you cannot select the AF area. Single-point AF (fixed at center) is applied for shooting.
- In Basic Zone modes, any of the following operations will revert the AF area and AF point settings to the default.
  - Changing the shooting mode.
  - Setting the power switch to **<OFF>**.
  - Opening the battery compartment cover or card slot cover.

- With [ **C.Fn II-8: Select AF area selec. mode**], you can limit the selectable AF area selection modes to only those you want to use (p.481).
- If you set [ **C.Fn II-9: AF area selection method**] to [**1:  → Main Dial**], you can select the AF area selection mode by pressing the  or  button, then turning the  dial (p.482).

## Selecting the AF Point Manually

You can manually select the AF point or zone.

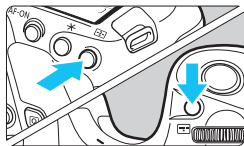

### 1 Press the or button ().

- ▶ The AF points will be displayed in the viewfinder.
- In the Zone AF mode or Large Zone AF mode, the selected zone will be displayed.

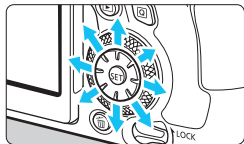

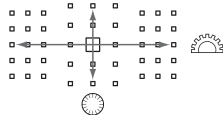

### 2 Select an AF point.

- The AF point selection will change in the direction you tilt . If you press , the center AF point (or center zone) will be selected.
- You can also select a horizontal AF point by turning the dial and select a vertical AF point by turning the dial.
- In the Zone AF and Large Zone AF modes, turning the or dial will change the zone (in a looping sequence for Zone AF).



- When you keep holding down the button and turn the dial, you can select an AF point in vertical direction.
- When [] is set to [Initial AF pt selected] (p.484), you can use this method to manually select the AI Servo AF's initial position.
- When you press the or button, the LCD panel displays the following:
  - Single-point Spot AF and Single-point AF: **SEL [ ]** (Center), **SEL AF** (Off center)
  - Zone AF, Large Zone AF, and Automatic selection AF: **[ ] AF**

## AF Point Display Indications

Pressing the  or  button lights up the AF points that are cross-type AF points for high-precision autofocusing. The blinking AF points are horizontal-line or vertical-line sensitive. For details, see pages 143-148.

# AF Area Selection Mode

## ☐ Single-point Spot AF (Manual selection)



For pinpoint focusing over a narrower area than with Single-point AF. Select one AF point <☐> to focus.

Effective for pinpoint focusing or focusing on overlapping subjects such as an animal in a cage. Since Single-point Spot AF covers a very small area, focusing may be difficult during handheld or low-light shooting or for a moving subject.

## ☐ Single-point AF (Manual selection)



Select one AF point <☐> to be used for focusing.

## ☐☐☐ Zone AF (Manual selection of zone)

The AF area is divided into nine focusing zones for focusing. Since all the AF points in the selected zone are used for Automatic selection AF, it is superior to Single-point AF in tracking the subject, and it is also effective for moving subjects.

However, since it is inclined to focus on the nearest subject, focusing on a specific target may be more difficult.

The AF point(s) achieving focus is displayed as <☐>.

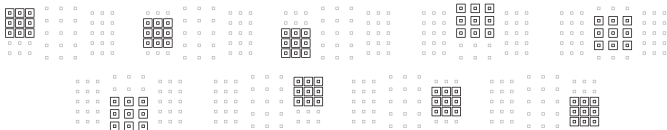

## ( ) Large Zone AF (Manual selection of zone)

The AF area is divided into three focusing zones (left, center, and right) for focusing. Since the focusing area is larger than with Zone AF and all the AF points in the selected zone are used for Automatic selection AF, it is superior to Single-point AF in tracking the subject, and it is effective for moving subjects.

However, since it is inclined to focus on the nearest subject, focusing on a specific target may be more difficult.

The AF point(s) achieving focus is displayed as <□>.



## ( ) Automatic selection AF

The Area AF frame (entire AF area) is used to focus. The AF point(s) achieving focus is displayed as <□>.



With One-Shot AF, pressing the shutter button halfway will display the AF point(s) <□> that achieved focus. If multiple AF points are displayed, it means they all have achieved focus. This mode tends to focus on the nearest subject.

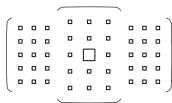

With AI Servo AF, you can set the AI Servo AF's initial position with [**..C.Fn II-11: Initial AF pt**, ( ) **AI Servo AF**] set to [1: Initial ( ) **AF pt selected**] or [2: Manual □ **AF pt**] (p.484). As long as the Area AF frame can track the subject during shooting, focusing will continue.











- When AI Servo AF mode is set for Zone AF, Large Zone AF, or Automatic selection AF, the active AF point <□> will keep switching to track the subject. However, under certain shooting conditions (such as when the subject is small), it may not be able to track the subject.
- With Single-point Spot AF, focusing with an EOS-dedicated, external Speedlite's AF-assist beam may be difficult.
- If a peripheral AF point or a wide-angle or telephoto lens is used, achieving focus may be difficult with an EOS-dedicated, external Speedlite's AF-assist beam. In such a case, use the center AF point or an AF point close to the center.
- When the AF point(s) light up, part or all of the viewfinder may light up in red. This is a characteristic of AF point display.
- In low temperatures, the AF point display may be difficult to see or have a slower tracking response due to the characteristics of AF point display device (using liquid crystal).



With [] **C.Fn II-10: Orientation linked AF point**, you can set the AF area selection mode + AF point or only the AF point separately for the horizontal and vertical orientations (p.483).

## AF Using Color Tracking

With the camera in its default state, if the AF area selection mode is set to Zone AF (Manual selection of zone), Large Zone AF (Manual selection of zone), or Auto selection AF, color tracking AF detecting colors comparable to human skin tones will be performed (except in <SCN:       > modes).

For details, see [ **C.Fn II-12: Auto AF pt sel.:Color Tracking**] on page 485.



## AF Sensor

The camera's AF sensor has 45 AF points. The illustration below shows the AF sensor pattern corresponding to each AF point. When using lenses with a maximum aperture of  $f/2.8$  or faster, high-precision AF is possible at the viewfinder center.

Depending on the lens used, the number of usable AF points, AF point patterns, Area AF frame shape, etc. vary. For details, see "Lenses and Usable AF Points" on page 145.

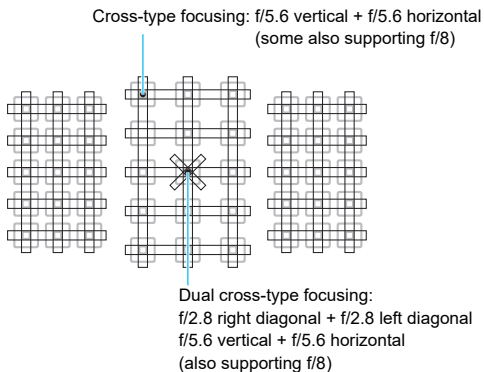
### Diagram

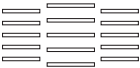

	<p>This focusing sensor is geared to obtain higher precision focusing for lenses with a maximum aperture of <math>f/2.8</math> or faster. A diagonal cross pattern makes it easier to focus on the subjects that may be difficult to focus. It is provided at the center AF point.</p>
	<p>These focusing sensors are geared for lenses with a maximum aperture of <math>f/5.6</math> or faster (and some supporting <math>f/8</math>). Since they have a horizontal pattern, they can detect vertical lines. They cover all 45 AF points.</p>
	<p>These focusing sensors are geared for lenses with a maximum aperture of <math>f/5.6</math> or faster (and some supporting <math>f/8</math>). Since they have a vertical pattern, they can detect horizontal lines. They cover all 45 AF points.</p>

# Lenses and Usable AF Points



- Although the camera has 45 AF points, **the number of usable AF points, focusing patterns, Area AF frame shape, etc. vary depending on the lens. The lenses are thereby classified into eight groups from A to H.**
- Using a lens in Groups E to H will have fewer usable AF points.
- **Lens groups are listed on pages 149-152.** Check which group your lens belongs to.



- When you press the or button, the AF points at the position indicated by the mark will blink. (The / AF points will stay lit.) Regarding lighting up or blinking of the AF points, see page 138.
- Regarding new lenses released after the EOS 6D Mark II (in the second half of 2017), check the Canon Web site to see which group they belong to.
- Some lenses may not be available in certain countries or regions.

## Group A

Autofocusing with 45 points is possible. All the AF area selection modes are selectable.



- : Dual cross-type AF point. Subject tracking performance is superior and the focusing precision is higher than with other AF points.
- : Cross-type AF point. Subject tracking performance is superior and high-precision focusing is achieved.

## Group B

Autofocusing with 45 points is possible. All the AF area selection modes are selectable.



- : Cross-type AF point. Subject tracking performance is superior and high-precision focusing is achieved.

## Group C

Autofocusing with 45 points is possible. All the AF area selection modes are selectable.



- : Cross-type AF point. Subject tracking performance is superior and high-precision focusing is achieved.
- : AF points sensitive to horizontal lines.

## Group D

Autofocusing with 45 points is possible. All the AF area selection modes are selectable.

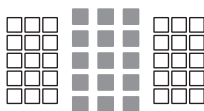

- : Cross-type AF point. Subject tracking performance is superior and high-precision focusing is achieved.
- : AF points sensitive to horizontal lines.

## Group E

Autofocusing with the 35 points is possible. (Not possible with all 45 AF points.) All the AF area selection modes are selectable. During automatic AF point selection, the outer frame marking the AF area (Area AF frame) will be different from 45-point Automatic selection AF.

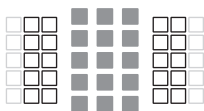

- : Cross-type AF point. Subject tracking performance is superior and high-precision focusing is achieved.
- : AF points sensitive to horizontal lines.
- : Disabled AF points (not displayed).

## Group F

Autofocusing with the 35 points is possible. (Not possible with all 45 AF points.) All the AF area selection modes are selectable. During automatic AF point selection, the outer frame marking the AF area (Area AF frame) will be different from 45-point Automatic selection AF.

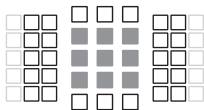

- : Cross-type AF point. Subject tracking performance is superior and high-precision focusing is achieved.
- : AF points sensitive to vertical lines (AF points in the horizontal array at the top and bottom) or horizontal lines (AF points in a vertical array on the left and right).
- : Disabled AF points (not displayed).

## Group G

Autofocusing with 27 points is possible. (Not possible with all 45 AF points.) Large Zone AF (manual selection of zone) cannot be selected in AF area selection mode. During automatic AF point selection, the outer frame marking the AF area (Area AF frame) will be different from 45-point Automatic selection AF.

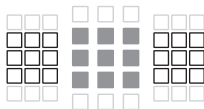

- : Cross-type AF point. Subject tracking performance is superior and high-precision focusing is achieved.
- : AF points sensitive to horizontal lines.
- : Disabled AF points (not displayed).

## Group H

Autofocusing is possible only with the center AF point.



- : Cross-type AF point. Subject tracking performance is superior and high-precision focusing is achieved.
- : Disabled AF points (not displayed).

- If the maximum aperture is slower than  $f/5.6$  (greater than  $f/5.6$  but not exceeding  $f/8$ ), focus may not be achieved with AF when shooting low-contrast or low-light subjects.
- If the maximum aperture is slower than  $f/8$  (greater than  $f/8$ ), AF is not possible during viewfinder shooting.



## Lens Group Designations

EF14mm f/2.8L USM	A	EF180mm f/3.5L Macro USM	B
EF14mm f/2.8 II USM	A	EF180mm f/3.5L Macro USM + Extender EF1.4x I/II/III	F
EF15mm f/2.8 Fisheye	A	EF200mm f/1.8L USM	A
EF20mm f/2.8 USM	A	EF200mm f/1.8L USM + Extender EF1.4x I/II/III	A*
EF24mm f/1.4L USM	A	EF200mm f/1.8L USM + Extender EF2x I/II/III	B*
EF24mm f/1.4L II USM	A	EF200mm f/2L IS USM	A
EF24mm f/2.8	A	EF200mm f/2L IS USM + Extender EF1.4x I/II/III	A
EF24mm f/2.8 IS USM	A	EF200mm f/2L IS USM + Extender EF2x I/II/III	B
EF28mm f/1.8 USM	A	EF200mm f/2.8L USM	A
EF28mm f/2.8	A	EF200mm f/2.8L USM + Extender EF1.4x I/II/III	B
EF28mm f/2.8 IS USM	A	EF200mm f/2.8L II USM	A
EF35mm f/1.4L USM	A	EF200mm f/2.8L II USM + Extender EF1.4x I/II/III	B
EF35mm f/1.4L II USM	A	EF200mm f/2.8L II USM + Extender EF2x I/II/III	B
EF35mm f/2	A	EF300mm f/2.8L USM	A
EF35mm f/2 IS USM	A	EF300mm f/2.8L USM + Extender EF1.4x I/II/III	B*
EF40mm f/2.8 STM	A	EF300mm f/2.8L USM + Extender EF2x I/II/III	B*
EF50mm f/1.0L USM	A	EF300mm f/2.8L IS USM	A
EF50mm f/1.2L USM	A	EF300mm f/2.8L IS USM + Extender EF1.4x I/II/III	B
EF50mm f/1.4 USM	A	EF300mm f/2.8L IS II USM	A
EF50mm f/1.8	A	EF300mm f/2.8L IS II USM + Extender EF1.4x I/II/III	B
EF50mm f/1.8 II	A	EF300mm f/4L USM	B
EF50mm f/1.8 STM	A	EF300mm f/4L USM + Extender EF1.4x I/II/III	B
EF50mm f/2.5 Compact Macro	B	EF300mm f/4L USM + Extender EF2x I/II/III	B
EF50mm f/2.5 Compact Macro + LIFE SIZE Converter	B	EF300mm f/4L USM + Extender EF1.4x I/II/III	B
EF85mm f/1.2L USM	A	EF300mm f/4L USM + Extender EF2x I/II/III	B
EF85mm f/1.2L II USM	A	EF300mm f/4L USM + Extender EF1.4x I/II/III	B
EF85mm f/1.8 USM	A	EF300mm f/4L USM + Extender EF2x I/II/III	B
EF100mm f/2 USM	A	EF300mm f/4L USM + Extender EF1.4x I/II/III	B
EF100mm f/2.8 Macro	B	EF300mm f/4L USM + Extender EF2x I/II/III	B
EF100mm f/2.8 Macro USM	E	EF300mm f/4L USM + Extender EF1.4x I/II/III	B
EF100mm f/2.8L Macro IS USM	B	EF300mm f/4L USM + Extender EF2x I/II/III	B
EF135mm f/2L USM	A	EF300mm f/4L USM + Extender EF1.4x I/II/III	B
EF135mm f/2L USM + Extender EF1.4x I/II/III	A	EF300mm f/4L USM + Extender EF2x I/II/III	B
EF135mm f/2L USM + Extender EF2x I/II/III	B	EF300mm f/4L USM + Extender EF1.4x I/II/III	B
EF135mm f/2L USM	B	EF300mm f/4L USM + Extender EF2x I/II/III	H (f/8)
EF135mm f/2.8 (Softfocus)	A		

## Lenses and Usable AF Points

EF300mm f/4L IS USM	B	EF500mm f/4L IS II USM	
EF300mm f/4L IS USM + Extender EF1.4x I/II/III	B	+ Extender EF2x I/II/III	H (f/8)
EF300mm f/4L IS USM + Extender EF2x I/II/III	H (f/8)	EF500mm f/4.5L USM	B
EF400mm f/2.8L USM	A	EF500mm f/4.5L USM + Extender EF1.4x I/II/III	H (f/8)*
EF400mm f/2.8L USM + Extender EF1.4x I/II/III	B*	EF600mm f/4L USM	B
EF400mm f/2.8L USM + Extender EF2x I/II/III	B*	EF600mm f/4L USM + Extender EF1.4x I/II/III	B*
EF400mm f/2.8L II USM	A	EF600mm f/4L USM + Extender EF2x I/II/III	H (f/8)*
EF400mm f/2.8L II USM + Extender EF1.4x I/II/III	B*	EF600mm f/4L IS USM	B
EF400mm f/2.8L II USM + Extender EF2x I/II/III	B*	EF600mm f/4L IS USM + Extender EF2x I/II/III	H (f/8)
EF400mm f/2.8L IS USM	A	EF600mm f/4L IS II USM	B
EF400mm f/2.8L IS USM + Extender EF1.4x I/II/III	B	EF600mm f/4L IS II USM + Extender EF1.4x I/II/III	B
EF400mm f/2.8L IS USM + Extender EF2x I/II/III	B	EF600mm f/4L IS II USM + Extender EF2x I/II/III	H (f/8)
EF400mm f/2.8L IS II USM	A	EF800mm f/5.6L IS USM	E
EF400mm f/2.8L IS II USM + Extender EF1.4x I/II/III	B	EF800mm f/5.6L IS USM + Extender EF1.4x I/II/III	H (f/8)
EF400mm f/2.8L IS II USM + Extender EF2x I/II/III	B	EF1200mm f/5.6L USM	E
EF400mm f/4 DO IS USM	B	EF1200mm f/5.6L USM + Extender EF1.4x I/II/III	H (f/8)*
EF400mm f/4 DO IS USM + Extender EF1.4x I/II/III	B	EF8-15mm f/4L Fisheye USM	B
EF400mm f/4 DO IS USM + Extender EF2x I/II/III	H (f/8)	EF11-24mm f/4L USM	C
EF400mm f/4 DO IS II USM	B	EF16-35mm f/2.8L USM	A
EF400mm f/4 DO IS II USM + Extender EF1.4x I/II/III	B	EF16-35mm f/2.8L II USM	A
EF400mm f/4 DO IS II USM + Extender EF2x I/II/III	H (f/8)	EF16-35mm f/2.8L III USM	A
EF400mm f/5.6L USM	B	EF16-35mm f/4L IS USM	B
EF400mm f/5.6L USM + Extender EF1.4x I/II/III	H (f/8)	EF17-35mm f/2.8L USM	A
EF500mm f/4L IS USM	B	EF17-40mm f/4L USM	B
EF500mm f/4L IS USM + Extender EF1.4x I/II/III	B	EF20-35mm f/2.8L	A
EF500mm f/4L IS USM + Extender EF2x I/II/III	H (f/8)	EF20-35mm f/3.5-4.5 USM	C
EF500mm f/4L IS II USM	B	EF22-55mm f/4-5.6 USM	F
EF500mm f/4L IS II USM + Extender EF1.4x I/II/III	B	EF24-70mm f/2.8L USM	A
EF500mm f/4L IS II USM + Extender EF2x I/II/III	H (f/8)	EF24-70mm f/2.8L II USM	A
EF500mm f/4L IS II USM	B	EF24-70mm f/4L IS USM	B
EF500mm f/4L IS II USM + Extender EF1.4x I/II/III	B	EF24-85mm f/3.5-4.5 USM	D
EF500mm f/4L IS II USM + Extender EF2x I/II/III	B	EF24-105mm f/3.5-5.6 IS STM	B
		EF24-105mm f/4L IS USM	B
		EF24-105mm f/4L IS II USM	B

EF28-70mm f/2.8L USM	A	EF55-200mm f/4.5-5.6 II USM	D
EF28-70mm f/3.5-4.5	E	EF70-200mm f/2.8L USM	A
EF28-70mm f/3.5-4.5 II	E	EF70-200mm f/2.8L USM + Extender EF1.4x I/II/III	B**
EF28-80mm f/2.8-4L USM	B	EF70-200mm f/2.8L USM + Extender EF2x I/II/III	B**
EF28-80mm f/3.5-5.6	E	EF70-200mm f/2.8L IS USM	A
EF28-80mm f/3.5-5.6 USM	E	EF70-200mm f/2.8L IS USM + Extender EF1.4x I/II/III	B
EF28-80mm f/3.5-5.6 II	E	EF70-200mm f/2.8L IS USM + Extender EF2x I/II/III	B
EF28-80mm f/3.5-5.6 II USM	E	EF70-200mm f/2.8L IS II USM	A
EF28-80mm f/3.5-5.6 III USM	E	EF70-200mm f/2.8L IS II USM + Extender EF1.4x I/II/III	B
EF28-80mm f/3.5-5.6 IV USM	E	EF70-200mm f/2.8L IS II USM	A
EF28-80mm f/3.5-5.6 V USM	E	EF70-200mm f/2.8L IS II USM + Extender EF1.4x I/II/III	B
EF28-90mm f/4-5.6	B	EF70-200mm f/2.8L IS II USM + Extender EF2x I/II/III	B
EF28-90mm f/4-5.6 USM	B	EF70-200mm f/4L USM	B
EF28-90mm f/4-5.6 II	B	EF70-200mm f/4L USM + Extender EF1.4x I/II/III	B
EF28-90mm f/4-5.6 II USM	B	EF70-200mm f/4L USM + Extender EF2x I/II/III	H (f/8)
EF28-90mm f/4-5.6 III	B	EF70-200mm f/4L IS USM	B
EF28-105mm f/3.5-4.5 USM	B	EF70-200mm f/4L IS USM + Extender EF1.4x I/II/III	B
EF28-105mm f/3.5-4.5 II USM	B	EF70-200mm f/4L IS USM + Extender EF2x I/II/III	H (f/8)
EF28-105mm f/4-5.6	F	EF70-210mm f/3.5-4.5 USM	B
EF28-105mm f/4-5.6 USM	F	EF70-210mm f/4	B
EF28-135mm f/3.5-5.6 IS USM	B	EF70-300mm f/4-5.6 IS USM	B
EF28-200mm f/3.5-5.6	B	EF70-300mm f/4-5.6 IS II USM	B
EF28-200mm f/3.5-5.6 USM	B	EF70-300mm f/4-5.6L IS USM	B
EF28-300mm f/3.5-5.6L IS USM	B	EF70-300mm f/4.5-5.6 DO IS USM	B
EF35-70mm f/3.5-4.5	E	EF75-300mm f/4-5.6	B
EF35-70mm f/3.5-4.5A	E	EF75-300mm f/4-5.6 USM	C
EF35-80mm f/4-5.6	F	EF75-300mm f/4-5.6 II	B
EF35-80mm f/4-5.6 PZ	E	EF75-300mm f/4-5.6 II USM	B
EF35-80mm f/4-5.6 USM	F	EF75-300mm f/4-5.6 III	B
EF35-80mm f/4-5.6 II	E	EF75-300mm f/4-5.6 III USM	B
EF35-80mm f/4-5.6 III	F	EF75-300mm f/4-5.6 IS USM	B
EF35-105mm f/3.5-4.5	B	EF80-200mm f/2.8L	A
EF35-105mm f/4.5-5.6	H	EF80-200mm f/4.5-5.6	D
EF35-105mm f/4.5-5.6 USM	H	EF80-200mm f/4.5-5.6 USM	E
EF35-135mm f/3.5-4.5	B	EF80-200mm f/4.5-5.6 II	E
EF35-135mm f/4-5.6 USM	C	EF90-300mm f/4.5-5.6	D
EF35-350mm f/3.5-5.6L USM	D		
EF38-76mm f/4.5-5.6	E		
EF50-200mm f/3.5-4.5	B		
EF50-200mm f/3.5-4.5L	B		
EF55-200mm f/4.5-5.6 USM	D		

EF90-300mm f/4.5-5.6 USM	D	EF200-400mm f/4L IS USM	
EF100-200mm f/4.5A	B	Extender 1.4x: With built-in Ext. 1.4x	B
EF100-300mm f/4.5-5.6 USM	C	EF200-400mm f/4L IS USM	
EF100-300mm f/5.6	B	Extender 1.4x + Extender EF1.4x I/II/III	B
EF100-300mm f/5.6L	B	EF200-400mm f/4L IS USM	
EF100-400mm f/4.5-5.6L IS USM	B	Extender 1.4x: With built-in Ext. 1.4x + Extender EF1.4x I/II/III	H (f/8)
EF100-400mm f/4.5-5.6L IS USM + Extender EF1.4x I/II/III	H (f/8)	EF200-400mm f/4L IS USM	
EF100-400mm f/4.5-5.6L IS II USM	B	Extender 1.4x + Extender EF2x I/II	H (f/8)
EF100-400mm f/4.5-5.6L IS II USM + Extender EF1.4x I/II	H (f/8)	EF200-400mm f/4L IS USM	
EF100-400mm f/4.5-5.6L IS II USM + Extender EF1.4x III	G (f/8)	Extender 1.4x + Extender EF2x III	G (f/8)
EF200-400mm f/4L IS USM		TS-E17mm f/4L	B
Extender 1.4x	B	TS-E24mm f/3.5L	B
		TS-E24mm f/3.5L II	B
		TS-E45mm f/2.8	A
		TS-E90mm f/2.8	A



- If Extender EF2x (I/II/III) is attached to the EF180mm f/3.5L Macro USM lens, AF is not possible.
- When using a lens and Extender EF1.4x III/EF2x III in a combination marked with an asterisk “\*” or a lens and extender in a combination marked with two asterisks “\*\*”, precise focus may not be achieved with AF. In such a case, refer to the Instruction Manual of the lens or extender used.



If you use a TS-E lens, manual focusing will be required. The lens group designation of TS-E lenses applies only when you do not use the tilt or shift function.

## When Autofocus Fails

Autofocus may fail to achieve focus (focus indicator <●> in the viewfinder blinks) with special subjects such as the following:

### Subjects Difficult to Focus on

- Subjects with very low contrast  
(Example: Blue skies, solid-color flat surfaces, etc.)
- Subjects in very low light
- Strongly backlit or reflective subjects  
(Example: Cars with highly reflective bodies, etc.)
- Near and distant subjects positioned close to an AF point  
(Example: Animals in cages, etc.)
- Light source such as dots of light positioned close to an AF point  
(Example: Night scenes, etc.)
- Subjects with repetitive patterns  
(Example: Skyscraper windows, computer keyboards, etc.)
- Subjects with finer patterns than an AF point  
(Example: Faces or flowers as small as or smaller than an AF point, etc.)

In such cases, focus in either of the following two ways.

- (1) With One-Shot AF, focus on an object at the same distance as the subject and lock the focus, then recompose the shot (p.131).
- (2) Set the lens's focus mode switch to <MF> and focus manually (p.154).



- Depending on the subject, focus may be achieved by slightly recomposing the shot and performing AF operation again.
- For conditions that make focusing difficult with AF during Live View shooting or movie shooting, see page 316.

## MF: Manual Focus

If focus cannot be achieved with autofocus, follow the procedure below to focus manually.

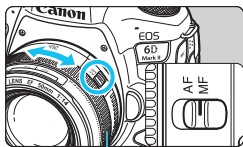

Focusing ring

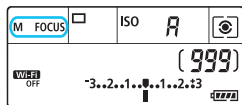

**1 Set the lens's focus mode switch to <MF>.**

- ▶ <M FOCUS> will be displayed on the LCD panel.

**2 Focus on the subject.**

- Turn the lens focusing ring until the subject looks sharp in the viewfinder.

- If you press the shutter button halfway during manual focusing, the AF point that achieved focus will be displayed, and the focus indicator <●> will light up in the viewfinder.
- With Automatic selection AF, when the center AF point achieves focus, the focus indicator <●> will light up.

## MENU Setting Lens Electronic MF <sup>☆</sup>

With the following USM and STM lenses equipped with electronic manual focusing, you can set whether to use electronic manual focusing after autofocusing in One-Shot AF mode.

The default setting is [**Disable after One-Shot AF**].

EF50mm f/1.0L USM	EF300mm f/2.8L USM	EF600mm f/4L USM
EF85mm f/1.2L USM	EF400mm f/2.8L USM	EF1200mm f/5.6L USM
EF85mm f/1.2L II USM	EF400mm f/2.8L II USM	EF28-80mm f/2.8-4L USM
EF200mm f/1.8L USM	EF500mm f/4.5L USM	EF70-300mm f/4-5.6 IS II USM
EF40mm f/2.8 STM	EF50mm f/1.8 STM	EF24-105mm f/3.5-5.6 IS STM

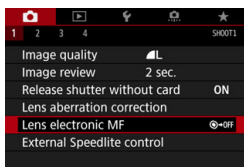

### 1 Select [**Lens electronic MF**].

- Under the [**1**] tab, select [**Lens electronic MF**], then press <SET>.



### 2 Set the desired setting.

- Select the option to be set, then press <SET>.

- OFF**: **Disable after One-Shot AF**

Manual focus adjustment after the AF operation is disabled.

- ON**: **Enable after One-Shot AF**

You can manually adjust the focus after the AF operation if you keep holding down the shutter button halfway.

## Selecting the Drive Mode

Single and continuous drive modes are provided. You can select the drive mode suiting the scene or subject.

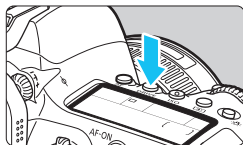

**1** Press the <DRIVE> button ()6).

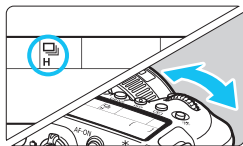

**2** Select the drive mode.

- While looking at the LCD panel or in the viewfinder, turn the < > dial.

### : Single shooting

When you press the shutter button completely, only one shot will be taken.

### H : High-speed continuous shooting

When you hold down the shutter button completely, you can shoot continuously at **max. approx. 6.5 shots/sec.** while you keep holding it down.

However, the maximum continuous shooting speed may become slower under the following conditions:

#### • With Anti-flicker shooting:

The continuous shooting speed will be **max. approx. 5.6 shots/sec.**

#### • With Live View shooting:

When [AF operation] is set to [One-Shot AF], or when [Manual Focus] is set, the continuous shooting speed will be **max. approx. 6.5 shots/sec.**

When [AF operation] is set to [Servo AF], the continuous shooting speed of **max. approx. 4.0 shots/sec.** will be given priority.

Note that if an EX-series Speedlite is used with Live View shooting, the continuous shooting speed will be **max. approx. 1.7 shots/sec.**



 : **Low-speed continuous shooting**

While you hold down the shutter button completely, you can shoot continuously at **max. approx. 3.0 shots/sec.** (except the < > mode).

Note that during Live View shooting, if [AF operation] is set to [Servo AF], subject tracking is given priority (Subject-tracking priority) at a continuous shooting speed of **max. approx. 3.0 shots/sec.** (except the < > mode).

 S : **Silent single shooting**

You can perform single shooting while suppressing the mechanical sound during viewfinder shooting. This cannot be set for Live View shooting.

 S : **Silent continuous shooting**

During viewfinder shooting, you can shoot continuously at **max. approx. 3.0 shots/sec.** while suppressing the mechanical sound (compared to the < > setting). This cannot be set for Live View shooting.



 : **10-sec. self-timer/remote control**



 2 : **2-sec. self-timer/remote control**

 C : **Self-timer: Continuous**

For self-timer shooting, see page 159. For remote control shooting, see page 271.



- During < H > high-speed continuous shooting, the maximum continuous shooting speed varies depending on the shooting conditions. For details, see the next page.
- The continuous shooting speed in the < > Panning mode is described on page 115.

- The approx. 6.5 shots/sec. maximum high-speed continuous shooting speed <img alt="High-Speed Continuous Shooting icon" data-bbox="215 125 245 145"/> (p.156) is achieved under the following conditions: Fully charged battery pack, 1/500 sec. or faster shutter speed, maximum aperture (varies depending on the lens), at room temperature (23°C / 73°F), flicker reduction disabled, and Live View shooting with One-Shot AF\*.
  - \* With the AF mode set to One-Shot AF and the Image Stabilizer turned off when using the following lenses: EF300mm f/4L IS USM, EF28-135mm f/3.5-5.6 IS USM, EF75-300mm f/4-5.6 IS USM, EF100-400mm f/4.5-5.6L IS USM.
- The continuous shooting speed for <img alt="High-Speed Continuous Shooting icon" data-bbox="215 295 245 315"/> high-speed continuous shooting may decrease depending on the temperature, battery level, flicker reduction, shutter speed, aperture, subject conditions, brightness, AF operation, lens, Live View shooting, flash use, shooting function settings, etc.
- With [ 4: Anti-flicker shoot.] set to [Enable] (p.206), shooting under flickering light will decrease the maximum continuous shooting speed. Also, the continuous shooting interval may become irregular and the release time lag may become longer.
- For Live View shooting, if [AF operation] is set to [Servo AF] (p.305), the maximum continuous shooting speed will decrease.
- With AI Servo AF, the maximum continuous shooting speed may become slower depending on the subject conditions and the lens used.
- Using an EX-series Speedlite will decrease the maximum continuous shooting speed.
- If the battery temperature is low due to a low ambient temperature, the maximum continuous shooting speed may decrease.
- If <img alt="S icon" data-bbox="215 655 245 675"/> or <img alt="S icon" data-bbox="215 685 245 705"/> is set, the time lag from when you press the shutter button completely until the shutter is released will be longer than normal.
- When internal memory becomes full during continuous shooting, the continuous shooting speed may drop off because shooting will be temporarily disabled (p.167).
- Under [ 1: Wireless communication settings], if [Bluetooth function] is set to [Smartphone], remote control shooting is not possible. (The remote controller icon <img alt="Remote controller icon" data-bbox="215 805 245 825"/> is not displayed.)

## 🕒 Using the Self-timer

Use the self-timer when you want to be in the picture such as a commemorative photograph.

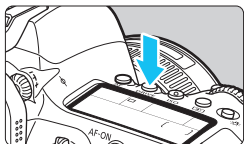

1 Press the <DRIVE> button (📷).

2 Select the self-timer.

- While looking at the LCD panel or in the viewfinder, turn the <🕒> dial.



🕒 : **Shoot in 10 sec.**

The picture is taken approx. 10 sec. after you press the shutter button completely. Remote control shooting is also possible (p.271).

🕒<sub>2</sub> : **Shoot in 2 sec.**

The picture is taken approx. 2 sec. after you press the shutter button completely. Remote control shooting is also possible.

🕒<sub>C</sub> : **10-sec. self-timer plus consecutive shots**

Turn the <🕒> dial to set the number of multiple shots (2 to 10) to be taken with the self-timer. The picture is taken in 10 sec. after you press the shutter button completely. Remote control shooting (p.271) is not possible.

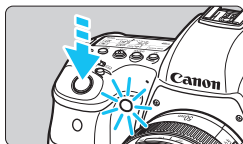

3 Take the picture.

- Look through the viewfinder, focus on the subject, then press the shutter button completely.
- ▶ You can check the self-timer operation with the self-timer lamp, beeper, and countdown display (in seconds) on the LCD panel.
- ▶ Approx. 2 sec. before the picture is taken, the self-timer lamp will light up and the beeper will sound faster.

- If you do not look through the viewfinder when you press the shutter button, attach the eyepiece cover (p.270). If stray light enters the viewfinder when the picture is taken, it may throw off the exposure.
  - With <ⓈC>, the interval between multiple shots may be prolonged depending on shooting conditions such as the image-recording quality and external flash use.
- 
- <Ⓢ2> enables you to shoot without touching the camera mounted on a tripod. This prevents camera shake if you shoot still lifes or long exposures.
  - After taking self-timer shots, playing back the image (p.388) to check focus and exposure is recommended.
  - When using the self-timer to shoot yourself, use focus lock (p.97) on an object at the same distance as where you will stand.
  - To cancel the self-timer after it starts, either tap on the LCD monitor or press the <DRIVE> button.
  - If remote control shooting is enabled, it will take approx. 2 min. for auto power off to take effect even if [**2: Auto power off**] is set to [1 min.].
  - If [**4: Bulb timer**] is set to [Enable], <ⓈC> ([Self-timer: Continuous]) cannot be selected.

# 4

## Image Settings

This chapter describes image-related functions: Image-recording quality, aspect ratio, ISO speed, Picture Style, white balance, Auto Lighting Optimizer, noise reduction, highlight tone priority, lens aberration correction, anti-flicker shooting, and other functions.

- The ☆ icon at the upper right of the page title indicates that the function is available only in Creative Zone modes (<P>, <Tv>, <Av>, <M>, <B>).

## MENU Setting the Image-Recording Quality

You can select the pixel count and the image quality. Seven JPEG quality settings are provided: **L**, **L**, **M**, **M**, **S1**, **S1**, and **S2**. Three RAW image-recording quality settings are provided: **RAW**, **M RAW**, and **S RAW** (p.166).

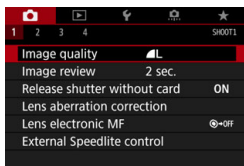

### 1 Select [Image quality].

- Under the [**1**] tab, select [**Image quality**], then press **<SET>**.



### 2 Set the image-recording quality.

- To select a RAW setting, turn the **<WHEEL>** dial. To select a JPEG setting, press the **<◀>** or **<▶>** keys.
- On the upper right, the "**\*\*M** (megapixels) **\*\*\*\*x\*\*\*\***" number indicates the recorded pixel count, and **[\*\*]** is the number of possible shots (displayed up to 9999).
- Press **<SET>** to set it.

**!** The image size **[\*\*\*\*x\*\*\*\*]** and number of possible shots **[\*\*\*\*]** displayed on the image-recording quality setting screen always apply to the **[3:2]** setting regardless of the **[4: Aspect ratio]** setting (p.168).

**!** If **[-]** is set for both the RAW image and JPEG image, **L** will be set.

## Image-recording Quality Setting Examples

**L** only

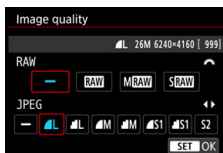

**RAW** only

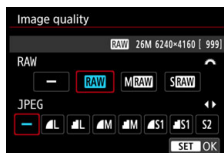

**RAW** + **L**

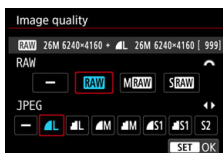

**S RAW** + **M**

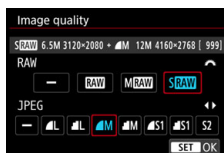

## Guide to Image-Recording Quality Settings

(Approx.)



Image Quality	Pixels Recorded	Print Size	File Size (MB)	Possible Shots	Maximum Burst	
					Standard	High Speed
<b>JPEG</b>						
L	26M	A2	7.5	1000	110	150
L			3.8	1950	150	150
M	12M	A3	4.0	1870	150	150
M			2.1	3570	150	150
S1	6.5M	A4	2.6	2820	150	150
S1			1.4	5310	150	150
S2	3.8M	A5	1.8	4170	150	150
<b>RAW</b>						
RAW	26M	A2	32.6	200	18	21
M RAW	15M	A3	25.3	250	21	23
S RAW	6.5M	A4	17.4	340	25	25
<b>RAW+JPEG</b>						
RAW L	26M 26M	A2 A2	32.6 + 7.5	160	17	19
M RAW L	15M 26M	A3 A2	25.3 + 7.5	200	18	18
S RAW L	6.5M 26M	A4 A2	17.4 + 7.5	250	19	19

S2 is in (Fine) quality.



- The number of possible shots is based on Canon's testing standards and an 8 GB card.
- The maximum burst during continuous shooting is based on Canon's standard testing SD card (Standard: 8 GB, High-speed: UHS-I 16 GB) and testing standards (<img alt="High-speed continuous shooting icon" data-bbox="125 178 145 198"/> High-speed continuous shooting, 3:2 aspect ratio, ISO 100, Standard Picture Style).
- **The file size, number of possible shots, and maximum burst will vary depending on the subject, card brand, aspect ratio, ISO speed, Picture Style, Custom Functions, and other settings.**



- Even if you use a high-speed SD card, maximum burst indicator will not change. The maximum burst in the table on the preceding page will apply instead.
- If you select both RAW and JPEG, each time you shoot, the image will be recorded simultaneously to the card in both RAW and JPEG at the image-recording qualities that were set. The two images will be recorded with the same file numbers (file extension: .JPG for JPEG and .CR2 for RAW).
- The image-recording quality icons indicate as follows: **RAW** (RAW), **M RAW** (Medium RAW), **S RAW** (Small RAW), JPEG (JPEG),  (Fine),  (Normal), **L** (Large), **M** (Medium), **S** (Small).

## RAW Images

A RAW image is raw data output by the image sensor converted to digital data. It is recorded to the card as is, and you can select the quality as follows: **RAW**, **M RAW**, or **S RAW**.

A **RAW** image can be processed with [▶] **1: RAW image processing** (p.438) and saved as a JPEG image. (**M RAW** and **S RAW** images cannot be processed with the camera.) As the RAW image itself does not change, you can process the RAW image to create any number of JPEG images with various processing conditions.

You can use Digital Photo Professional (EOS software, p.594) to process RAW images. You can make various adjustments to images depending upon how they will be used and can generate JPEG, TIFF, or other types of images reflecting the effects of those adjustments.



### RAW Image Processing Software

- To display RAW images on a computer, using Digital Photo Professional (hereafter DPP, EOS software) is recommended.
- Previous versions of DPP Ver.4.x cannot process RAW images taken with this camera. If a previous version of DPP Ver.4.x is installed on your computer, obtain and install the latest version of DPP from the Canon Web site to update it (p.596). (The previous version will be overwritten.) Note that DPP Ver.3.x or earlier cannot process RAW images taken with this camera.
- Commercially-available software may not be able to display RAW images taken with this camera. For compatibility information, contact the software manufacturer.

## Maximum Burst for Continuous Shooting



The approximate maximum burst is displayed at the bottom right of the viewfinder and Quick Control screen. If the maximum burst for continuous shooting is 99 or higher, “99” will be displayed.

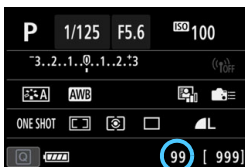

The maximum burst is displayed even when a card is not inserted in the camera. Make sure that a card is inserted before taking a picture.



If the maximum burst is displayed as “99”, it indicates that you can shoot 99 or more shots continuously. If the maximum burst decreases to 98 or lower and the internal buffer memory becomes full, “buSY” will be displayed in the viewfinder and on the LCD panel. Shooting will then be disabled temporarily. If you stop continuous shooting, the maximum burst will increase. After all the captured images are written to the card, you can resume continuous shooting and shoot up to the maximum burst listed in the table on page 164.

## MENU Setting the Aspect Ratio ☆

You can change the image's aspect ratio. [3:2] is set by default. When [4:3], [16:9], or [1:1] is set, frame lines indicating the image area will be displayed in the viewfinder. During Live View shooting, the image appears with the surrounding area masked in black on the LCD monitor.

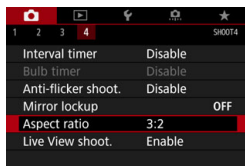

### 1 Select the aspect ratio.

- Under the [CAMERA] tab, select [Aspect ratio], then press <SET>.

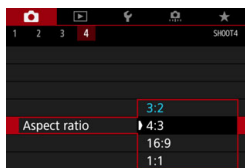

### 2 Set the aspect ratio.

- Select an aspect ratio, then press <SET>.

#### • JPEG images

The images will be recorded with the set aspect ratio.

#### • RAW images

The images will always be recorded in the [3:2] aspect ratio. The selected aspect ratio information is added to the RAW image file.

When you process the RAW image with Digital Photo Professional (EOS software), this allows you to generate an image with the same aspect ratio set for shooting.







	Aspect Ratio		
	4:3	16:9	1:1
With viewfinder shooting			
With Live View shooting			

Image Quality	Aspect Ratio and Pixel Count (Approx.)			
	3:2	4:3	16:9	1:1
L	6240x4160 (26.0 megapixels)	5536x4160* (23.0 megapixels)	6240x3504* (21.9 megapixels)	4160x4160 (17.3 megapixels)
M	4160x2768* (11.5 megapixels)	3680x2768* (10.2 megapixels)	4160x2336* (9.7 megapixels)	2768x2768 (7.7 megapixels)
S1	3120x2080 (6.5 megapixels)	2768x2080* (5.8 megapixels)	3120x1752* (5.5 megapixels)	2080x2080 (4.3 megapixels)
S2	2400x1600 (3.8 megapixels)	2112x1600* (3.4 megapixels)	2400x1344* (3.2 megapixels)	1600x1600 (2.6 megapixels)



- The actual aspect ratio of images in the sizes marked with an asterisk "\*" will differ from the aspect ratio indicated.
- The image area displayed for the asterisked "\*" aspect ratio may be slightly different from the actual image area. Check the captured images on the LCD monitor during shooting.
- The picture will be taken at the [3:2] aspect ratio setting for the multiple-exposures.



When you play back RAW images shot in the [4:3], [16:9], or [1:1] aspect ratio, they will be displayed with lines indicating the respective aspect ratio. (These lines are not recorded in the image.)

# ISO: Setting the ISO Speed for Still Photos ☆

Set the ISO speed (image sensor's sensitivity to light) to suit the ambient light level. In Basic Zone modes, the ISO speed is set automatically (p.172).

Regarding the ISO speed during movie shooting, see pages 327 and 331.



**1** Press the <ISO> button (⚙️6).

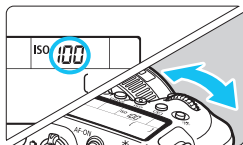

**2** Set the ISO speed.

- While looking at the LCD panel or the viewfinder, turn the <⚙️> or <⌚> dial.
- ISO speed can be set within ISO 100 - ISO 40000 in 1/3-stop increments.
- “A” indicates ISO Auto. The ISO speed will be set automatically (p.172).

## ISO Speed Guide

ISO Speed	Shooting Situation (No flash)	Flash Range
L (50), ISO 100 - ISO 400	Sunny outdoors	The higher the ISO speed, the farther the effective flash range will be.
ISO 400 - ISO 1600	Overcast skies or evening time	
ISO 1600 - ISO 40000, H1 (51200), H2 (102400)	Dark indoors or night	

\* High ISO speeds will result in grainier images.

 You can also set the ISO speed with the [CAMERA: ISO speed settings] menu's [ISO speed] screen.



- As H1 (equivalent to ISO 51200) and H2 (equivalent to ISO 102400) are expanded ISO speed settings, noise (dots of light, banding, etc.) and irregular colors will be more noticeable, and the resolution lower compared with the standard setting.
- As L (equivalent to ISO 50) is an expanded ISO speed setting, the dynamic range will be somewhat narrower compared with the standard setting.
- If [**3: Highlight tone priority**] is set to [**Enable**] (p.199), L (equivalent to ISO 50), ISO 100/125/160, H1 (equivalent to ISO 51200), and H2 (equivalent to ISO 102400) cannot be selected.
- When shooting with a high ISO speed, high temperature, long exposure, or multiple exposure, image noise (rough grain, dots of light, banding, etc.), irregular colors, or color shift may become noticeable.
- When shooting in conditions that produce an extreme amount of noise, such as a combination of high ISO speed, high temperature, and long exposure, images may not be recorded properly.
- If you use a high ISO speed and flash to shoot a close subject, overexposure may result.



With [**ISO speed range**] under [**2: ISO speed settings**], you can expand the settable ISO speed range from L (equivalent to ISO 50) to H1 (equivalent to ISO 51200) or H2 (equivalent to ISO 102400) (p.173).

## ISO Auto

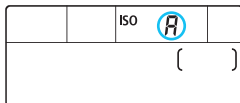

If the ISO speed is set to “**A**” (Auto), the actual ISO speed to be set will be displayed when you press the shutter button halfway.

As indicated below, the ISO speed will be set automatically to suit the shooting mode.

Shooting Modes	ISO Speed	
	No Flash	With Flash
<b>A<sup>+</sup>/CA</b>	ISO 100 - ISO 12800	ISO 100 - ISO 1600
<b>SCN</b>	Automatically set (Varies depending on the <b>SCN</b> shooting mode)	
<b>P/Tv/Av/M</b>	ISO 100 - ISO 40000*	ISO 100 - ISO 1600*
<b>B</b>	ISO 400*	ISO 400*

\* The actual ISO speed range depends on the **[Minimum]** and **[Maximum]** set with **[Auto range]**.



## MENU Setting the Manually-Settable ISO Speed Range

You can set the manually-settable ISO speed range (minimum and maximum limits). You can set the minimum limit within L (equivalent to ISO 50) to H1 (equivalent to ISO 51200), and the maximum limit within ISO 100 to H2 (equivalent to ISO 102400).

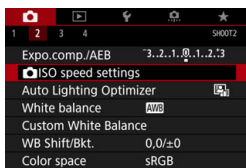

- 1 **Select [ISO speed settings].**
  - Under the [2] tab, select [ISO speed settings], then press <SET>.

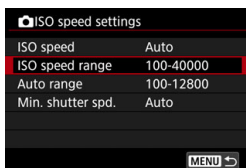

- 2 **Select [ISO speed range].**



- 3 **Set the minimum limit.**
  - Select the minimum limit box, then press <SET>.
  - Select the ISO speed, then press <SET>.



- 4 **Set the maximum limit.**
  - Select the maximum limit box, then press <SET>.
  - Select the ISO speed, then press <SET>.

- 5 **Select [OK].**

**MENU** Setting the ISO Speed Range for ISO Auto

You can set the automatic ISO speed range for ISO Auto within ISO 100 - ISO 40000. You can set the minimum limit within ISO 100 - ISO 25600, and the maximum limit within ISO 200 - ISO 40000.

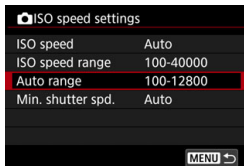
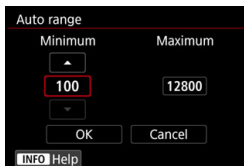
**1** Select [Auto range].**2** Set the minimum limit.

- Select the minimum limit box, then press <SET>.
- Select the ISO speed, then press <SET>.

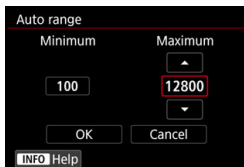
**3** Set the maximum limit.

- Select the maximum limit box, then press <SET>.
- Select the ISO speed, then press <SET>.

**4** Select [OK].

The [Minimum] and [Maximum] settings will also function as the minimum and maximum speeds for ISO speed safety shift (p.473).

**MENU** Setting the Minimum Shutter Speed for ISO Auto

You can set the minimum shutter speed so that the shutter speed set automatically will not be too slow when ISO Auto is set.

This is effective in the <P> and <Av> modes when you use a wide-angle lens to shoot a moving subject or when you use a telephoto lens. It helps to reduce camera shake and blurred subjects.

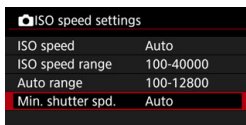
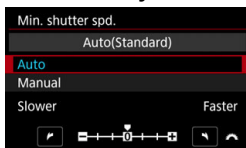
**1** Select [Min. shutter spd.].**Automatically set****2** Set the desired minimum shutter speed.

- Select [Auto] or [Manual].
- If you select [Auto], turn the < > dial to set the desired speed, slower or faster compared to the standard speed, then press < >.
- If you select [Manual], turn the < > dial to select the shutter speed, then press < >.

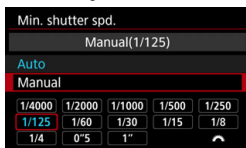
**Manually set**

- If a correct exposure cannot be obtained with the maximum ISO speed limit set with [Auto range], a shutter speed slower than the [Min. shutter spd.] will be set to obtain the standard exposure.
- This function will not be applied to flash photography and movie shooting.



When [Auto: 0] is set, the minimum shutter speed will be the reciprocal of the lens focal length. A single step from [Slower] to [Faster] is equivalent to a single stop of the shutter speed.



## MENU Selecting a Picture Style ☆

Just by selecting a preset Picture Style, you can obtain image characteristics effectively matching your photographic expression or the subject.

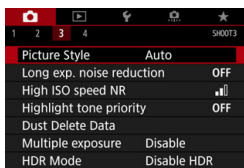
In Basic Zone modes, [] (Auto) is set automatically.



### 1 Select [Picture Style].

- Under the [] tab, select [Picture Style], then press <  >.
- ▶ The Picture Style selection screen will appear.

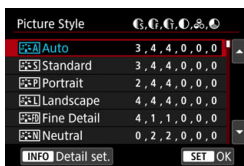

### 2 Select a Picture Style.

- Select a Picture Style, then press <  >.
- ▶ The Picture Style will be set.

## Picture Style Characteristics

### **Auto**

The color tone will be adjusted automatically to suit the scene. The colors will look vivid for blue skies, greenery and sunsets, particularly in nature, outdoor and sunset scenes.



If the desired color tone is not obtained with **[Auto]**, use another Picture Style.

### **Standard**

The image looks vivid, sharp, and crisp. This is a general-purpose Picture Style suitable for most scenes.

### **Portrait**

For nice skin tones. The image looks softer. Suited for close-up portraits.

By changing the **[Color tone]** (p.181), you can adjust the skin tone.

### **Landscape**

For vivid blues and greens, and very sharp and crisp images. Effective for impressive landscapes.

### **Fine Detail**

Suited for detailed outline and fine texture description of the subject. The colors will be slightly vivid.

### **Neutral**

Suited for processing the image with a computer. For natural colors and subdued images with modest brightness and color saturation.



### **Faithful**

Suited for processing the image with a computer. The color of a subject that is captured in sunlight at a color temperature of 5200K will be adjusted to match the subject's colorimetric color. For subdued images with modest brightness and color saturation.

### **Monochrome**

Creates black-and-white images.

 Be careful not to leave the **[Monochrome]** setting on when you want to shoot photos in color again. Black-and-white images shot in JPEG cannot be turned into color.

 You can set the camera to display  in the viewfinder and on the LCD panel for when **[Monochrome]** is set (p.489).

### **User Defined 1-3**

You can register a basic style such as **[Portrait]**, **[Landscape]**, a Picture Style file, etc. and adjust it as desired (p.183). With any of the User Defined Picture Style that has not yet been set, pictures will be taken with the same characteristics settings as with the default settings of **[Auto]**.

## Symbols

The Picture Style selection screen has icons for **[Strength]**, **[Fineness]**, or **[Threshold]** for **[Sharpness]** as well as **[Contrast]** and other parameters. The numerals indicate the values for these parameters set for the respective Picture Style.

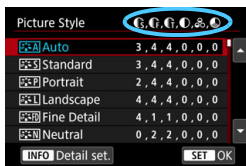

## Symbols

	Sharpness	
		Strength
		Fineness
	Threshold	
	Contrast	
	Saturation	
	Color tone	
	Filter effect (Monochrome)	
	Toning effect (Monochrome)	

During movie shooting, an asterisk “\*” will be displayed for both **[Fineness]** and **[Threshold]** for **[Sharpness]**. **[Fineness]** and **[Threshold]** will not be applied to movies.

## MENU Customizing a Picture Style ☆

You can customize the Picture Styles. You can change or adjust the parameter settings of Picture Styles such as **[Strength]**, **[Fineness]**, or **[Threshold]** for **[Sharpness]** as well as **[Contrast]** and other parameters from the default settings. To see the resulting effects, take test shots. To customize **[Monochrome]**, see page 182.

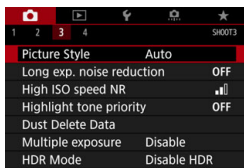

### 1 Select [Picture Style].

- Under the [CAMERA] tab, select **[Picture Style]**, then press <SET>.
- ▶ The Picture Style selection screen will appear.



### 2 Select a Picture Style.

- Select the Picture Style to be adjusted, then press the <INFO> button.

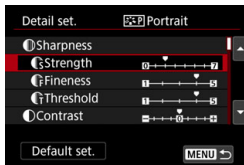

### 3 Select a parameter.

- Select the parameter (such as **[Strength]** of **[Sharpness]**) to be set, then press <SET>.
- See the next page for settings and effects.



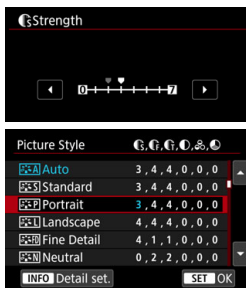

## 4 Set the parameter.

- Press the <◀> <▶> keys to adjust the parameter, then press <SET>.
- Press the <MENU> button to save the adjusted parameter settings. The Picture Style selection screen will reappear.
- ▶ The value of parameter settings different from the default will be displayed in blue.

## Parameter Settings and Effects

	Sharpness		
●	Strength	0: Weak outline emphasis	7: Strong outline emphasis
●	Fineness* <sup>1</sup>	1: Fine	5: Grainy
●	Threshold* <sup>2</sup>	1: Low	5: High
●	Contrast	-4: Low contrast	+4: High contrast
●	Saturation	-4: Low saturation	+4: High saturation
●	Color tone	-4: Reddish skin tone	+4: Yellowish skin tone

\*1: Indicates the fineness of the outlines to be emphasized. The smaller the number, the finer the outlines that can be emphasized.

\*2: Sets how much the outline is emphasized based on the difference in contrast between the subject and the surrounding area. The smaller the number, the more the outline will be emphasized when the contrast difference is low. However, noise tends to be more noticeable when the number is smaller.



- For movie shooting, [Fineness] and [Threshold] for [Sharpness] cannot be set (not displayed).
- By selecting [Default set.] in step 3, you can revert the parameter settings of the respective Picture Style to their defaults.
- To shoot with the Picture Style you adjusted, first select the adjusted Picture Style, then shoot.

## Monochrome Adjustment

Besides the effects described on the preceding page such as **[Contrast]**, or **[Strength]**, **[Fineness]** and **[Threshold]** for **[Sharpness]**, you can also set **[Filter effect]** and **[Toning effect]**.

### Filter effect

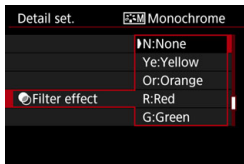

With a filter effect applied to a monochrome image, you can make white clouds or green trees stand out more.

Filter	Sample Effects
N: None	Normal black-and-white image with no filter effects.
Ye: Yellow	The blue sky will look more natural, and the white clouds will look crisper.
Or: Orange	The blue sky will look slightly darker. The sunset will look more brilliant.
R: Red	The blue sky will look quite dark. Fall leaves will look crisper and brighter.
G: Green	Skin tones and lips will appear muted. Green tree leaves will look crisper and brighter.

 Increasing the **[Contrast]** will make the filter effect more pronounced.

### Toning effect

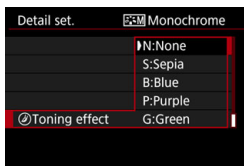

By applying a toning effect, you can create a monochrome image in the selected color. Effective when you want to create more impressive images. The following can be selected: **[N:None]**, **[S:Sepia]**, **[B:Blue]**, **[P:Purple]** or **[G:Green]**.

## MENU Registering a Picture Style ☆

You can select a base Picture Style such as **[Portrait]** or **[Landscape]**, adjust its parameters as desired and register it under **[User Def. 1]**, **[User Def. 2]**, or **[User Def. 3]**. Useful when you want to preset multiple Picture Styles with different settings.

You can also adjust the parameters of a Picture Style that is registered to the camera with EOS Utility (EOS software, p.594) here.

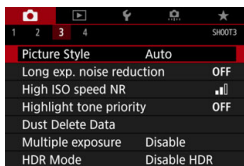

### 1 Select [Picture Style].

- Under the [**3**] tab, select **[Picture Style]**, then press <SET>.
- ▶ The Picture Style selection screen will appear.

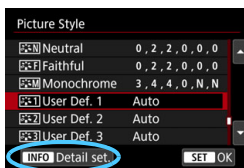

### 2 Select [User Def. \*].

- Select **[User Def. \*]**, then press the <INFO> button.

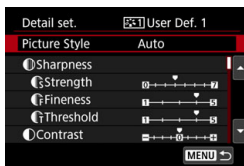

### 3 Press <SET>.

- With **[Picture Style]** selected, press <SET>.

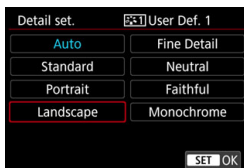

### 4 Select the base Picture Style.

- Select the base Picture Style, then press <SET>.
- To adjust the parameters of a Picture Style registered to the camera with EOS Utility (EOS software), select the Picture Style here.

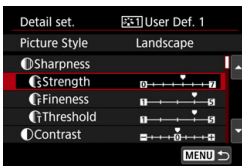

## 5 Select a parameter.

- Select the parameter (such as **[Strength]** under **[Sharpness]**) to be set, then press **<SET>**.



## 6 Set the parameter.

- Adjust the effect level of the parameter, then press **<SET>**. For details, see “Customizing a Picture Style” (p.180).
- Press the **<MENU>** button to register the adjusted parameter settings. The Picture Style selection screen will then reappear.
  - ▶ The base Picture Style will be indicated on the right of **[User Def. \*]**.
  - ▶ If the parameter settings in the Picture Style registered under **[User Def. \*]** have been modified from the default, the Picture Style's name will be displayed in blue.

- If a Picture Style is already registered under **[User Def. \*]**, changing the base Picture Style in step 4 will clear the parameter settings of the previously registered User Defined Picture Style.
- If you perform **[☛5: Clear all camera settings]** (p.75), all the **[User Def. \*]** settings will revert to their defaults.

- To shoot with a registered Picture Style, select the registered **[User Def. \*]**, then shoot.
- Regarding the procedure to register a Picture Style file to the camera, refer to the EOS Utility Instruction Manual (p.596).

# WB: Setting the White Balance ☆

White balance (WB) is for making the white areas look white. Normally, the Auto [**AWB**] (Ambience priority) or [**AWB w**] (White priority) setting will obtain the correct white balance. If natural-looking colors cannot be obtained with Auto, you can select the white balance to match the light source or set it manually by shooting a white object.

In Basic Zone modes, [**AWB**] (Ambience priority) is set automatically. (In the <M/|> mode, [**AWB w**] (White priority) is set.)

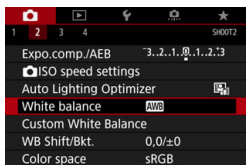

## 1 Select [White balance].

- Under the [**2**] tab, select [**White balance**], then press <SET>.

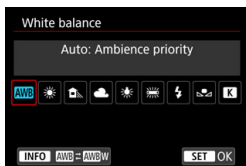

## 2 Select a white balance setting.

- Select the desired setting, then press <SET>.

(Approx.)

Display	Mode	Color Temperature (K: Kelvin)
<b>AWB</b>	Auto (Ambience priority, p.187)	3000 - 7000
<b>AWB w</b>	Auto (White priority, p.187)	
	Daylight	5200
	Shade	7000
	Cloudy, twilight, sunset	6000
	Tungsten light	3200
	White fluorescent light	4000
	Flash use	Automatically set*
	Custom (p.188)	2000 - 10000
<b>K</b>	Color temperature (p.190)	2500 - 10000

\* Applicable with Speedlites having a color temperature transmission function. Otherwise, it will be fixed to approx. 6000 K.

## White Balance

To the human eye, a white object looks white regardless of the type of lighting. With a digital camera, the white for color correction basis is decided depending on the color temperature of the illumination, and then the color is adjusted with software to make the white areas look white. With this function, you can take the pictures with natural color tones.

## **[AWB]** Auto White Balance

With **[AWB]** (Ambience priority), you can increase the intensity of the image's warm color cast when shooting a tungsten-light scene. If you select **[AWB w]** (White priority), you can reduce the intensity of the image's warm color cast.

If you want to match the Auto white balance of previous EOS DIGITAL camera models, select **[AWB]** (Ambience priority).

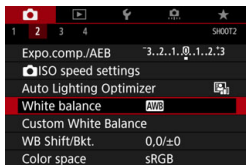

### 1 Select **[White balance]**.

- Under the **[CAMERA]** tab, select **[White balance]**, then press **<SET>**.

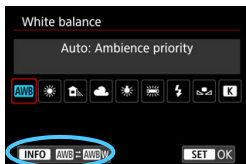

### 2 Select **[AWB]**.

- With **[AWB]** selected, press the **<INFO>** button.

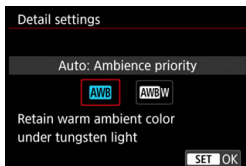

### 3 Select the desired item.

- Select **[Auto: Ambience priority]** or **[Auto: White priority]**, then press **<SET>**.

**[AWB]** : Auto: Ambience priority

**[AWB w]** : Auto: White priority



### Cautions for Setting **[AWB w]** (White priority)

- The warm color cast of subjects may fade.
- When multiple light sources are included in the scene, the warm color cast of the picture may not be lessened.
- When using flash, the color tone will be the same as with **[AWB]** (Ambience priority).

## 📷 Custom White Balance

With custom white balance, you can manually set the white balance for the specific light source of the shooting location. Make sure to perform this procedure under the light source at the actual location of the shoot.

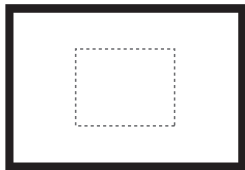

### 1 Shoot a white object.

- Look through the viewfinder and aim the entire dotted line box (shown in the illustration) over a plain, white object.
- Focus manually and shoot with the standard exposure set for the white object.
- You can use any of the white balance settings.

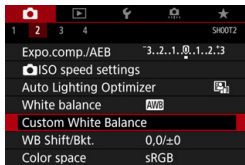

### 2 Select [Custom White Balance].

- Under the [📷2] tab, select [Custom White Balance], then press <SET>.
- ▶ The custom white balance selection screen will appear.



### 3 Import the white balance data.

- Turn the <🕒> dial to select the image captured in step 1, then press <SET>.
- ▶ On the dialog screen that appears, select [OK], and the data will be imported.
- Press the <MENU> button to exit the menu.



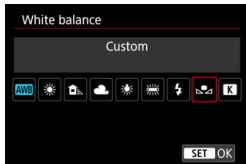

#### 4 Select [White balance].

- Under the [📷2] tab, select [White balance], then press <SET>.

#### 5 Select the custom white balance.

- Select [📷], then press <SET>.



- If the exposure obtained in step 1 differs greatly from the standard exposure, a correct white balance may not be obtained.
- In step 3, the following images cannot be selected: Images captured with the Picture Style set to [Monochrome], multiple-exposure images, cropped images, and images shot with another camera.



Instead of shooting a white object, you can also shoot a gray chart or standard 18% gray reflector (commercially-available).

## K Setting the Color Temperature

You can set the white balance's color temperature numerically. This is for advanced users.

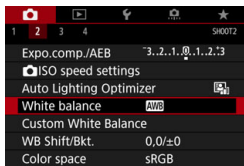

### 1 Select [White balance].

- Under the [📷2] tab, select [White balance], then press <SET>.

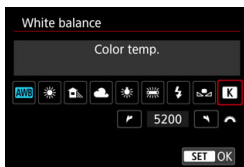

### 2 Set the color temperature.

- Select [K].
- Turn the <🔧> dial to set the desired color temperature, then press <SET>.
- The color temperature can be set from approx. 2500 K to 10000 K in 100 K increments.



- When setting the color temperature for an artificial light source, set the white balance correction (magenta or green bias) as necessary.
- If you set [K] to the reading taken with a commercially-available color temperature meter, take test shots and adjust the setting to compensate for the difference between the color temperature meter's reading and the camera's color temperature reading.

# WB White Balance Correction ☆

You can correct the white balance that is set. This adjustment will have the same effect as using a commercially-available color temperature conversion filter or color compensating filter. Each color can be corrected to one of nine levels. This function is for advanced users, particularly for those users who understand the use of color temperature conversion and color compensating filters and their effects.

## White Balance Correction

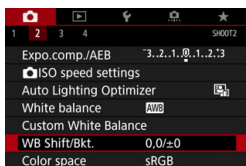

### 1 Select [WB Shift/Bkt.].

- Under the [CAMERA] tab, select [WB Shift/Bkt.], then press <SET>.

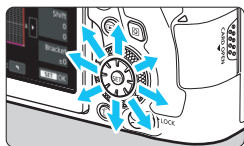

Sample setting: A2, G1

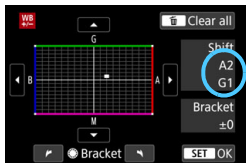

### 2 Set the white balance correction.

- Use <DIAL> to move the “■” mark to the appropriate position.
- B is for blue, A for amber, M for magenta, and G for green. The image’s color balance will be adjusted toward the color in the direction of the move.
- On the right of the screen, “Shift” indicates the direction and correction amount, respectively.
- Pressing the <CANCEL> button will cancel all the [WB Shift/Bkt.] settings.
- Press <SET> to exit the setting.



- You can set the camera to display <WB> in the viewfinder and on the LCD panel for when white balance correction has been set (p.489).
- One level of the blue/amber correction is equivalent to approx. 5 mireds of a color temperature conversion filter. (Mired: Unit of measure for color temperature used to indicate values such as the density of a color temperature conversion filter.)

## White Balance Auto Bracketing

With just one shot, three images with different color tones can be recorded simultaneously. Based on the color temperature of the current white balance setting, the image will be bracketed with a blue/amber bias and magenta/green bias. This function is called white balance bracketing (WB Bkt.). White balance bracketing is possible up to  $\pm 3$  levels in single-level increments.

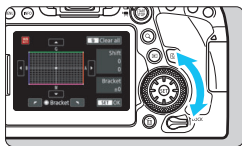

B/A bias  $\pm 3$  levels

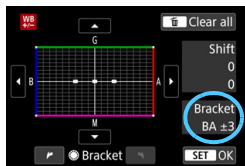

### Set the white balance bracketing amount.

- In step 2 for “White Balance Correction”, when you turn the  $\langle \odot \rangle$  dial, the “■” mark on the screen will change to “■■■” (3 points). Turning the dial clockwise sets the B/A bracketing, and turning it counterclockwise sets the M/G bracketing.
- ▶ On the right, “**Bracket**” indicates the bracketing direction and correction amount.
- Pressing the  $\langle \text{Clear} \rangle$  button will cancel all the [WB Shift/Bkt.] settings.
- Press  $\langle \text{SET} \rangle$  to exit the setting.

### ● Bracketing Sequence

The images will be bracketed in the following sequence: 1. Standard white balance, 2. Blue (B) bias, and 3. Amber (A) bias, or 1.

Standard white balance, 2. Magenta (M) bias, and 3. Green (G) bias.



- During white balance bracketing, the maximum burst for continuous shooting will be lower.
- Since three images are recorded for one shot, it takes longer to record the image to the card.



- You can also set white balance correction and AEB together with white balance bracketing. If you set AEB in combination with white balance bracketing, a total of nine images will be recorded for a single shot.
- During Live View shooting with WB bracketing set, the white balance icon will blink.
- You can change the sequence (p.472) and number of shots (p.472) for the white balance bracketing.
- “**Bkt.**” stands for bracketing.

## MENU Auto Correction of Brightness and Contrast ☆

If the image comes out dark or the contrast is low, the brightness and contrast can be corrected automatically. This function is called Auto Lighting Optimizer. The default setting is [**Standard**]. With JPEG images, the correction is applied when the image is captured. In Basic Zone modes, [**Standard**] is set automatically.

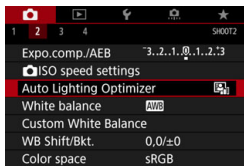

### 1 Select [Auto Lighting Optimizer].

- Under the [**2**] tab, select [**Auto Lighting Optimizer**], then press <SET>.

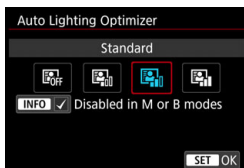

### 2 Select the setting.

- Select the desired setting, then press <SET>.

### 3 Take the picture.

- The image will be recorded with the brightness and contrast corrected as necessary.

- Depending on the shooting conditions, noise may increase.
- If the effect of Auto Lighting Optimizer is too strong and the image is too bright, set [**Low**] or [**Disable**].
- If a setting other than [**Disable**] is set and you use exposure compensation or flash exposure compensation to darken the exposure, the image may still come out bright. If you want a darker exposure, set this function to [**Disable**].
- When you set multiple exposures (p.258), HDR mode (p.253), or highlight tone priority (p.199), [**2: Auto Lighting Optimizer**] will be automatically set to [**Disable**].

In step 2, if you press the <INFO> button and remove the checkmark [✓] for [**Disabled in M or B modes**] setting, the [**2: Auto Lighting Optimizer**] can also be set even in the <M> and <B> modes.

# MENU Setting Noise Reduction ☆

## High ISO Speed Noise Reduction

This function reduces the noise generated in the image. Although noise reduction is applied at all ISO speeds, it is particularly effective at high ISO speeds. When shooting at low ISO speeds, the noise in the darker parts of the image (shadow areas) can further be reduced.

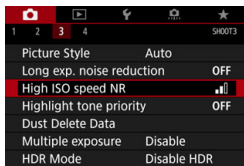

### 1 Select [High ISO speed NR].

- Under the [CAMERA] tab, select [High ISO speed NR], then press <SET>.

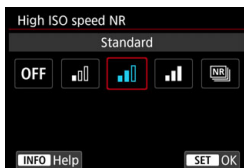

### 2 Set the level.

- Select the desired noise reduction level, then press <SET>.

### ● [NR] : Multi Shot Noise Reduction

Applies the noise reduction with higher image quality than [High]. For a single photo, four shots are taken continuously and aligned and merged automatically into a single JPEG image.

If the image-recording quality is set to RAW or RAW+JPEG, you cannot set [Multi Shot Noise Reduction].

### 3 Take the picture.

- The image will be recorded with noise reduction applied.



You can set the camera to display <M> in the viewfinder and on the LCD panel for when Multi Shot Noise Reduction is set (p.489).



### Cautions for Setting Multi Shot Noise Reduction

- If there is significant misalignment in the image due to camera shake, the noise reduction effect may become smaller.
- If you are handholding the camera, keep it steady to prevent camera shake. Using a tripod is recommended.
- If you shoot a moving subject, the moving subject may leave afterimages.
- Auto image alignment may not function properly with repetitive patterns (lattice, stripes, etc.) or flat, single-tone images.
- If the subject's brightness changes as the four consecutive shots are taken, irregular exposure in the image may result.
- After shooting, it may take some time to record an image to the card after performing noise reduction and merging the images. During the processing of the images, "buSY" will be displayed in the viewfinder and on the LCD panel, and you cannot take another picture until the processing is complete.
- You cannot use AEB and white balance bracketing.
- If [**3: Long exp. noise reduction**], [**3: Multiple exposure**], [**3: HDR Mode**], AEB shooting, white balance bracketing, or Live View shooting with Servo AF is set, [**Multi Shot Noise Reduction**] cannot be set.
- This cannot be set for bulb shooting.
- Flash photography is not possible. Note that the AF-assist beam of EOS-dedicated, external Speedlites will be emitted according to the [**C.Fn II-6: AF-assist beam firing**] setting.
- [**Standard**] will be set automatically if you do any of the following: Setting the power switch to <OFF>, replacing battery, replacing card, setting shooting mode to other than <P>, <Tv>, <Av>, or <M>, or switching to movie shooting.



## Long Exposure Noise Reduction

For images exposed for 1 sec. or longer, noise (dots of light and banding) typical of long exposures can be reduced.

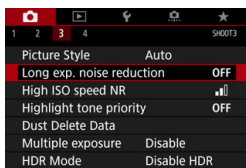

### 1 Select [Long exp. noise reduction].

- Under the [**3**] tab, select [**Long exp. noise reduction**], then press < (SET) >.

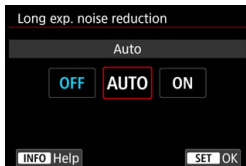

### 2 Set the desired setting.

- Select the desired setting, then press < (SET) >.

#### • Auto

For exposures of 1 sec. or longer, noise reduction is performed automatically if noise typical of long exposures is detected. This [**Auto**] setting is effective enough in most cases.

#### • Enable

Noise reduction is performed for all exposures of 1 sec. or longer. The [**Enable**] setting may reduce noise that cannot be detected with the [**Auto**] setting.

### 3 Take the picture.

- The image will be recorded with noise reduction applied.

- With **[Auto]** or **[Enable]** set, the noise reduction process after the picture is taken may take the same amount of time as that for the exposure. However, even when noise reduction process is in progress, you can continue to take pictures as long as the maximum burst indicator in the viewfinder shows “1” or higher.
- Images taken at high ISO speeds may look grainier with the **[Enable]** setting than with the **[Disable]** or **[Auto]** setting.
- With **[Auto]** or **[Enable]** set, if long exposure is used with the Live View image displayed, “**BUSY**” will be displayed during the noise reduction process. The Live View display will not appear until the noise reduction is complete. (You cannot take another picture.)

## MENU Highlight Tone Priority ☆

You can reduce overexposed, clipped highlights.

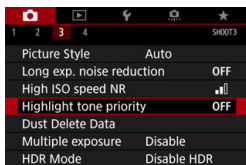

### 1 Select [Highlight tone priority].

- Under the [**3**] tab, select **[Highlight tone priority]**, then press **<SET>**.

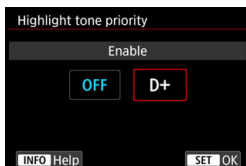

### 2 Select [Enable].

- Highlight details are improved. The dynamic range is expanded from the standard 18% gray to bright highlights. The gradation between the grays and highlights becomes smoother.

### 3 Take the picture.

- The image will be recorded with highlight tone priority applied.



- When **[Enable]** is set, noise may increase slightly.
- When **[Enable]** is set, the settable ISO speed range will start from ISO 200. Expanded ISO speeds cannot be set.
- When you set multiple exposures (p.258) or HDR mode (p.253), [**3**]: **Highlight tone priority**] will be automatically set to **[Disable]**.



When highlight tone is set, **<D+>** is displayed in the viewfinder and on the LCD panel.

## MENU Correction of Lens Aberrations due to Optical Characteristics ☆

Peripheral light fall-off is a phenomenon that makes the image corners look darker due to the optical characteristics of the lens. Color fringing along subject outlines is called chromatic aberration. Image distortion due to optical characteristics of the lens is called distortion. And decreased image sharpness due to the aperture is called diffraction phenomenon. These lens aberrations can be corrected.

By default, **[Peripheral illum corr]**, **[Chromatic aberr corr]**, and **[Diffraction correction]** are set to **[Enable]**, and **[Distortion correction]** is set to **[Disable]**.

If the lens correction data is registered (saved) in the camera, peripheral illumination correction, chromatic aberration correction, and diffraction correction will be applied in Basic Zone modes. (In the <iii> mode, distortion correction is also applied.)

If the setting screen displays **[Correction data not available]** or the [🗑️] icon, it means that the correction data for the respective lens is not registered in the camera. See “Lens Correction Data” on page 204.

### Peripheral Illumination Correction

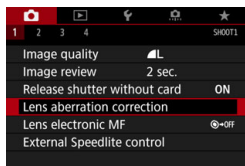

#### 1 Select [Lens aberration correction].

- Under the [📷1] tab, select **[Lens aberration correction]**, then press <SET>.

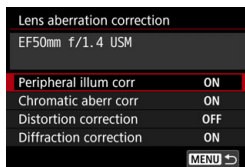

#### 2 Select [Peripheral illum corr].

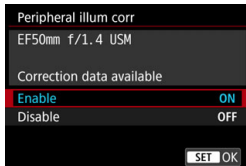

### 3 Select [Enable].

- Check that [**Correction data available**] is displayed for the attached lens.
- Select [**Enable**], then press < >.

### 4 Take the picture.

- The image will be recorded with the peripheral illumination corrected.



- Depending on shooting conditions, noise may appear on the image periphery.
- The higher the ISO speed, the lower the correction amount will be.



The correction amount applied will be lower than the maximum correction amount that can be applied with Digital Photo Professional (EOS software, p.594).

## Chromatic Aberration Correction

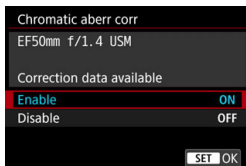

### 1 Select [Chromatic aberr corr].

### 2 Select [Enable].

- Check that [**Correction data available**] is displayed for the attached lens.
- Select [**Enable**], then press < >.

### 3 Take the picture.

- The image will be recorded with the chromatic aberration corrected.

## Distortion Correction

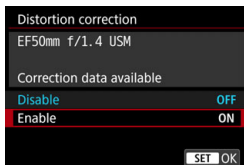

1 Select [Distortion correction].

2 Select [Enable].

- Check that [Correction data available] is displayed for the attached lens.
- Select [Enable], then press < (SET) >.

3 Take the picture.

- The image will be recorded with the distortion corrected.

- Since distortion correction is applied, the camera records an image range narrower than the one seen through the viewfinder. (The image periphery is slightly trimmed and the resolution looks slightly lowered.)
- You cannot see the effect of the distortion correction in the viewfinder.
- During movie shooting, [Distortion correction] will not be displayed (correction is not possible).
- Using distortion correction during Live View shooting will slightly affect the angle of view.
- When you magnify the image during Live View shooting, distortion correction is not applied to the image displayed. Therefore, magnifying the periphery of the image may display parts of the image that will not be recorded.
- Images with distortion correction applied will not have the Dust Delete Data (p.452) appended. Also, the AF point(s) will not be displayed (p.397) for image playback.

## Diffraction Correction

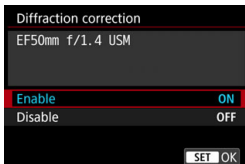

1 Select [Diffraction correction].

2 Select [Enable].

- Select [Enable], then press <SET>.

3 Take the picture.

- The image will be recorded with the diffraction corrected.



- Depending on shooting conditions, noise may be intensified together with the effects of correction.
- The higher the ISO speed, the lower the correction amount will be.
- For movie shooting, [Diffraction correction] will not appear. (Correction is not possible.)



With “Diffraction correction”, degraded resolution due to the low-pass filter, etc. is corrected in addition to diffraction. Therefore, correction is effective even at an aperture close to the open aperture.

## Lens Correction Data

The lens correction data for lens aberration corrections is registered (stored) in the camera. With [**Enable**] selected, the peripheral illumination correction, chromatic aberration correction, distortion correction, and diffraction correction will be applied automatically.

With EOS Utility (EOS software, p.594), you can check which lenses have their correction data registered in the camera. You can also register the correction data for unregistered lenses. For details, refer to the EOS Utility Instruction Manual.

For lenses incorporating the correction data, it is not necessary to register the correction data to the camera.





## General Cautions for Lens Aberration Correction

- Peripheral illumination correction, chromatic aberration correction, distortion correction, and diffraction correction cannot be applied to JPEG images already taken.
- When using a non-Canon lens, setting the corrections to **[Disable]** is recommended even if **[Correction data available]** is displayed.
- If you use the magnified view during Live View shooting, the peripheral illumination correction and distortion correction will not be reflected in the image displayed on the screen.
- During Live View shooting, magnifying the periphery of the image may display parts of the image that will not be recorded.
- The correction amount will be less (except for diffraction correction) if the lens used does not have distance information.



## General Notes for Lens Aberration Correction

- The effect of the lens aberration correction varies depending on the lens used and shooting conditions. Also, the effect may be difficult to discern depending on the lens used, shooting conditions, etc.
- If the correction is difficult to discern, magnifying and checking the image after shooting is recommended.
- Corrections can be applied even when an extender or life-size converter is attached.
- If the correction data for the attached lens is not registered to the camera, the result will be the same as when the correction is set to **[Disable]** (except for diffraction correction).

## MENU Reducing Flicker ☆

If you shoot an image with a fast shutter speed under a light source such as fluorescent light, the blinking of the light source causes flicker and the image may be vertically unevenly exposed. If continuous shooting is used under these conditions, uneven exposures or colors across the images may result. When you use this feature during viewfinder shooting, the camera detects the flickering frequency of the light source and takes the picture when the flicker causes less effect on exposure or color tone.

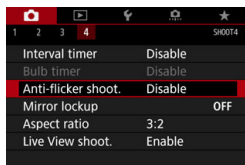

### 1 Select [Anti-flicker shoot.].

- Under the [ 4] tab, select [Anti-flicker shoot.], then press <SET>.

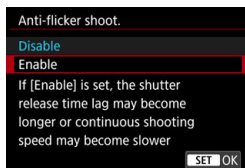

### 2 Select [Enable].

### 3 Take the picture.

- The picture will be taken with reduced unevenness of exposure or color tone caused by the flicker.

- When [Enable] is set and you shoot under a flickering light source, the shutter-release time lag may become longer. Also, the continuous shooting speed may become slower, and the shooting interval may become irregular.
- This function does not work with mirror lockup, Live View shooting, or movie shooting.
- In the <P> or <Av> mode, if the shutter speed changes during continuous shooting or if you shoot multiple shots of the same scene at different shutter speeds, the color tone may become inconsistent. To avoid inconsistent color tones, use the <Tv> or <M> mode at a fixed shutter speed.



- The color tone of the captured images when [**4: Anti-flicker shoot.**] is set to [**Enable**] may look different from when [**Disable**] is set.
- Flicker at a frequency other than 100 Hz or 120 Hz cannot be detected. Also, if the flickering frequency of the light source changes during continuous shooting, effects of the flicker cannot be reduced.
- If the subject is against a dark background or if there is a bright light in the image, flicker may not be properly detected.
- Under certain special types of lighting, the camera may not be able to reduce the effects of the flicker even when < **Flicker!** > is displayed in the viewfinder.
- Depending on the light source, flicker may not be detected properly.
- If you recompose a shot, < **Flicker!** > may appear and disappear intermittently.
- Depending on the light sources or shooting conditions, the expected result may not be obtained even if you use this function.



- Taking test shots in advance is recommended.
- If < **Flicker!** > is not displayed in the viewfinder, add a checkmark [✓] to [**Flicker detection**] in [**Show/hide in viewfinder**] (p.82). When you shoot with flicker reduction, < **Flicker!** > will light up. Under a light source that does not flicker or with no flicker detected, < **Flicker!** > will not be displayed.
- If a checkmark [✓] is added to [**Flicker detection**] and [**4: Anti-flicker shoot.**] is set to [**Disable**], metering under a flickering light source will cause < **Flicker!** > to blink in the viewfinder as a warning. Setting to [**Enable**] before shooting is recommended.
- In Basic Zone modes, < **Flicker!** > will not be displayed, but the effects of flicker will be reduced when you shoot.
- Flicker reduction also works with flash photography. However, the expected result may not be obtained for wireless flash photography.

## MENU Setting the Color Space ☆

The range of reproducible colors is called “color space”. With this camera, you can set the color space for captured images to sRGB or Adobe RGB. For normal shooting, sRGB is recommended. In Basic Zone modes, [sRGB] is set automatically.

### 1 Select [Color space].

- Under the [CAMERA 2] tab, select [Color space], then press <SET>.

### 2 Set the desired color space.

- Select [sRGB] or [Adobe RGB], then press <SET>.

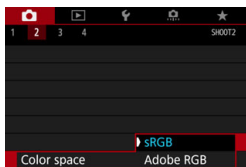

## Adobe RGB

This color space is mainly used for commercial printing and other industrial uses. This setting is not recommended if you are not familiar with image processing, Adobe RGB, and Design rule for Camera File System 2.0 (Exif 2.21 or higher). The image will look very subdued in an sRGB computer environment and with printers not compliant to Design rule for Camera File System 2.0 (Exif 2.21 or higher). Post-processing of the image with computer software will therefore be required.



- If the still photo is shot in the Adobe RGB color space, the first character in the file name will be an underscore “\_”.
- The ICC profile is not appended. For the descriptions about the ICC profile, refer to the Digital Photo Professional Instruction Manual (EOS software, p.596).

## MENU Creating and Selecting a Folder

You can freely create and select the folder where the captured images are to be saved.

This operation is optional since a folder will be created automatically for saving captured images.

### Creating a Folder

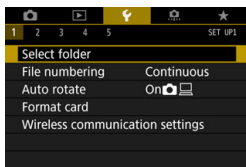

- 1 **Select [Select folder].**
  - Under the [**1**] tab, select [**Select folder**], then press <SET>.

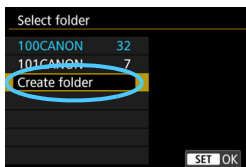

- 2 **Select [Create folder].**

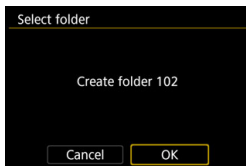

- 3 **Select [OK].**
  - A new folder with the folder number increased by one is created.

## Selecting a Folder

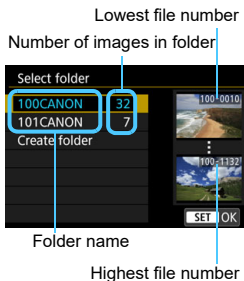

- Select a folder on the folder selection screen, then press  $\langle \text{SET} \rangle$ .
- ▶ The folder where the captured images will be saved is selected.
- Subsequently captured images will be recorded into the selected folder.



### Folders

As with “100CANON” for example, the folder name starts with three digits (the folder number) followed by five alphanumeric characters. A folder can contain up to 9999 images (file number 0001 - 9999). When a folder becomes full, a new folder with the folder number increased by one is created automatically. Also, if manual reset (p.213) is executed, a new folder will be created automatically. Folders numbered from 100 to 999 can be created.

### Creating Folders with a Computer

With the card open on the screen, create a new folder named “DCIM”. Open the DCIM folder and create as many folders as necessary to save and organize your images. The folder name must follow the format “100ABC\_D”. The first three digits are always the folder number from 100 to 999. The last five characters can be any combination of upper- and lower-case letters from A to Z, numerals, and the underscore “\_”. The space cannot be used. Also note that two folder names cannot share the same three-digit folder number (for example, “100ABC\_D” and “100W\_XYZ”) even if the remaining five characters in each name are different.

## MENU File Numbering Methods

The captured images are assigned a sequential four-digit file number from 0001 (Example) **IMG\_0001.JPG** to 9999 and saved in one folder. You can change how the file number is assigned.

File number

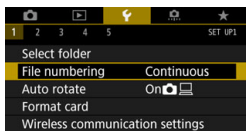

- 1 **Select [File numbering].**
  - Under the [**1**] tab, select [**File numbering**], then press **<SET>**.

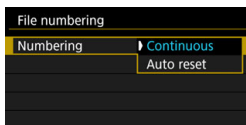

- 2 **Set the file numbering method.**
  - Select [**Numbering**], then press **<SET>**.
  - Select [**Continuous**] or [**Auto reset**], then press **<SET>**.
  - If you want to reset the file numbering, select [**Manual reset**].
  - Select [**OK**] to create a new folder, and the file number will start with 0001.

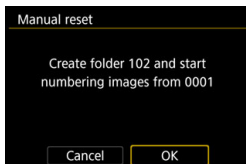
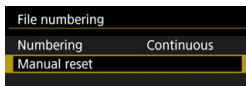

**!** If the file number in folder 999 reaches 9999, shooting will not be possible even if the card still has storage capacity. The LCD monitor will display a message telling you to replace the card. Replace it with a new card.

- !** For both JPEG and RAW images, the file name will start with "IMG\_". Movie file names will start with "MVI\_".
- The extension will be ".JPG" for JPEG images, ".CR2" for RAW images, ".MP4" for movies, and ".MOV" for Time-lapse movies.

## Continuous

**When you wish to continue the file numbering sequence even after the card is replaced or a new folder is created.**

Even after you replace the card or create a new folder, the file numbering continues in sequence up to 9999. This is useful when you want to save images numbered anywhere between 0001 to 9999 on multiple cards or in multiple folders into one folder on a computer.

If the replacement card or existing folder already contains images recorded previously, the file numbering of the new images may continue from the file numbering of the existing images on the card or in the folder. If you want to use continuous file numbering, it is recommended that you use a newly-formatted card each time.

### File numbering after replacing the card    File numbering after creating a folder

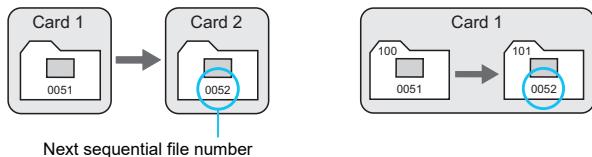



## Auto Reset

**When you wish to restart the file numbering from 0001 each time the card is replaced or a new folder is created.**

When you replace the card or create a folder, the file numbering restarts from 0001 for the new images saved. This is useful if you want to organize images by cards or folders.

If the replacement card or existing folder already contains images recorded previously, the file numbering of the new images may continue from the file numbering of the existing images on the card or in the folder. If you want to save images with the file numbering starting from 0001, use a newly formatted card each time.

**File numbering after replacing the card**      **File numbering after creating a folder**

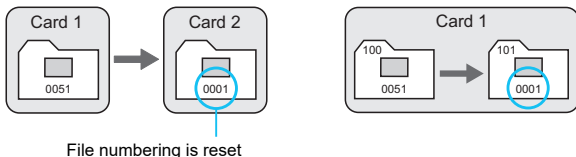

## Manual Reset

**When you wish to reset the file numbering to 0001 or to start from file number 0001 in a new folder.**

When you reset the file numbering manually, a new folder is created automatically and the file numbering of images saved to that folder starts from 0001.

This is useful, for example, if you want to use different folders for the images taken yesterday and the ones taken today.

## MENU Setting Copyright Information ☆

When you set the copyright information, it will be recorded to the image as Exif information.

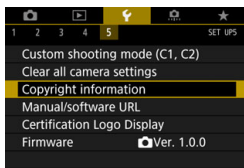

### 1 Select [Copyright information].

- Under the [**5**] tab, select [**Copyright information**], then press <SET>.



### 2 Select the item to be set.

- Select [**Enter author's name**] or [**Enter copyright details**], then press <SET>.

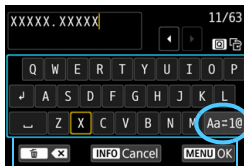

### 3 Enter text.

- Operate the <▲> <▼> <◀> <▶> keys or turn the <☀> or <☺> dial to move the  and select the desired character. Then press <SET> to enter it.
- You can enter up to 63 characters.
- To delete a character, press the <🗑> button.
- By selecting [**Aa↔1@**], you can change the input mode.
- To cancel the text entry, press the <INFO> button, then select [**OK**].

Character palette

Input mode

### 4 Exit the setting.

- After entering the text, press the <MENU> button, then select [**OK**].
- ▶ The set information is saved.

## Checking the Copyright Information

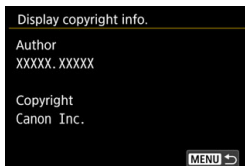

When you select [**Display copyright info.**] in step 2, you can check the [**Author**] and [**Copyright**] information that you entered.

## Deleting the Copyright Information

When you select [**Delete copyright information**] in step 2, you can delete the [**Author**] and [**Copyright**] information.



If the entry for “Author” or “Copyright” is long, it may not be displayed entirely when you select [**Display copyright info.**].



- If you cannot enter text in step 3, press the <Q> button and use the character palette when the blue frame appears.
- You can also set or check the copyright information with EOS Utility (EOS software, p.594).



# 5

## GPS Settings

This chapter describes the camera's built-in GPS settings. The EOS 6D Mark II can receive satellite navigation signals from GPS satellites (USA), GLONASS satellites (Russia), and Quasi-Zenith Satellite System (QZSS) "Michibiki" (Japan).

- The GPS function is set to **[Disable]** by default.
- This manual uses the term "GPS" to refer to the satellite navigation function.

When **[GPS]** is set to **[Mode 1]** (p.221), the camera will continue to receive GPS signals at regular intervals even after the camera's power switch is set to **<OFF>**. The battery will thereby drain faster and the number of possible shots will decrease. When you do not use GPS, setting **[GPS]** to **[Disable]** or **[Mode 2]** is recommended.



When using GPS function, be sure to check the countries and regions where its use is allowed, and use the function in accordance with the laws and regulations of the country or region. Be particularly careful when using GPS outside your home country.

# GPS Features

## Geotagging Images

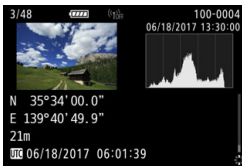

- Geotag information\*<sup>1</sup> (latitude, longitude, elevation) and coordinated universal time\*<sup>2</sup> can be appended to images.
- Shooting locations of geotagged images can be displayed on a map on a computer.

\*1: Certain traveling conditions or GPS settings may cause inaccurate geotag information to be added to images.

\*2: Coordinated Universal Time, abbreviated as UTC, is essentially the same as Greenwich Mean Time.

## Logging the Route Traveled

You can use the GPS logging function to automatically record the route the camera travels by logging location information at set intervals. The location information for the route the camera has traveled can be viewed on a map displayed on a computer.

\* Certain traveling conditions, locations, or GPS settings may cause inaccurate geotag information to be added to images.

## Setting the Camera Time

The time information obtained from GPS signals can be set on the camera.



The GPS information recorded to the images and movies may include information that can personally identify yourself. Therefore, be careful when giving geotagged still photos or movies to other people or displaying them online to the public.

# GPS Precautions

## ■ Countries and Regions Permitting GPS Function Use

Use of GPS function is restricted in some countries and regions, and illegal use may be punishable under national or local regulations. To avoid violating GPS function regulations, visit the Canon Web site to check where the use is allowed.

Note that Canon cannot be held liable for any problems arising from GPS function use in other countries and regions.

## ■ Model Number

EOS 6D Mark II : DS126631

(including GPS module model: ES300)

- In certain countries and regions, the use of GPS function may be restricted. Therefore, be sure to use GPS function in accordance with the laws and regulations of your country or region. Be particularly careful when using GPS function outside your home country.
- Be careful about using GPS function where the operation of electronic devices is restricted.
- Others may be able to locate or identify you by using location data in your geotagged pictures or movies. Be careful when sharing these geotagged images, movies or GPS log files with others, such as when posting them online where many people can view them.
- GPS signal reception may take a longer time in some cases.

Hereby, Canon Inc., declares that this DS126631 is in compliance with the essential requirements and other relevant provisions of Directive 2014/53/EU. The full text of the EU declaration of conformity is available at the following internet address: <http://www.canon-europe.com/ce-documentation>

GPS Specifications

Frequency band(s): 1575.42±1.023 MHz, 1597.5515 - 1605.886MHz

## **CANON EUROPA N.V.**

Bovenkerkerweg 59, 1185 XB Amstelveen, The Netherlands

## **CANON INC.**

30-2, Shimomaruko 3-chome, Ohta-ku, Tokyo 146-8501, Japan



# Acquiring GPS Signals

To acquire GPS signals, take the camera outside where the sky is unobstructed. Face the top of the camera toward the sky while keeping your hands, etc. away from the camera top.

When the signal acquisition conditions are good, it will take the camera approx. 30 sec. to 60 sec. to acquire the GPS satellite signals after you set [GPS] to [Mode 1] or [Mode 2]. Check that [GPS] is displayed on the LCD panel, then shoot.

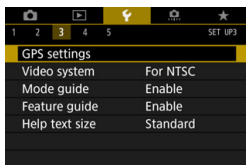

## 1 Select [GPS settings].

- Under the [**3**] tab, select [**GPS settings**], then press <SET>.

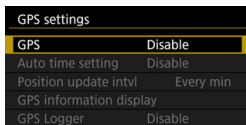

## 2 Select [GPS].

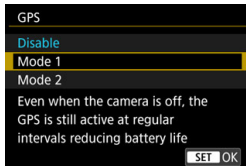

## 3 Select the mode.

- Select [**Mode 1**] or [**Mode 2**].
- [**GPS**] will be displayed on the LCD panel.

### • Mode 1

The camera will continue to receive GPS signals at regular intervals even when the power switch is set to <ON> or <OFF>.

### • Mode 2

When the power switch is set to <ON>, the camera will receive GPS signals. When the power switch is set to <OFF>, the GPS function will also turn off. However, if auto power off is in effect, the camera will continue to receive GPS signals at regular intervals.

## GPS Acquisition Status



The GPS acquisition status is indicated by the [GPS] icon displayed on the camera's LCD panel.

**Constant [GPS] : Signal acquired**

**Blinking [GPS] : Signal not acquired yet**

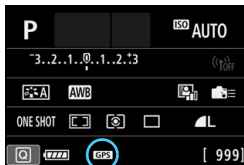

When you shoot while [GPS] is constantly displayed, the image will be geotagged.

- !
 When **[Mode 1]** is set, the camera will continue to receive GPS signals at regular intervals even when the power switch is set to <OFF>. This will exhaust the battery sooner and fewer shots can be taken. If you will not use the camera for a prolonged period, set it to **[Disable]**.
- When **[Mode 2]** is set, the camera will continue to receive GPS signals at regular intervals even during auto power off. Therefore, if auto power off is prolonged, the battery will drain faster and fewer shots can be taken. If you will not use the camera for a prolonged period, set the power switch to <OFF>.
- The built-in GPS antenna is located in front of the hot shoe on the right when viewed from the back of the camera (p.28). Note that GPS signal can be acquired even when an external Speedlite is attached to the hot shoe, but the acquisition sensitivity will slightly decrease.
- GPS Receiver GP-E2 (sold separately) cannot be used.



### Poor GPS Coverage

Under the following conditions, the GPS satellite signal will not be properly acquired. As a result, the geotag information may not be recorded or inaccurate geotag information may be recorded.

- Indoors, underground, in tunnels or forests, between buildings, or in valleys.
- Near high-voltage power lines or mobile phones operating on the 1.5 GHz band.
- When the camera is left inside a bag, etc.
- When traveling a long distance.
- When traveling through different environments.
- Since GPS satellites move as time passes, satellite movement can interfere with geotagging and cause missing or inaccurate location information even in conditions other than the above. Additionally, the location information may also include different location information with a route traveled even if the camera was used at just one location.



- The battery level may be low when you start using the camera due to the effect of the GPS function. If necessary, recharge the battery or prepare a charged, spare battery (sold separately).
- The camera can receive GPS signals even when shooting in the vertical orientation.

## Viewing GPS Information

- 1 **Check the [GPS] setting.**
  - Check that [GPS] is set to [Mode 1] or [Mode 2].
- 2 **Select [GPS information display].**
  - ▶ The GPS information will be displayed.

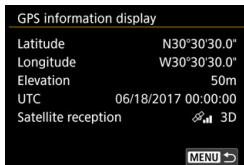
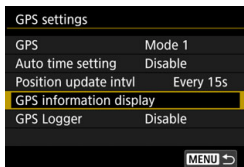

- 3 **Take the picture.**
  - When you shoot after GPS signal acquisition, the image will be geotagged.

Generally, elevation is not as accurate as latitude and longitude due to the nature of GPS.

- The icon indicates signal conditions. When <3D> is displayed, the elevation is also recorded. Note that the elevation cannot be recorded when <2D> is displayed.
- UTC (Coordinated Universal Time) is essentially the same as Greenwich Mean Time.

## Geotagging Information

Play back the images and press the <INFO> button to display the shooting information screen (p.392). Then tilt <☉> up or down to check the geotag information.



UTC (Coordinated Universal Time)



When you shoot a movie, the GPS information at the time when shooting begins is recorded. Note that signal reception conditions are not recorded.

# Setting the Positioning Interval

The interval (time) to update the geotag information can be set. Although updating the geotag information at shorter intervals will record more accurate location information, it will reduce the number of possible shots because it will drain the battery faster.

## 1 Check the [GPS] setting.

- Check that [GPS] is set to [Mode 1] or [Mode 2].

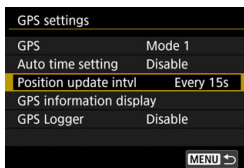

## 2 Select [Position update intvl].

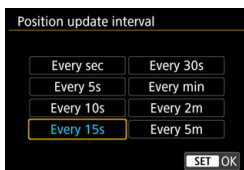

## 3 Set the desired update interval.

- Select the option to be set, then press <SET>.

- If you are in a location where the GPS acquisition condition is not good, the number of possible shots will decrease.
- The nature of GPS may cause some inconsistency in update intervals.

# Setting Time from GPS on the Camera

The time information obtained from GPS signals can be set on the camera. The margin of error is approx.  $\pm 1$  sec.

## 1 Check the [GPS] setting.

- Check that [GPS] is set to [Mode 1] or [Mode 2].

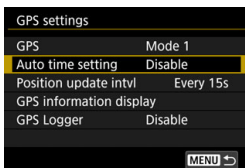

## 2 Select [Auto time setting].

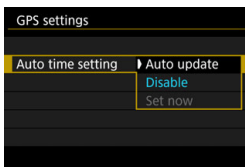

## 3 Select the desired setting.

- Select [Auto update] or [Set now], then press  $\langle \text{SET} \rangle$ .
- [Auto update] updates the time when the camera is turned on and a GPS signal is received.



- If signals from at least five GPS satellites cannot be acquired, the time cannot be auto updated. [Set now] will be grayed out and not selectable.
- Even if [Set now] can be selected, updating the time may not be possible due to an unfavorable timing of the GPS signal acquisition.
- When [Auto time setting] is set to [Auto update], the date or time cannot be manually set with [**2**: Date/Time/Zone].

# Logging the Route Traveled



Map data ©2017 ZENRIN

When using the GPS logging function, the geotag information of the route the camera travels is automatically recorded in the camera's internal memory.

## 1 Check the [GPS] setting.

- Check that [GPS] is set to [Mode 1] or [Mode 2].

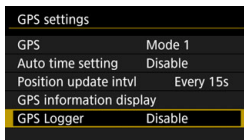

## 2 Select [GPS Logger].

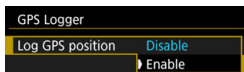

## 3 Set [Log GPS position] to [Enable].

- Select [Log GPS position], then press  $\langle \text{SET} \rangle$ .
- Select [Enable], then press  $\langle \text{SET} \rangle$ .
- ▶ [LOG] will be displayed on the LCD panel.

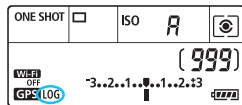

- With [GPS] set to [Mode 1], the GPS logging function will continue to work even when the power switch is set to <OFF>.
- When [Mode 2] is set, setting the power switch to <OFF> will also turn off the GPS logging function. However, the GPS logging function will continue to work during auto power off.



## Geotag Information Logs

Geotag information for the route the camera travels is recorded at the intervals set with **[Position update intvl]** (p.226). The log data is saved in the camera's internal memory by date. The table below shows how many days' worth of data can be saved.

### Log Data Capacity by Positioning Interval

(Approx.)

Update Interval	Log Data	Update Interval	Log Data
Every 1 sec.	4.1 days	Every 30 sec.	100 days
Every 5 sec.	20 days	Every 1 min.	100 days
Every 10 sec.	41 days	Every 2 min.	100 days
Every 15 sec.	61 days	Every 5 min.	100 days

\* When recording eight hours of log data per day.

- The log data saved in the internal memory can be transferred as a log file to a card (p.230).
- Log file names consist of the date and number (e.g. 17051800). A log file is created for each day. If the time zone changes (p.49), a new log file will be created.
- If the camera's internal memory becomes full, the oldest log data will be erased, and the newest log data will be saved.

## Battery Consumption During Logging

When **[GPS]** is set to **[Mode 1]**, the camera will continue to receive GPS signals at regular intervals even after the camera's power switch is set to **<OFF>**. If **[Mode 2]** is set, the camera will continue to receive GPS signals at regular intervals even during auto power off. The battery will thereby drain faster and the number of possible shots will decrease. Additionally, when **[Log GPS position]** is set to **[Enable]**, shorter update intervals will drain the battery more quickly.

When you are not traveling or when GPS signals are weak, setting **[GPS]** to **[Disable]** is recommended.

## Downloading Log Data to a Computer

The log data in the camera's internal memory can be downloaded to a computer with EOS Utility (EOS software, p.594) or downloaded from a card after transferring the data to the card.

### ● Transferring the log data to a card for downloading

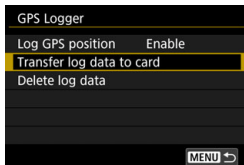

- When [**Transfer log data to card**] is selected, you can transfer the log data in the internal memory as log files to a card.

Note that when log files are transferred to a card, that log data is erased from the camera's internal memory.

- The log files imported to the card will be stored in the "GPS" folder in the "MISC" folder. The extension is ".LOG".
- Selecting [**Delete log data**] will erase the log data saved in the internal memory. Erasing the data may take approx. one minute.
- **Importing the log data using EOS software**

With the camera connected to a computer with an interface cable (sold separately), you can download the log data to the computer with EOS Utility (EOS software). For details, refer to the EOS Utility Instruction Manual (p.596).



- The GPS antenna is located at the top of the camera body. For this reason, even when carrying the camera, such as in a bag, try to keep the top of the camera facing upwards, and do not place anything on top of it.
- Set the camera time and date as accurately as possible. Also, set correct time zone and daylight saving time for the shooting location.



# 6

## Advanced Operations for Photographic Effects

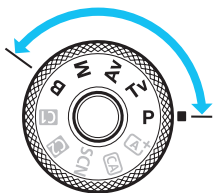

In Creative Zone modes, you can change various settings of the camera as you desire to obtain a wide variety of shooting results, by selecting the shutter speed and/or aperture, adjusting the exposure as you prefer, etc.

- The ☆ icon at the upper right of the page title indicates that the function is available only in Creative Zone modes (<P>, <Tv>, <Av>, <M>, <B>).
- After you press the shutter button halfway and let go, the exposure settings will remain displayed in the viewfinder and on the LCD panel for approx. 4 sec. (⌚4) by the metering timer function.
- For the functions settable in each shooting mode, see page 526.



Set the <LOCK> switch downward.

# P: Program AE

The camera automatically sets the shutter speed and aperture to suit the subject's brightness. This is called Program AE.

\* <P> stands for Program.

\* AE stands for Auto Exposure.



## 1 Set the Mode Dial to <P>.



## 2 Focus on the subject.

- Look through the viewfinder and aim the AF point over the subject. Then press the shutter button halfway.
- ▶ When focus is achieved, the focus indicator <●> in the viewfinder will light up (in One-Shot AF mode).
- ▶ The shutter speed and aperture will be set automatically and displayed in the viewfinder and on the LCD panel.



## 3 Check the display.

- The standard exposure will be obtained as long as the shutter speed and aperture displays do not blink.

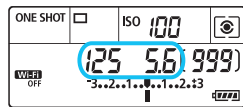

## 4 Take the picture.

- Compose the shot and press the shutter button completely.

If a description of the shooting mode appears on the LCD monitor when you do step 1, press <SET> to hide it (p.89).



- If the “30'” shutter speed and the lowest f/number blink, it indicates underexposure. Increase the ISO speed or use flash.



- If the “4000” shutter speed and the highest f/number blink, it indicates overexposure. Lower the ISO speed or use an ND filter (sold separately) to reduce the amount of light entering the lens.



### Differences Between <P> and <A+> Modes

In the <A+> mode, many functions, such as the AF operation and metering mode, are set automatically to prevent spoiled shots. The functions you can set are limited. On the other hand, with <P> mode, only the shutter speed and aperture are set automatically. You can freely set the AF operation, metering mode, and other functions (p.526).

### Program Shift

- In the Program AE mode, you can freely change the shutter speed and aperture combination (Program) set automatically by the camera while maintaining the same exposure. This is called Program shift.
- To shift the program, press the shutter button halfway, then turn the <A+> dial until the desired shutter speed or aperture is displayed.
- Program shift will be canceled automatically when the metering timer (4) ends (exposure setting display turns off).
- Program shift cannot be used with flash.

# Tv: Shutter-Priority AE

In this mode, you set the shutter speed and the camera automatically sets the aperture to obtain the standard exposure matching the brightness of the subject. This is called shutter-priority AE. A faster shutter speed can freeze the action of a moving subject. A slower shutter speed can create a blurred effect, giving the impression of motion.

\* <Tv> stands for Time value.

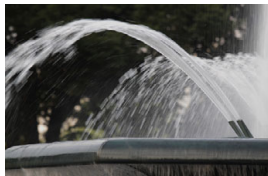

Blurred motion  
(Slow shutter speed: 1/30 sec.)



Frozen motion  
(Fast shutter speed: 1/2000 sec.)



## 1 Set the Mode Dial to <Tv>.

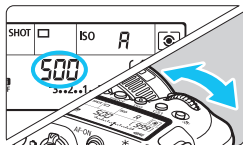

## 2 Set the desired shutter speed.

- While looking at the LCD panel or viewfinder, turn the <  > dial.

## 3 Focus on the subject.

- Press the shutter button halfway.
- ▶ The aperture is set automatically.



## 4 Check the viewfinder display and shoot.

- As long as the aperture is not blinking, the standard exposure will be obtained.





- If the lowest f/number blinks, it indicates underexposure. Turn the  dial to set a slower shutter speed until the aperture stops blinking or set a higher ISO speed.



- If the highest f/number blinks, it indicates overexposure. Turn the  dial to set a faster shutter speed until the aperture stops blinking or set a lower ISO speed.



### Shutter Speed Display

The shutter speeds from “4000” to “4” indicate the denominator of the fractional shutter speed. For example, “125” indicates 1/125 sec., “0”5” indicates 0.5 sec., and “15” is 15 sec.

## Av: Aperture-Priority AE

In this mode, you set the desired aperture and the camera sets the shutter speed automatically to obtain the standard exposure matching the subject brightness. This is called aperture-priority AE. A higher f/number (smaller aperture hole) will make more of the foreground and background fall within acceptable focus. On the other hand, a lower f/number (larger aperture hole) will make less of the foreground and background fall within acceptable focus.

\* <Av> stands for Aperture value (aperture opening).



Blurred background  
(With a low aperture f/number: f/5.6)



Sharp foreground and background  
(With a high aperture f/number: f/32)



1 Set the Mode Dial to <Av>.

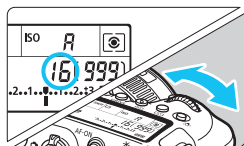

2 Set the desired aperture.

- While looking at the LCD panel or viewfinder, turn the < > dial.

3 Focus on the subject.

- Press the shutter button halfway.
- ▶ The shutter speed is set automatically.



4 Check the viewfinder display and shoot.

- As long as the shutter speed is not blinking, the standard exposure will be obtained.



- If the “30” shutter speed blinks, it indicates underexposure. Turn the <img alt="Shutter speed dial icon" data-bbox="458 151 501 168"/> dial to set a larger aperture (lower f/ number) until the shutter speed blinking stops or set a higher ISO speed.



- If the “4000” shutter speed blinks, it indicates overexposure. Turn the <img alt="Shutter speed dial icon" data-bbox="458 272 501 289"/> dial to set a smaller aperture (higher f/ number) until the shutter speed blinking stops or set a lower ISO speed.



### Aperture Value Display

The higher the f/number, the smaller the aperture opening will be. The f/number displayed varies depending on the lens. If no lens is attached to the camera, “00” will be displayed for the aperture.

## Depth-of-Field Preview ☆

The aperture opening (diaphragm) changes only at the moment when the picture is taken. Otherwise, the aperture remains fully open. Therefore, when you look at the scene through the viewfinder or on the LCD monitor, the depth of field will look narrow (shallow).

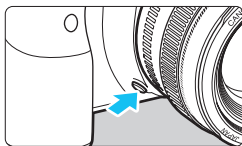

Press the depth-of-field preview button to stop down the lens to the current aperture setting and check the depth of field (range of acceptable focus).

With an external Speedlite, pressing the camera's depth-of-field preview button will fire a modeling flash. (Depth-of-field preview will not work.)

- A higher f/number will make more of the foreground and background fall within acceptable focus. However, the viewfinder will look darker.
- The depth-of-field effect can be clearly seen on the Live View image as you change the aperture and press the depth-of-field preview button (p.290).
- The exposure will be locked (AE lock) while the depth-of-field preview button is being pressed.

# M: Manual Exposure

In this mode, you set both the shutter speed and aperture as desired. To determine the exposure, refer to the exposure level indicator in the viewfinder or use a commercially-available exposure meter. This method is called manual exposure.





\* <M> stands for Manual.



1 Set the Mode Dial to <M>.

2 Set the ISO speed (p.170).

3 Set the shutter speed and aperture.

- To set the shutter speed, turn the <  > dial. To set the aperture, turn the <  > dial.
- If it cannot be set, set the <LOCK> switch downward, then turn the <  > or <  > dial.

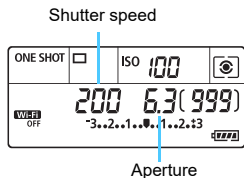

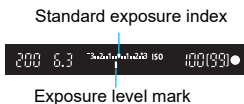

4 Focus on the subject.

- Press the shutter button halfway.
- ▶ The exposure setting will be displayed in the viewfinder and on the LCD panel.
- Check the exposure level mark <  > to see how far the current exposure level is from the standard exposure level.



5 Set the exposure and take the picture.

- Check the exposure level indicator and set the desired shutter speed and aperture.
- If the exposure level exceeds  $\pm 3$  stops from the standard exposure, the end of the exposure level indicator will display <  > or <  >.

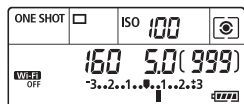

## Exposure Compensation with ISO Auto

If the ISO speed is set to **A** (AUTO) for manual exposure shooting, you can set exposure compensation (p.245) as follows:

- [ **2: Expo.comp./AEB**]
- Under [ **C.Fn III-4: Custom Controls**], with [ **Expo comp (hold btn, turn sun)**] (p.502).
- Quick Control (p.61)

- If ISO Auto is set, the ISO speed setting will change to obtain the standard exposure with the set shutter speed and aperture. Therefore, you may not obtain the desired exposure effect. In such a case, set the exposure compensation.
- The set exposure value will not be applied to movie shooting.

- Under [ **2: Auto Lighting Optimizer**], if the checkmark [] for [**Disabled in M or B modes**] is removed, Auto Lighting Optimizer can be set even in the <M> mode (p.194).
- With the camera set to the <M> mode + ISO Auto + <[]> (Evaluative metering) and [ **C.Fn I-8: Meter. mode, AE locked after focus**] set to the default setting (p.474), holding down the shutter button halfway will lock the ISO speed after focus is achieved with One-Shot AF.
- When ISO Auto is set, you can press the <[]> button to lock the ISO speed.
- If you press the <[]> button and recompose the shot, you can see the exposure level difference on the exposure level indicator compared to when the <[]> button was pressed.
- If exposure compensation (p.245) was applied in <P>, <Tv>, or <Av> mode, the exposure compensation amount already set will still be maintained when the shooting mode is switched to <M> with ISO Auto set.
- With ISO Auto set and [ **C.Fn I-1: Exposure level increments**] set to [**1/2-stop**], any 1/2-stop exposure compensation will be implemented with the ISO speed (1/3 stop) and shutter speed. However, the shutter speed displayed will not change.

## Selecting the Metering Mode <sup>☆</sup>

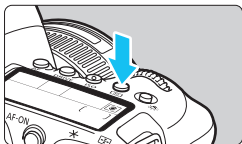

You can select one of four methods to measure the subject brightness. In Basic Zone modes, evaluative metering is set automatically. (In the <SCN:  > mode, center-weighted average metering is set automatically.)



**1** Press the < > button (6).



**2** Select the metering mode.

- While looking at the LCD panel or the viewfinder, turn the < > or < > dial.

: **Evaluative metering**

: **Partial metering**

: **Spot metering**

: **Center-weighted average metering**

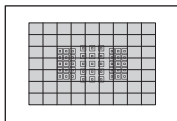

: **Evaluative metering**

General-purpose metering mode suited even for backlit subjects. The camera adjusts the exposure automatically to suit the scene.



: **Partial metering**

Effective where there are much brighter lights around the subject due to backlight, etc. Partial metering covers approx. 6.5% of the viewfinder area at the center.

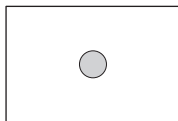







 **Spot metering**

Effective when metering a specific part of the subject or scene. Spot metering covers approx. 3.2% of the viewfinder area at the center. The spot metering circle will be displayed in the viewfinder.



 **Center-weighted average metering**

The metering is averaged for the entire scene with the viewfinder center weighted more heavily.

-  ● By default, the camera will set the exposure as follows. With  (Evaluative metering), holding down the shutter button halfway will lock the exposure setting (AE lock) after focus is achieved with One-Shot AF. In the  (Partial metering),  (Spot metering), and  (Center-weighted average metering) modes, the exposure is set at the moment the picture is taken. (Pressing the shutter button halfway does not lock the exposure.)
- With [ **C.Fn I-8: Meter. mode, AE locked after focus**], you can set whether or not to lock the exposure (AE lock) when focus is achieved with One-Shot AF (p.474).



## ☑ Setting the Desired Exposure Compensation ☆

Exposure compensation can brighten (increased exposure) or darken (decreased exposure) the standard exposure set by the camera. Exposure compensation can be set in the <P>, <Tv>, and <Av> shooting modes. Although you can set the exposure compensation up to  $\pm 5$  stops in 1/3-stop increments for viewfinder shooting, the exposure compensation indicator in the viewfinder and on the LCD panel can display the setting only up to  $\pm 3$  stops. If you want to set the exposure compensation setting beyond  $\pm 3$  stops, use the Quick Control (p.61) or follow the instructions for [📷2: Expo.comp./AEB] on page 247. If the <M> mode and ISO Auto are both set, see page 242 to set the exposure compensation.

### 1 Check the exposure.

- Press the shutter button halfway (📷4) and check the exposure level indicator.

Increased exposure for a brighter image



Decreased exposure for a darker image



### 2 Set the compensation amount.

- While looking at the viewfinder or LCD panel, turn the <📷> dial.
- If it cannot be set, set the <LOCK> switch downward, then turn the <📷> dial.
- ▶ For exposure compensation, the <☑> icon will be displayed in the viewfinder and on the LCD panel.

### 3 Take the picture.

- To cancel exposure compensation, set the exposure level indicator <📷> to the standard exposure index (<📷>).

- For Live View and movie shooting, the exposure compensation can be set only up to  $\pm 3$  stops.
- If [**2: Auto Lighting Optimizer**] (p.194) is set to any setting other than [**Disable**], the image may still look bright even if a decreased exposure compensation for a darker image is set.
- The set exposure compensation amount will not be applied to movie shooting.

- The exposure compensation amount will remain in effect even after you set the power switch to <OFF>.
- After setting the exposure compensation amount, you can set the <LOCK> switch upward to prevent the exposure compensation amount from changing inadvertently.
- If the exposure compensation amount exceeds  $\pm 3$  stops, the end of the exposure level indicator will display <◀> or <▶>.
- With [**C.Fn I-7: Exposure comp. auto cancel**], you can set whether to cancel the exposure compensation setting when the power switch is set to <OFF> (p.474).

# Auto Exposure Bracketing (AEB) ☆

By changing the shutter speed, aperture, or ISO speed automatically, you can bracket the exposure up to  $\pm 3$  stops in 1/3-stop increments for three consecutive shots. This is called AEB.

\* AEB stands for Auto Exposure Bracketing.

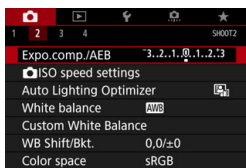

## 1 Select [Expo.comp./AEB].

- Under the [CAMERA] tab, select [Expo.comp./AEB], then press <SET>.

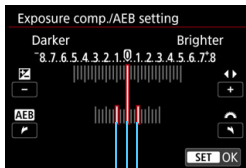

AEB range

## 2 Set the AEB range.

- Turn the <WHEEL> dial to set the AEB range. By pressing the <◀> <▶> keys, you can set the exposure compensation amount.
- Press <SET> to set it.
- When you exit the menu, the AEB range will be displayed on the LCD panel.

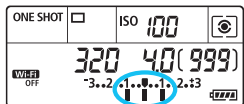

## 3 Take the picture.

- Three bracketed shots will be taken according to the drive mode set in this sequence: Standard exposure, decreased exposure, and increased exposure.
- AEB will not be automatically canceled. To cancel AEB, follow step 2 to turn off the AEB range display.

Standard exposure





Decreased exposure



Increased exposure



 If [**2: Auto Lighting Optimizer**] (p.194) is set to any setting other than [**Disable**], the effect of AEB may be reduced.

- 
- During AEB shooting, <✳> will blink in the viewfinder.
  - If the drive mode is set to <□> or <□S>, press the shutter button three times for each shot. When <□H>, <□>, or <□S> is set and you hold down the shutter button completely, the three bracketed shots will be taken consecutively and the camera will automatically stop shooting. When <□> or <□2> is set, the three bracketed shots will be taken consecutively after a 10-sec. or 2-sec. delay. When <□C> is set, the three bracketed shots multiplied by the number of shots set with [**Self-timer: Continuous**] will be taken consecutively after a 10-sec. delay.
  - You can set AEB in combination with exposure compensation.
  - If the AEB range exceeds ±3 stops, the end of the exposure level indicator will display <◀> or <▶>.
  - AEB cannot be used with flash, bulb exposures, or when Multi Shot Noise Reduction or HDR Mode is set.
  - AEB will be canceled automatically if you do any of the following: Setting the power switch to <OFF>, switching to movie shooting, or when the flash is fully charged.

## ✳ Locking the Exposure for Shooting (AE Lock) ☆

You can lock the exposure when you want to set the focus and exposure separately or when you are to take multiple shots at the same exposure setting. Press the <✳> button to lock the exposure, then recompose and take the picture. This is called AE lock. It is effective for shooting backlit subjects, etc.

### 1 Focus on the subject.

- Press the shutter button halfway.
- ▶ The exposure setting will be displayed.

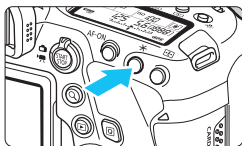

### 2 Press the <✳> button (Ⓢ4).

- ▶ The <✳> icon lights up in the viewfinder to indicate that the exposure setting is locked (AE lock).
- Each time you press the <✳> button, the current exposure setting is locked.



### 3 Recompose and take the picture.

- When you are to take more pictures while maintaining the AE lock, keep holding down the <✳> button and press the shutter button to take another picture.

## AE Lock Effects

Metering Mode (p.243)	AF Point Selection Method (p.136, 137)	
	Automatic Selection	Manual Selection
	AE lock is applied at the AF point that achieved focus.	AE lock is applied at the selected AF point.
	AE lock is applied at the center AF point.	

\* When the <☉> mode is set and the lens's focus mode switch is set to <MF>, AE lock is applied with the exposure weighted on the center AF point.

AE lock is not possible with bulb exposures.

## B: Long (Bulb) Exposures

In this mode, the shutter stays open as long as you hold down the shutter button completely, and closes when you let go of the shutter button. This photographic technique is called “bulb exposure”. Use bulb exposures for night scenes, fireworks, the heavens, and other subjects requiring long exposures.



### 1 Set the Mode Dial to <B>.

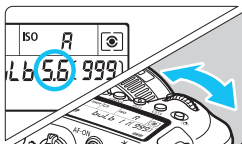

### 2 Set the desired aperture.

- While looking at the LCD panel or the viewfinder, turn the <☀> or <☾> dial.

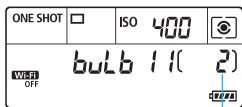

### 3 Take the picture.

- The exposure will continue for as long as you keep the shutter button pressed completely.
- ▶ The elapsed exposure time will be displayed on the LCD panel.

Elapsed exposure time

- ⚠ Do not point the camera toward an intense light source, such as the sun or an intense artificial light source. Doing so may damage the image sensor or the camera's internal components.
- Long bulb exposures produce more noise in the image than usual.
- If ISO Auto is set, ISO 400 will be set (p.172).
- When shooting bulb exposures without using the bulb timer, if you use both the self-timer and mirror lockup, keep pressing the shutter button completely (for self-timer delay time + bulb exposure time). If you let go of the shutter button during the self-timer countdown, there will be a shutter-release sound, but no picture will be taken. If you use the bulb timer under the same shooting conditions, you need not keep holding down the shutter button completely.



- With [**3: Long exp. noise reduction**], you can reduce the noise generated during long exposures (p.197).
- For bulb exposures, using a tripod and bulb timer is recommended. You can also use mirror lockup (p.265) in combination.
- You can also shoot bulb exposures by using Remote Switch RS-80N3 (sold separately) or Timer Remote Controller TC-80N3 (sold separately, p.276).
- You can also use Remote Controller RC-6 (sold separately, p.271) or Wireless Remote Control BR-E1 (sold separately, p.273) for bulb exposures. When you press the remote controller's transmit button, the bulb exposure will start immediately or 2 sec. later. Press the button again to stop the bulb exposure.

## TIMER Bulb Timer ☆

You can preset the bulb exposure's exposure time. With the bulb timer, you need not keep holding down the shutter button during the bulb exposure. This reduces camera shake.

The bulb timer can be set only in the <**B**> (bulb exposure). It cannot be set (or will not function) in any other mode.

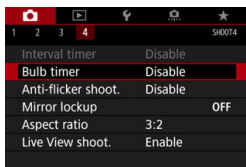

### 1 Select [**Bulb timer**].

- Under the [**4**] tab, select [**Bulb timer**], then press <SET>.

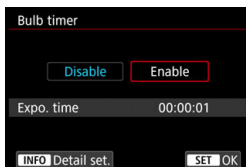

### 2 Select [**Enable**].

- Select [**Enable**], then press the <INFO> button.

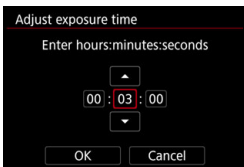

### 3 Set the desired exposure time.

- Select the hour, minute, or second.
- Press  $\langle \text{SET} \rangle$  so  $\langle \uparrow \rangle$  is displayed.
- Set the desired number, then press  $\langle \text{SET} \rangle$ . (Returns to  $\langle \square \rangle$ .)

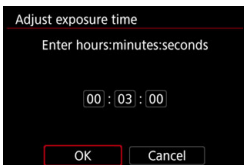

### 4 Select [OK].

- ▶ The set time will be displayed on the menu screen.
- ▶ When you exit the menu,  $\langle \text{TIMER} \rangle$  will be displayed on the LCD panel.

Elapsed exposure time

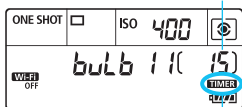

Bulb timer

### 5 Take the picture.

- ▶ Press the shutter button completely, and the bulb exposure will start and continue until the set time elapses.
- During bulb timer shooting,  $\langle \text{TIMER} \rangle$  will blink.
- To cancel the timer setting, set **[Disable]** in step 2.

- While the bulb timer is operating, if you press the shutter button completely and let go of it, the bulb exposure will stop.
- If you keep pressing the shutter button completely after the exposure starts, the bulb exposure will continue even after the set exposure time elapses. (The bulb exposure will not stop automatically when the set exposure time elapses.)
- If the drive mode is set to  $\langle \text{C} \rangle$  (Self-timer: Continuous), the bulb timer cannot be set.
- Doing any of the following will cancel the bulb timer (reverts to **[Disable]**): Setting the power switch to  $\langle \text{OFF} \rangle$ , replacing the battery, replacing the card, switching to movie shooting, or changing the shooting mode to a mode other than  $\langle \text{B} \rangle$ .



# HDR: HDR (High Dynamic Range) Shooting ☆

You can shoot still photos with clipped highlights and shadows reduced for a high dynamic range of tones even in high-contrast scenes. HDR shooting is effective for landscape and still-life shots.

**With HDR shooting, three images of different exposures (standard exposure, underexposure, and overexposure) are captured consecutively for each shot and then merged together automatically. The HDR image is recorded as a JPEG image.**

\* HDR stands for High Dynamic Range.

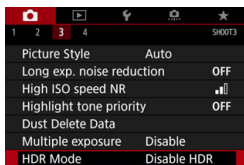

## 1 Select [HDR Mode].

- Under the [**3**] tab, select [**HDR Mode**], then press < (SET) >.

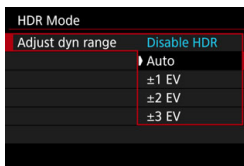

## 2 Set [Adjust dyn range].

- Select the desired dynamic range setting, then press < (SET) >.
- Selecting [**Auto**] will have the dynamic range set automatically depending on the image's overall tonal range.
- The higher the number, the wider the dynamic range will be.
- To exit HDR shooting, select [**Disable HDR**].

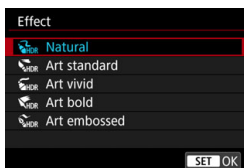

## 3 Set [Effect].

- Select the desired effect, then press < (SET) >.

## Effects

-  **Natural**

For images preserving a wide tonal range where the highlight and shadow details would otherwise be lost. Clipped highlights and shadows will be reduced.

-  **Art standard**

While the clipped highlights and shadows will be reduced more than with **[Natural]**, the contrast will be lower, and the gradation flatter to have the picture look like a painting. The subject outlines will have bright (or dark) edges.

-  **Art vivid**

The colors are more saturated than with **[Art standard]**, and the low contrast and flat gradation create a graphic art effect.

-  **Art bold**

The colors are the most saturated, making the subject pop out, and the picture looks like an oil painting.

-  **Art embossed**

The color saturation, brightness, contrast and gradation are decreased to make the picture look flat. The picture looks faded and old. The subject outlines will have bright (or dark) edges.

	Art standard	Art vivid	Art bold	Art embossed
Saturation	Standard	High	Higher	Low
Outline emphasis	Standard	Weak	Strong	Stronger
Brightness	Standard	Standard	Standard	Dark
Tone	Flat	Flat	Flat	Flatter

 Each effect will be applied based on the characteristics of the Picture Style currently set (p.176).

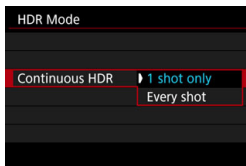

#### 4 Set [Continuous HDR].

- Select either [**1 shot only**] or [**Every shot**], then press < (SET) >.
- With [**1 shot only**], HDR shooting will be canceled automatically after the shooting ends.
- With [**Every shot**], HDR shooting continues until the setting in step 2 is set to [**Disable HDR**].

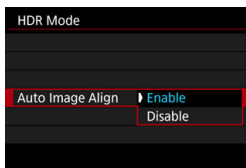

#### 5 Set [Auto Image Align].

- For handheld shooting, select [**Enable**]. When using a tripod, select [**Disable**], then press < (SET) >.

#### 6 Take the picture.

- HDR shooting is possible with viewfinder shooting and Live View shooting.
- When you press the shutter button completely, three consecutive images will be captured, and the HDR image will be recorded to the card.

- You cannot select RAW or RAW+JPEG image quality. The HDR mode cannot be set if RAW or RAW+JPEG is set.
- HDR shooting is not possible with expanded ISO speeds (L, H1, H2). HDR shooting is possible within ISO 100 - ISO 40000 (varies depending on the settings of [Minimum] and [Maximum] for [ISO speed range]).
- The flash will not fire during HDR shooting.
- HDR shooting will automatically have the following set to [Disable]: [Distortion correction] under [📷1: Lens aberration correction], [📷2: Auto Lighting Optimizer], and [📷3: Highlight tone priority].
- AEB cannot be set.
- If you shoot a moving subject, the moving subject may leave afterimages.
- In HDR shooting, 3 images are captured with different shutter speeds set automatically. Therefore, even in the <Tv> and <M> shooting modes, the shutter speed will be shifted based on the shutter speed you set.
- To prevent camera shake, a high ISO speed may be set.
- You can set the camera to display <📷> in the viewfinder and on the LCD panel for when the HDR mode is set (p.489).



- When shooting HDR images with **[Auto Image Align]** set to **[Enable]**, AF point display information (p.397) and Dust Delete Data (p.452) will not be appended to the image.
- If you perform handheld HDR shooting with **[Auto Image Align]** set to **[Enable]**, image periphery will be slightly trimmed and resolution will be slightly lowered. Also, if the images cannot be aligned properly due to camera shake, etc., auto image alignment may not take effect. Note that when shooting with excessively bright (or dark) exposure settings, auto image alignment may not work properly.
- If you perform handheld HDR shooting with **[Auto Image Align]** set to **[Disable]**, the 3 images may not be properly aligned and the HDR effect may be reduced. Using a tripod is recommended.
- Auto image alignment may not function properly with repetitive patterns (lattice, stripes, etc.) or flat, single-tone images.
- The color gradation of the sky or white walls may not be reproduced correctly. Irregular colors, irregular exposure or noise may appear.
- HDR shooting under fluorescent or LED lighting may result in unnatural color reproduction of the illuminated areas.
- With HDR shooting, the images will be merged, then saved to the card, so it may take some time. During the processing of the images, “**buSY**” will be displayed in the viewfinder and on the LCD panel, and you cannot take another picture until the processing is complete.
- If you set HDR shooting and then switch to movie shooting, the HDR shooting setting may be canceled (the **[Adjust dyn range]** setting may be changed to **[Disable HDR]**).

# Multiple Exposures ☆

You can shoot two to nine exposures to be merged into one image. With Live View shooting (p.289), you can see in real time how the exposures are merged when you shoot multiple-exposure images.

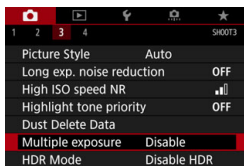

## 1 Select [Multiple exposure].

- Under the [CAMERA 3] tab, select [Multiple exposure], then press <SET>.

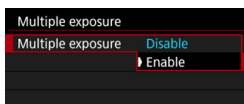

## 2 Set [Multiple exposure].

- Select [Enable], then press <SET>.
- To exit shooting multiple exposures, select [Disable].



## 3 Set [Multi-expos ctrl].

- Select the desired multiple-exposure control method, then press <SET>.

### • Additive

The exposure of each single image captured is added cumulatively. Based on the [No. of exposures], set a negative exposure compensation. Follow the basic guide below to set the exposure compensation amount.

### Exposure Compensation Setting Guide by Number of Exposures

Two exposures: -1 stop, three exposures: -1.5 stop, four exposures: -2 stops

### • Average

Based on the [No. of exposures], negative exposure compensation is set automatically as you shoot multiple exposures. If you shoot multiple exposures of the same scene, the exposure of the subject's background will be automatically controlled to obtain the standard exposure.



#### 4 Set the [No. of exposures].

- Select the number of exposures, then press <SET>.
- You can set it from 2 to 9 exposures.

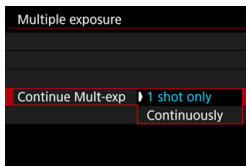

#### 5 Set [Continue Mult-exp].

- Select either [1 shot only] or [Continuously], then press <SET>.
- With [1 shot only], multiple-exposure shooting will be canceled automatically after the shooting ends.
- With [Continuously], multiple-exposure shooting continues until the setting in step 2 is set to [Disable].



Remaining number of exposures

#### 6 Shoot the first exposure.

- ▶ The captured image will be displayed.
- ▶ The <[ ]> icon will blink.
- You can check the remaining exposures in brackets [ ] displayed in the viewfinder or on the screen.
- Pressing the <[ ]> button enables you to view the captured image (p.263).

## 7 Shoot subsequent exposures.

- ▶ The captured image combining the multiple exposures will be displayed.
- When you perform Live View shooting, the multiple-exposure images merged so far will be displayed. By pressing the <INFO> button, you can display only the Live View image.
- Multiple-exposure shooting will end when the set number of exposures are taken. With continuous shooting, if you keep holding down the shutter button, the shooting will stop after the set number of exposures are taken.

- While shooting, you can press the <▶> button to check the multiple-exposure image created so far or delete the last single exposure (p.263).
- The shooting information for the last shot will be recorded and appended to the multiple-exposure image.

- Only the multiple-exposure image will be saved. The multiple exposures taken in steps 6 and 7 will not be saved.
- During continuous shooting, the continuous shooting speed will decrease greatly.
- The image-recording quality, ISO speed, Picture Style, high ISO speed noise reduction, color space, etc. set for the first single exposure will also be set for the subsequent exposures.
- You cannot set an aspect ratio for multiple-exposure shooting. Pictures will be taken with a 3:2 aspect ratio.





- For multiple-exposure shooting, the settings will be automatically switched to **[Disable]** for the following: all the items of **[📷1: Lens aberration correction]**, **[📷2: Auto Lighting Optimizer]**, and **[📷3: Highlight tone priority]**.
- If **[📷3: Picture Style]** is set to **[Auto]**, **[Standard]** will be applied for shooting.
- With **[Additive]** set, the noise, irregular colors, banding, etc. of the image displayed during shooting may look different from the multiple-exposure image recorded in the end.
- With multiple exposures, the more exposures there are, the more noticeable the noise, irregular colors, and banding will be.
- If **[Additive]** is set, the image processing after taking the multiple exposures will take time. (The access lamp will light up longer.)
- If you perform Live View shooting with **[Additive]** set, the Live View function will stop automatically when the multiple-exposure shooting ends.
- If the number of multiple exposures is less than the number of continuous shots set with <🕒> (Self-timer: Continuous), the multiple exposure shooting will end after the number of exposures set with **[No. of exposures]** is taken.
- In step 7, the brightness and noise of the multiple-exposure image displayed during Live View shooting will be different from those of the final multiple-exposure image recorded.
- Doing any of the following will cancel the multiple-exposure shooting: Setting the power switch to <OFF>, replacing the battery, replacing the card, or switching to movie shooting.
- During multiple-exposure shooting, **[Clean now 🧼]** or **[Clean manually]** under **[🔧4: Sensor cleaning]** cannot be selected.
- While shooting, if you switch to a Basic Zone mode or to <📷1> or <📷2>, the multiple-exposure shooting will end.
- If you connect the camera to a computer, multiple-exposure shooting will not be possible. If you connect the camera to a computer during shooting, multiple-exposure shooting will end.

## Merging Multiple Exposures with an Image Recorded on the Card

You can select a **RAW** image recorded on the card as the first single exposure. The image data of the selected **RAW** image will remain intact. **You can only select RAW images.** You cannot select **M RAW/S RAW** or JPEG images.



### 1 Select [Select image for multi. expo.].

- ▶ The images on the card will be displayed.

### 2 Select the first image.

- Turn the  $\langle \odot \rangle$  dial to select the image to be used as the first single exposure, then press  $\langle \text{SET} \rangle$ .
- Select **[OK]**.
- ▶ The file number of the selected image will be displayed at the bottom of the screen.

### 3 Take the picture.

- When you select the first image, the number of remaining exposures as set with **[No. of exposures]** will decrease by 1. For example, if **[No. of exposures]** is 3, you can shoot two exposures.

- The following cannot be selected as the first single exposure: Images shot with **[📷3: Highlight tone priority]** set to **[Enable]** or images with **[📷4: Aspect ratio]** not set to **[3:2]** (p.168).
- **[Disable]** will be applied for **[📷1: Lens aberration correction]** and **[📷2: Auto Lighting Optimizer]** regardless of the settings of the **RAW** image selected as the first single exposure.
- The ISO speed, Picture Style, high ISO speed noise reduction, color space, etc. set for the first **RAW** image will also be applied for the subsequent images.
- If Picture Style is **[Auto]** for the **RAW** image selected as the first **RAW** image, **[Standard]** will be applied for shooting.
- You cannot select an image taken with another camera.



- You can also select a **RAW** multiple-exposure image as the first single exposure.
- If you select [**Deselect img**], the image selection for the first image will be canceled.

## Checking and Deleting Multiple Exposures During Shooting

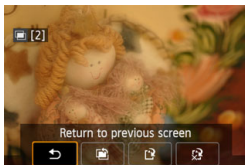

Before you finish shooting the set number of exposures, you can press the <▶> button to check the current exposure level, overlap alignment, and overall effect of the merged multiple-exposure image.

Pressing the <🗑> button will display the operations possible during multiple-exposure shooting.

Operation	Description
↶ Return to previous screen	The screen before you pressed the <🗑> button will reappear.
🗑 Undo last image	Deletes the last image you shot (shoot another image). The number of remaining exposures will increase by 1.
📄 Save and exit	The image shot so far will be saved as a multiple-exposure image and the multiple-exposure shooting will end.
🗑 Exit without saving	The multiple-exposure shooting will end without saving the image.



During multiple-exposure shooting, you can only play back multiple-exposure images.

## ? FAQ

### ● Are there any restrictions on the image-recording quality?

All JPEG image-recording quality settings can be selected. If **M RAW** or **S RAW** is set, the merged multiple-exposure image will be saved as a **RAW** image.

Image Quality Setting	Merged Multiple-Exposure
JPEG	JPEG
<b>RAW</b>	<b>RAW</b>
<b>M RAW / S RAW</b>	<b>RAW</b>
<b>RAW +JPEG</b>	<b>RAW +JPEG</b>
<b>M RAW / S RAW +JPEG</b>	<b>RAW +JPEG</b>

### ● Can I merge images recorded on the card?

With [**Select image for multi. expo.**], you can select the first single exposure from the images recorded on the card (p.262). Note that you cannot merge multiple images already recorded on the card.

### ● Are multiple exposures possible with Live View shooting?

You can shoot multiple exposures with Live View shooting (p.289).

### ● Will auto power off take effect during multiple-exposure shooting?

As long as [**2: Auto power off**] is set to any setting other than [**Disable**], the power will turn off automatically after approx. 30 min. If the auto power off takes effect, multiple-exposure shooting will end, and multiple-exposure settings will be canceled.

Before starting the multiple-exposure shooting, the auto power off will take effect at the time set with the camera, and multiple-exposure settings will be canceled.

# Mirror Lockup <sup>☆</sup>

Camera vibrations caused by the mirror's reflex action when the picture is taken is called "mirror shock". Mirror lockup keeps the mirror up before and during exposure to reduce blur caused by camera vibrations. Useful when shooting close-ups (macro photography), using a super telephoto lens, shooting at slow shutter speeds, etc.

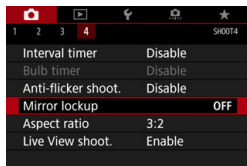

## 1 Select [Mirror lockup].

- Under the [4] tab, select [Mirror lockup], then press <SET>.

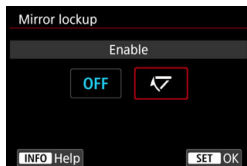

## 2 Select [Enable].

## 3 Focus on the subject, then press the shutter button completely.

- ▶ The mirror will swing up.

## 4 Press the shutter button completely again.

- The picture is taken and the mirror goes back down.

-  Do not point the camera toward an intense light source, such as the sun or an intense artificial light source. Doing so may damage the image sensor or the camera's internal components.
- In very bright light, such as at the beach or a ski slope on a sunny day, take the picture promptly after mirror lockup is stabilized.
- During mirror lockup, shooting function settings and menu operations are disabled.

-  When **[Enable]** is set, single shooting will take effect even if the drive mode is set to continuous.
- You can also use the self-timer with mirror lockup.
- If approx. 30 sec. elapse after the mirror has locked up, it will go back down automatically. Pressing the shutter button completely locks up the mirror again.
- When shooting with mirror lockup, using a tripod and Remote Switch RS-80N3 (sold separately) or Timer Remote Controller TC-80N3 (sold separately) is recommended (p.276).
- You can also use Remote Controller RC-6 (sold separately, p.271) or Wireless Remote Control BR-E1 (sold separately, p.273) with mirror lockup. Setting the remote controller to a 2-sec. delay is recommended.

## TIMER Interval Timer Shooting

With the interval timer, you can set the shooting interval and the number of shots. The camera will repeat taking one shot with the set interval until the set number of shots are taken.

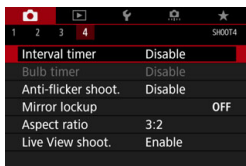

### 1 Select [Interval timer].

- Under the [**4**] tab (the [**1**] tab in Basic Zone modes), select [**Interval timer**], then press <SET>.

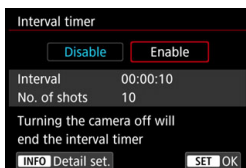

### 2 Select [Enable].

- Select [**Enable**], then press the <INFO> button.

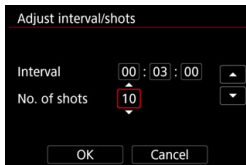

### 3 Set the shooting interval and number of shots.

- Select the item to be set (hours: minutes: seconds / number of shots).
- Press <SET> so <↑> is displayed.
- Set the desired number, then press <SET>. (Returns to <□>.)

- **Interval**

Settable in the range from [00:00:01] to [99:59:59].

- **Number of shots**

Settable in the range from [01] to [99]. If you set [00], the camera will keep shooting an unlimited number of shots until you stop the interval timer shooting.

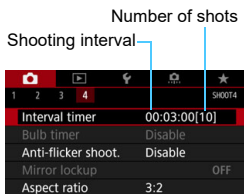

#### 4 Select [OK].

- ▶ The interval timer settings will be displayed on the menu screen.
- ▶ When you exit the menu, < **TIMER** > will be displayed on the LCD panel.

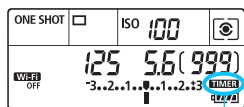

#### 5 Take the picture.

- ▶ First shot is taken and shooting continues according to the interval timer settings.
- During interval timer shooting, < **TIMER** > will blink.
- After the set number of shots are taken, the interval timer shooting will stop and be automatically canceled.



- Using a tripod is recommended.
- Taking test shots in advance is recommended.
- After the interval timer shooting starts, you can still press the shutter button completely to take a picture as usual. However, approx. 5 sec. before the next interval timer shooting, the shooting function settings, menu operation, image playback, and other operations will be suspended, and the camera will go back to shooting-ready state.
- If a picture is being taken or an image is being processed when the next shot is scheduled on the interval timer, the shot set for that time will be skipped. The camera will thereby shoot fewer shots than the number set for interval timer shooting.
- Auto power off takes effect also with the interval timer after approx. 8 sec. of non-operation regardless of the [**F2: Auto power off**] setting. The power will automatically turn on approx. 1 min. before the next shot.
- Interval timer shooting can also be combined with AEB, white balance bracketing, multiple exposures, and HDR mode.
- You can stop the interval timer shooting in progress by selecting [**Disable**] or turning the power switch to < **OFF** >.





- Do not point the camera toward an intense light source, such as the sun or an intense artificial light source. Doing so may damage the image sensor or the camera's internal components.
- If the lens's focus mode switch is set to <AF>, the camera will not shoot when focus is not achieved. Setting it to <MF> and focusing manually before shooting is recommended.
- Live View shooting, movie shooting, or bulb exposures cannot be performed with interval timer.
- If the shooting time is long, using the household power outlet accessories (sold separately, p.520) is recommended.
- If a shutter speed longer than the shooting interval, such as a long exposure, is set, the camera cannot shoot with the set interval. The camera will thereby shoot fewer shots than the number set for interval timer shooting. Also, the number of shots may decrease when the shutter speed and the shooting interval are nearly the same.
- If the time it takes to record to the card exceeds the interval between shots due to the shooting functions set or card performance, some of the shots may not be taken with the set intervals.
- If you use flash with interval timer shooting, set an interval longer than the flash's recharging time. If the interval is too short, the flash may not fire.
- If the shooting interval is too short, the camera may not take a picture or may capture an image without autofocus.
- Interval timer shooting will be canceled and reset to [Disable] if you do any of the following: Setting the power switch to <OFF>, displaying the Live View shooting or movie shooting screen, setting the shooting mode to <B>, <G>, or <Q>, or using EOS Utility (EOS software, p.594).
- After interval timer shooting starts, you cannot use remote control shooting (p.271) or remote-release shooting with an EOS-dedicated, external Speedlite.
- If your eye will not remain on the viewfinder eyepiece during interval timer shooting, attach the eyepiece cover (p.270). If stray light enters the viewfinder when the picture is taken, it may throw off the exposure.

## Using the Eyepiece Cover

When you take a picture without looking through the viewfinder, such as when you use the self-timer, bulb exposure, or a remote switch, stray light entering the viewfinder may cause the picture to look dark (underexposed). To prevent this, use the eyepiece cover (p.38) attached to the camera strap.

Note that attaching the eyepiece cover is not necessary in Live View shooting or movie shooting.

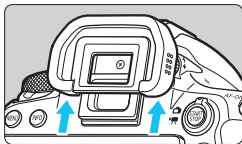

### 1 Detach the eyecup.

- Push the bottom of the eyecup to detach it.

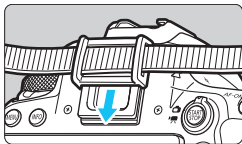

### 2 Attach the eyepiece cover.

- Slide the eyepiece cover down into the eyepiece groove to attach it.
- After you finish shooting, detach the eyepiece cover and attach the eyecup.

# Remote Control Shooting

You can use Remote Controller RC-6 (with infrared control, sold separately) or Wireless Remote Control BR-E1 (with Bluetooth, sold separately) for remote control shooting.

## Remote Controller RC-6 (Sold Separately)



You can shoot remotely up to approx. 5 meters/ 16.4 feet away from the camera. You can either shoot immediately or with a 2-sec. delay.

**1 Focus on the subject.**

**2 Set the lens's focus mode switch to <MF>.**

- You can also shoot with <AF>.

**3 Press the <DRIVE> button (ⓘ6).**

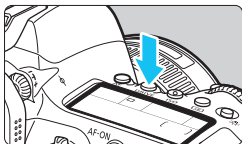

**4 Select the self-timer/remote controller.**

- Look at the LCD panel or viewfinder and turn the <ⓘ6> dial to select <ⓘ6> or <ⓘ6\_2>.

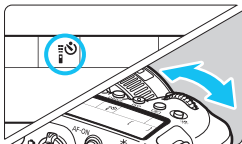

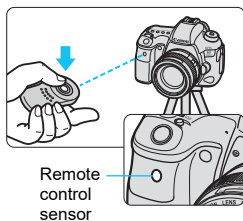

## 5 Press the remote controller's release (transmit) button.

- Point the remote controller toward the camera's remote control sensor, then press the release (transmit) button.
- ▶ The self-timer/remote control lamp lights up and the picture is taken.

- ⓘ ● If you select <SC> in step 4, you cannot perform remote control shooting.
- Under [**1: Wireless communication settings**], if [**Bluetooth function**] is set to [**Smartphone**] or [**Remote**], you cannot use infrared remote controllers such as the RC-6 for remote control shooting.
- Fluorescent or LED lighting may cause camera misoperation by triggering the shutter inadvertently. Try to keep the camera away from such light sources.
- If you point a remote controller for a TV set toward the camera and operate it, it may cause camera misoperation by triggering the shutter inadvertently.
- If flash light is emitted from a flash on another camera around this camera, it may cause camera malfunction by triggering the shutter inadvertently. Do not expose the remote control sensor to flash light from a flash on another camera.

- ⓘ ● You can also use Remote Controller RC-1 and RC-5 (infrared remote controller).
- Remote control shooting is also possible with devices such as an EX-series Speedlite equipped with a remote-release function (sold separately).
- If remote control shooting is enabled, the auto power off will take effect in approx. 2 min. even if [**2: Auto power off**] is set to [**1 min.**].
- Remote control also works with movie shooting (p.381).

## Wireless Remote Control BR-E1 (Sold Separately)

Wireless Remote Control BR-E1 (sold separately) compatible with Bluetooth® low energy technology enables remote control shooting up to approx. 5 meters/16.4 feet from the camera.

To use the **BR-E1**, you must first pair the camera and remote controller so they recognize each other.

### Pairing

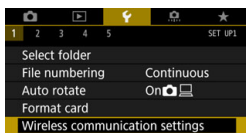

#### 1 Select [Wireless communication settings].

- Under the [**1**] tab, select [Wireless communication settings], then press < **SET** >.

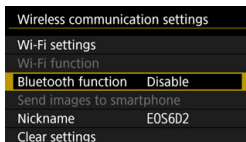

#### 2 Select [Bluetooth function].

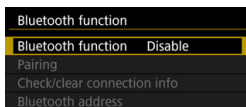

#### 3 Select [Bluetooth function].

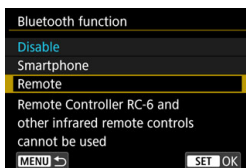

#### 4 Select [Remote].

- If the message “Register a nickname to identify the camera.” appears, press < **SET** > and register a nickname. For the procedure to register a nickname, refer to page 13 of the “Wi-Fi (Wireless Communication) Function Instruction Manual”.

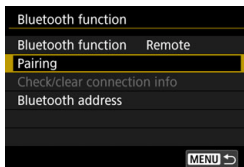

## 5 Select [Pairing].

- Select [**Pairing**], then press <SET>.
- Press and hold the <W> button and <T> button on the BR-E1 simultaneously for 3 sec. or more.
- ▶ Pairing starts.
- For instructions after the pairing is complete, refer to the BR-E1's Instruction Manual.
- ▶ When the pairing is complete, the remote controller will be registered in the camera and the screen shown on the left will appear.

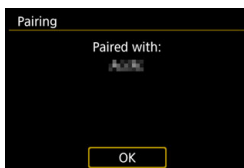

- ⓘ ● Even if the camera's power is turned off by the auto power off function, the camera battery will still be consumed with the Bluetooth connection established.
- If you selected [**Smartphone**] or [**Remote**] in step 4, you cannot use infrared remote control units such as Remote Controller RC-6 (sold separately).

- ⓘ ● When you do not use the Bluetooth function, setting it to [**Disable**] in step 4 is recommended. To use the remote controller again, just select [**Remote**] again to automatically reconnect with the camera.
- If remote control shooting is enabled, the auto power off will take effect in approx. 2 min. even if [**2: Auto power off**] is set to [**1 min.**].
- The remote controller can also be used for movie shooting (p.381).
- During shooting, the camera's self-timer/remote control lamp will light up briefly.
- For the Bluetooth connection indicator, refer to "Wi-Fi (Wireless Communication) Function Instruction Manual" (p.4).

## Canceling the Pairing

To pair the camera with another Wireless Remote Control BR-E1 (sold separately), clear the pairing (registration) with the current remote controller. You can check the connection status of the camera and remote controller on the **[Check/clear connection info]** screen in step 4.

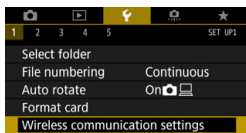

### 1 Select **[Wireless communication settings]**.

- Under the **[1]** tab, select **[Wireless communication settings]**, then press **<SET>**.

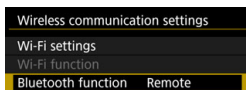

### 2 Select **[Bluetooth function]**.

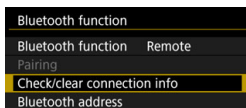

### 3 Select **[Check/clear connection info]**.

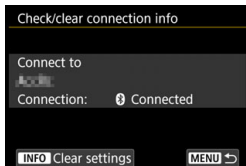

### 4 Check the display.

- The BR-E1's Bluetooth address is indicated by **[Connect to]**.
- If the remote controller is not used, **[Connecting...]** will be displayed for **[Connection]**.

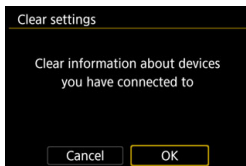

### 5 Press the **<INFO>** button.

### 6 Clear the connection information.

- Select **[OK]**.
- ▶ Pairing with the remote controller (registration of the remote controller) will be cleared.

## Using a Remote Switch

You can connect any EOS accessory equipped with an N3-type terminal such as the Remote Switch RS-80N3 or Timer Remote Controller TC-80N3 (each sold separately) to shoot with the camera (p.515).

To operate the accessory, refer to its Instruction Manual.

---

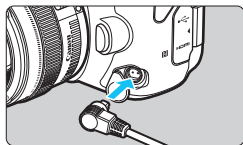

**1** Open the terminal cover.

**2** Connect the plug to the remote control terminal.

- Connect the plug as shown in the illustration.
- To disconnect the plug, grasp the silver part and pull it out.



# 7

## Flash Photography

This chapter describes how to shoot with external EX-series Speedlites (sold separately) and how to set Speedlite settings on the camera's menu screen.

## ⚡ Flash Photography

### EOS-dedicated, EX-series Speedlites

Using an EX-series Speedlite (sold separately) makes flash photography easy.

**For operation procedures, refer to the EX-series Speedlite's Instruction Manual.** This camera is a Type-A camera that can use all the features of EX-series Speedlites.

To set the flash functions and flash Custom Functions on the camera's menu screen, see pages 281-287.



Shoe-mount Speedlites



Macro Lites

- **Flash exposure compensation**

You can adjust the flash output (flash exposure compensation) with Quick Control (p.61) or with **[Flash function settings]** under **[CAMERA 1: External Speedlite control]** (p.283). You can set flash exposure compensation up to  $\pm 3$  stops in 1/3-stop increments.

- **FE lock**

This enables you to attain an appropriate flash exposure for a specific part of the subject. Aim the viewfinder center over the subject, press the camera's **< \* >** button, then compose the shot and take the picture.



If the [ **2: Auto Lighting Optimizer**] (p. 194) setting is not [**Disable**], the image may still look bright even if a decreased exposure compensation is set for a darker exposure.



If it is difficult to achieve focus with autofocus, the EOS-dedicated, external Speedlite will automatically emit the AF-assist beam as necessary.

## Canon Speedlites Other Than the EX-series

- **With an EZ/E/EG/ML/TL-series Speedlite set to A-TTL or TTL autoflash mode, the flash can be fired at full output only.** Set the camera's shooting mode to <**M**> manual exposure or <**Av**> aperture-priority AE and adjust the aperture setting before shooting.
- When using a Speedlite that has manual flash mode, shoot in the manual flash mode.

## Non-Canon Flash Units

### ● Sync Speed

The camera can synchronize with non-Canon compact flash units at 1/180 sec. and slower speeds. With large studio flash units, the flash duration is longer than that of a compact flash unit and varies depending on the model. Be sure to check before shooting if flash sync is properly performed by test shooting at a sync speed of approx. 1/60 sec. to 1/30 sec.

### ● Cautions for Live View Shooting

If you use a non-Canon flash unit with Live View shooting, set [**📷5: Silent LV shoot.**] to [**Disable**] (p.303). The flash will not be fired if it is set to [**Mode 1**] or [**Mode 2**].

- If the camera is used with a flash unit or flash accessory dedicated to another camera brand, the camera not only may not operate properly, but malfunction may result.
- Do not attach a high-voltage flash unit to the camera's hot shoe. It may not be fired.

## MENU Setting the Flash Function ☆

With an EX-series Speedlite having compatible flash function settings, you can use the camera's menu screen to set the Speedlite's functions and Custom Functions. **Attach the Speedlite to the camera and turn on the Speedlite before setting the flash functions.**

For details on the Speedlite's functions, refer to the Speedlite's Instruction Manual.

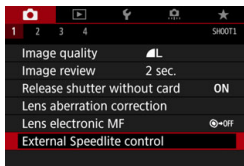

### 1 Select [External Speedlite control].

- Under the [📷 1] tab, select [External Speedlite control], then press <ⓈET>.
- ▶ The external Speedlite control screen will appear.

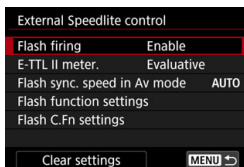

### 2 Select the desired item.

- Select the menu option to be set, then press <ⓈET>.

## Flash Firing

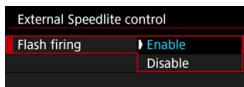

To enable flash photography, set [Enable]. To enable only the AF-assist beam to be emitted, set [Disable].

## E-TTL II Flash Metering

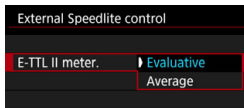

For normal flash exposures, set it to [Evaluative]. If [Average] is set, the flash exposure will be averaged for the entire metered scene. Depending on the scene, flash exposure compensation may be necessary. This setting is for advanced users.

## Flash Sync. Speed in Av Mode

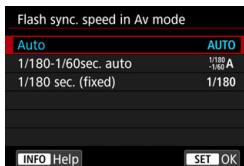

You can set the flash-sync speed for flash photography in the <Av> aperture-priority AE mode.

- **AUTO: Auto**

The flash sync speed is set automatically within a range of 1/180 sec. to 30 sec. to suit the scene's brightness. High-speed sync is also possible.

- **$\frac{1}{180}$ - $\frac{1}{60}$ A: 1/180-1/60sec. auto**

Prevents a slow shutter speed from being set in low-light conditions. It is effective for preventing subject blur and camera shake.

However, while the subject will be properly exposed with the flash, the background may come out dark.

- **1/180: 1/180 sec. (fixed)**

The flash sync speed is fixed at 1/180 sec. This more effectively prevents subject blur and camera shake than with [1/180-1/60sec. auto]. However, in low light, the subject's background will come out darker than with [1/180-1/60sec. auto].

ⓘ If [1/180-1/60sec. auto] or [1/180 sec. (fixed)] is set, high-speed sync is not possible in the <Av> mode.

## Flash Function Settings

The screen display and setting options will vary depending on the Speedlite model, current flash mode, Speedlite's Custom Function settings, etc.

For details on the Speedlite's functions, refer to the Speedlite's Instruction Manual.

### Sample display

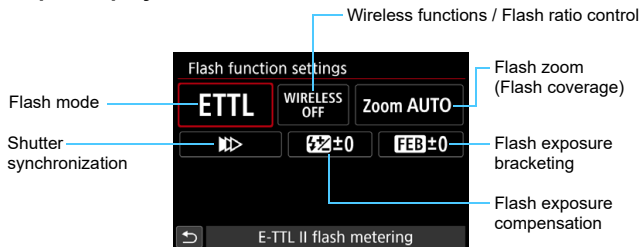

### ● Flash mode

You can select the flash mode to suit your desired flash photography.

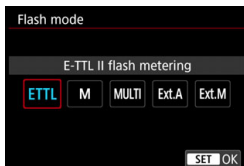

**[E-TTL II flash metering]** is the standard mode of EX-series Speedlites for automatic flash photography.

**[Manual flash]** is for setting the Speedlite's **[Flash output level]** yourself.

Regarding other flash modes, refer to the Instruction Manual of a Speedlite compatible with the respective flash mode.

## ● Wireless functions / Flash ratio control

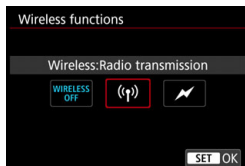

Wireless (multiple) flash photography is possible with radio or optical transmission.

For details on wireless flash, refer to the Instruction Manual of a Speedlite compatible with wireless flash photography.



With a macro flash (MR-14EX II, etc.) compatible with flash function settings, you can set the flash ratio between flash tubes or flash heads A and B, or use wireless flash with additional receiver units.

For details on flash ratio control, refer to the macro flash's Instruction Manual.

## ● Flash zoom (Flash coverage)

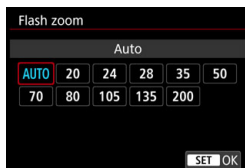

With Speedlites having a zooming flash head, you can set the flash coverage. Normally, set this to **[AUTO]** so that the camera will automatically set the flash coverage to match the lens focal length.



## ● Shutter synchronization

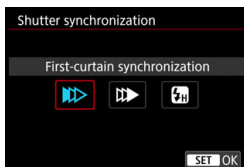

Normally, set this to [**First-curtain synchronization**] so that the flash fires immediately after the exposure starts.

If [**Second-curtain synchronization**] is set, the flash will be fired right before the shutter closes. When this is combined with a slow shutter speed, you can create a trail of light such as from car headlights at night with a more natural feel. When second-curtain synchronization is set together with [**E-TTL II flash metering**], the flash will be fired twice in a row: once when you press the shutter button completely and once right before the end of the exposure.

If [**High-speed synchronization**] is set, the flash can be used at all shutter speeds. This is effective when you want to shoot with background blur (open aperture) in locations such as outdoors in daylight.

## ● Flash exposure compensation

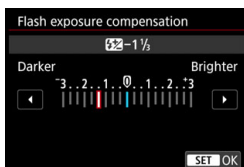

You can set flash exposure compensation up to  $\pm 3$  stops in 1/3-stop increments.

For details, refer to the Speedlite's Instruction Manual.

## ● Flash exposure bracketing

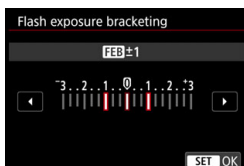

While changing the flash output automatically, three shots will be taken. For details, refer to the Instruction Manual of a Speedlite equipped with flash exposure bracketing.

**I** When using second-curtain synchronization, set the shutter speed to 1/25 sec. or slower. If the shutter speed is 1/30 sec. or faster, first-curtain synchronization will be applied automatically even if **[Second-curtain synchronization]** is set.

- I**
- With an EX-series Speedlite not compatible with flash function settings, you can only set the following: **[Flash firing]**, **[E-TTL II meter.]**, and **[Flash exposure compensation]** under **[Flash function settings]**. (**[Shutter synchronization]** can also be set with certain EX-series Speedlites.)
  - If flash exposure compensation is set with the Speedlite, you cannot set the flash exposure compensation with the camera. If it is set with both the camera and Speedlite, the Speedlite's setting overrides the camera's.

## Flash Custom Function Settings

For details on the Speedlite's Custom Functions, refer to the Speedlite's (sold separately) Instruction Manual.

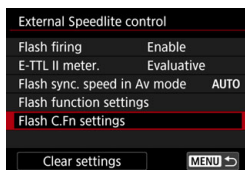

**1** Select **[Flash C.Fn settings]**.

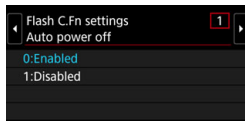

**2** Set the desired functions.

- Select the number, then press **< (SET) >**.
- Select the setting, then press **< (SET) >**.

**I** With an EX-series Speedlite, the Speedlite will always fire at full output if the **[Flash metering mode]** Custom Function is set to **[TTL]** (autoflash).

## Clearing Flash Function Settings / Flash C.Fn Settings

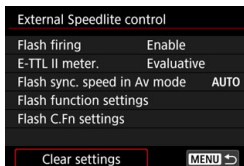

1 Select [Clear settings].

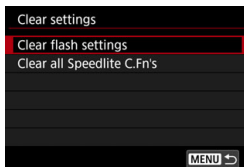

2 Select the settings to be cleared.

- Select [Clear flash settings] or [Clear all Speedlite C.Fn's], then press < (SET) >.
- On the confirmation dialog, select [OK]. Then the flash settings or Custom Function settings will all be cleared.



The Speedlite's Personal Function (P.Fn) cannot be set or canceled on the camera's [📷 1: External Speedlite control] screen. Set it directly on the Speedlite.



# 8

## Shooting with the LCD Monitor (Live View Shooting)

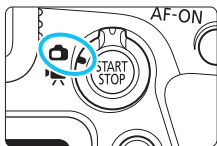

You can shoot while viewing the image on the camera's LCD monitor. This is called "Live View shooting".

Live View shooting is enabled by setting the Live View shooting/Movie shooting switch to <img alt="camera icon" data-bbox="758 593 793 613"/>.

- If you handhold the camera and shoot while viewing the LCD monitor, camera shake may cause blurred images. Using a tripod is recommended in such cases.
- For instructions on how to hold the camera, see page 99.



### Remote Live View Shooting

With EOS Utility (EOS software, p.594) installed on your computer, you can connect the camera to the computer and shoot remotely while viewing the computer screen. For details, refer to the EOS Utility Instruction Manual (p.596).

## Shooting with the LCD Monitor



- 1** Set the Live View shooting/Movie shooting switch to .



- 2** Display the Live View image.

- Press the  button.
- ▶ The Live View image will appear on the LCD monitor.
- The Live View image will be displayed in the brightness level closely matching that of the actual image to be captured.

- 3** Select a shooting mode.

- Turn the Mode Dial to select the shooting mode.



- 4** Focus on the subject.

- When you press the shutter button halfway, the camera will focus with the current AF method (p.308).
- You can also tap on the screen to select the face or subject (p.319).

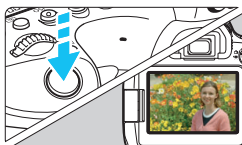

- 5** Take the picture.

- Press the shutter button completely.
- ▶ The picture is taken and the captured image is displayed on the LCD monitor.
- ▶ When the playback display ends, the camera will return to Live View shooting automatically.
- Press the  button to exit Live View shooting.

## Enabling Live View Shooting

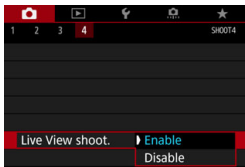

Set [**4: Live View shoot.**] (under the [**1**] tab in Basic Zone modes) to [**Enable**].

## Number of Possible Shots with Live View Shooting

(Approx. number of shots)



Temperature	Room Temperature (23°C / 73°F)	Low Temperatures (0°C / 32°F)
<b>Possible Shots</b>	380	340



- The figures above are based on a fully-charged Battery Pack LP-E6N and CIPA (Camera & Imaging Products Association) testing standards.
- With Battery Grip BG-E21 (sold separately) loaded with two LP-E6N battery packs, the number of possible shots will be approximately doubled.
- With a fully-charged Battery Pack LP-E6N, the continuous Live View shooting time will be as follows: At room temperature (23°C/73°F): Approx. 3 hr. 10 min., At low temperatures (0°C/32°F): Approx. 2 hr. 50 min.

## Continuous Shooting Display

For < **H** > High-speed continuous shooting or < **L** > Low-speed continuous shooting during Live View shooting with the image-recording quality set to JPEG or **RAW** (except **M RAW** and **S RAW**), holding down the shutter button will display (play back) the captured images continuously. When the continuous shooting ends (shutter button is returned to halfway position), the Live View image will be displayed.

- Depending on the shooting conditions such as when shooting long exposures, the captured images may not be displayed (played back) continuously.

- ⓘ Do not point the camera toward an intense light source, such as the sun or an intense artificial light source. Doing so may damage the image sensor or the camera's internal components.
- In the <SCN: > mode, Live View shooting is not possible.
- In the <SCN: > mode, the angle of view changes slightly in Live View shooting because distortion correction is applied.
- In the <SCN: > modes or when [**3: HDR Mode**] is set, the shooting area will become smaller.
- “**General Live View Shooting Cautions**” are on pages 323-324.

- 📄 The image's field of view coverage is approx. 100% (with image-recording quality set to JPEG  and aspect ratio set to 3:2).
- You can set exposure compensation up to ±3 stops by setting the <LOCK> switch downward and turning the  dial (except in Basic Zone modes).
- To check the depth of field, press the depth-of-field preview button.
- If you shoot with the image-recording quality set to **M RAW** or **S RAW**, “**BUSY**” will be displayed and shooting will be disabled temporarily.
- You can also focus by pressing the <AF-ON> button.
- When flash is used, there will be two shutter sounds, but only one shot will be taken. Also, the time it takes to take the picture after you press the shutter button completely will be slightly longer than with viewfinder shooting.
- If the camera is not operated for a prolonged period, the power will turn off automatically after the time set in [**2: Auto power off**] (p.73). If [**2: Auto power off**] is set to [**Disable**], Live View shooting will end automatically after approx. 30 min. (camera power remains on).
- With the HDMI cable HTC-100 (sold separately), you can display the Live View image on a TV set (p.427). Note that no sound will be output. If the picture does not appear on the TV screen, check if the [**3: Video system**] is correctly set to [**For NTSC**] or [**For PAL**] (depending on the video system of your TV set).
- You can also use a remote controller (sold separately, p.271) for Live View shooting.



## Information Display

Each time you press the <INFO> button, the information display will change.

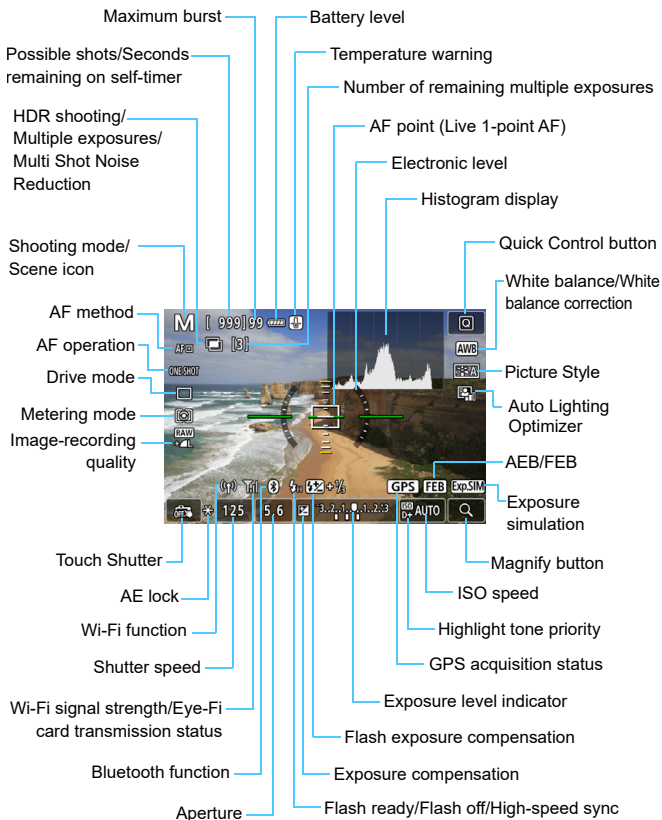



- The display will show only the settings currently applied.

## ⚠️ Warnings

**Do not hold the camera in the same position for long periods of time.**

Even if the camera does not feel too hot, prolonged contact with the same body part may cause skin redness or blistering due to low-temperature contact burns. Using a tripod is recommended when using the camera in very hot places or for people with circulation problems or poor skin sensation.

- The histogram can be displayed when [**5: Expo. simulation**] is set to **[Enable]** (p.303).
- You can display the electronic level by pressing the <INFO> button (p.80). Note that if the AF method is set to [**L+Tracking**] or the camera is connected to a TV set with an HDMI cable, the electronic level cannot be displayed.
- When <Exp.SIM> is displayed in white, it indicates that the Live View image is displayed at the brightness level closely matching that of the actual image to be captured.
- If <Exp.SIM> is blinking, it indicates that the Live View image is displayed at a brightness that differs from the actual shooting result because of low- or bright-light conditions. However, the actual image recorded will reflect the exposure setting. Note that the noise may be more noticeable than the actual image recorded.
- Exposure simulation (p.303) will not work with either of the <SCN:  > modes, bulb exposures, flash photography, Multi Shot Noise Reduction, or the HDR mode. The <Exp.SIM> icon and histogram will be displayed in gray. The image will be displayed on the LCD monitor at the standard brightness. The histogram may not be properly displayed in low- or bright-light conditions.

## Scene Icons

In the  $\langle \text{A}^+ \rangle$  shooting mode, the camera detects the scene type and sets everything automatically to suit the scene. The detected scene type is indicated on the upper left of the screen.

Subject Background	Portrait <sup>*1</sup>		Non-portrait			Background Color
		Movement	Nature and Outdoor Scene	Movement	Close <sup>*2</sup>	
Bright						Gray
Backlit						
Blue Sky Included						Light blue
Backlit						
Sunset	*3			*3		Orange
Spotlight						Dark blue
Dark						
With Tripod	*4*5	*3	*4*5	*3		

\*1: Displayed only when the AF method is set to  $[\text{A}^+ + \text{Tracking}]$ . If another AF method is set, the "Non-portrait" icon will be displayed even if a person is detected.

\*2: Displayed when the attached lens has distance information. With an extension tube or close-up lens, the icon displayed may not match the actual scene.

For certain scenes or shooting conditions, the icon displayed may not match the actual scene.

\*3: The icon of the scene selected from the detectable scenes will be displayed.

\*4: Displayed when all the following conditions apply:

The shooting scene is dark, it is a night scene, and the camera is mounted on a tripod.

\*5: Displayed with any of the lenses below:

EF300mm f/2.8L IS II USM

EF400mm f/2.8L IS II USM

EF500mm f/4L IS II USM

EF600mm f/4L IS II USM

Image Stabilizer lenses released in and after 2012.

\*4+\*5: If the conditions in both \*4 and \*5 are met, the shutter speed will slow down.

## Final Image Simulation

Final image simulation is a function that shows the Live View image with the effects of the current settings for Picture Style, white balance, and other shooting functions applied.

The Live View image will automatically reflect the function settings listed below. However, the displayed image may be slightly different from the resulting image.

### Final Image Simulation During Live View Shooting

- Picture Style
  - \* Sharpness (Strength), contrast, color saturation, and color tone will be reflected.
- White balance
- White balance correction
- Ambience-based shots (in <CA> mode)
- Background blur (in <CA> mode)
  - \* You can check the effect only during the setting procedure (when [Simulating blur] is displayed).
- Color tone (in <Ff> mode)
- Brightness
- Metering mode
- Exposure (with [ 5: Expo. simulation: Enable] set)
- Depth of field (with depth-of-field preview button ON)
- Auto Lighting Optimizer
- Peripheral illumination correction
- Chromatic aberration correction
- Distortion correction
- Highlight tone priority
- Aspect ratio (Image area confirmation)

## INFO Button Display Options

You can set the information to be displayed on the image for when you press the <INFO> button during Live View shooting or movie shooting.

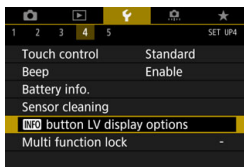

### Select [INFO button LV display options].

- Under the [F4] tab, select [INFO button LV display options], then press <SET>.

### Live View info switch setting

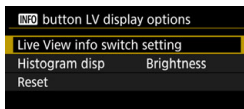

### 1 Select [Live View info switch setting].

### 2 Select a number.

- The numbers 1 to 4 indicate the number of times to press the <INFO> button to display the respective information starting with nothing displayed on the screen.
- Select the number for the displayed information you want to change, then press the <INFO> button.
- To remove a number's checkmark [✓], press <SET>. Note that you cannot remove the [✓] for all four display options.



The default settings are shown below.

Information / Number		1	2	3	4
	Basic shooting info	○	○	○	—
	Detailed shooting info	—	○	○	—
	On-screen buttons	○	○	○	—
	Histogram	—	—	○	—
	Electronic level	—	—	○	—

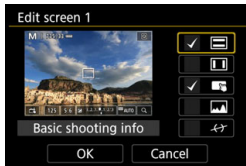

### 3 Edit the options.

- Select what you want to be displayed and press **<SET>** to add a checkmark [✓].
- For the information you do not want to be displayed, press **<SET>** to remove the checkmark [✓].
- Then select **[OK]** to register the setting.
- Repeat steps 2 and 3 as necessary.

#### • Histogram display

##### • Brightness/RGB

The histogram (p.398) to be displayed when you press the **<INFO>** button can be either the **[Brightness]** or **[RGB]** histogram.

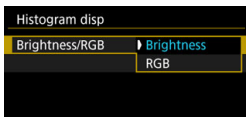

Under **[Histogram disp]**, select **[Brightness/RGB]** and select **[Brightness]** or **[RGB]**.

##### • Display size

You can change the display size of the histogram.





Under **[Histogram disp]**, select **[Display size]** and select **[Large]** or **[Small]**.

#### • Reset



In step 1, if you select **[Reset]**, the **[F4: INFO button LV display options]** setting will be cleared.



# Shooting Function Settings

## AF/DRIVE/ISO/ Settings

When the Live View image is displayed, if you press the <AF>, <DRIVE>, <ISO>, or <> button, the setting screen will appear on the LCD monitor and you can turn the <> or <> dial to set the respective shooting function.

- After pressing the <AF> button, you can turn the <> dial to set the AF method (p.308) or press the <◀> <▶> keys to set the AF operation (p.305).

 With Live View shooting, the <S> or <S> drive mode cannot be set. Also, the continuous shooting mode set for viewfinder shooting will not be applied to Live View shooting.

 When you set <> (Partial metering) or <> (Spot metering), a metering circle will be displayed at the center of the screen.



## Q Quick Control

With the image displayed on the LCD monitor, you can press the <Q> button and set the following functions.

In Creative Zone modes, the following can be set: **AF method**, AF operation, **Drive mode**, Metering mode, **Image quality**, White balance, Picture Style, and Auto Lighting Optimizer.

**In Basic Zone modes, you can set the functions shown in boldface and those in the table on page 127 (except background blur).**



### 1 Press the <Q> button (10).

- ▶ The settable functions will be displayed.

### 2 Select a function and set it.

- Press the <▲> <▼> keys to select a function.
  - ▶ The settings of the selected function and Feature guide will appear on the screen.
  - Turn the <☀> or <⌚> dial to set it.
- Press the <INFO> button for the following: To set the RAW image-recording quality, drive mode's <Ⓞc> setting, the white balance shift or white balance bracketing, or the Picture Style parameters.
- To set Auto white balance, select [**AWB**] (or [**AWB w**]), then press <SET>.
- To return to Live View shooting, press <SET> or the <Q> button.
- You can also select [↶] to return to Live View shooting.



With [**AF operation**] set to [**Servo AF**], you cannot select **M RAW** or **S RAW** when setting the quality for a RAW image with [**Image quality**].

## MENU Menu Function Settings

### 5

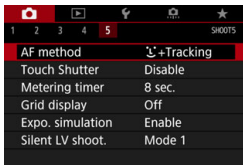

With Live View shooting, menu options exclusive to Live View shooting will appear under the [5] tab (the [2] tab in Basic Zone modes).

The settable functions on this menu screen apply only to Live View shooting. They do not work with viewfinder shooting (settings are disabled).

- **AF method**

You can select [**+Tracking**], [**Smooth zone**], or [**Live 1-point AF**]. See pages 308-314 for the AF method.



- **Touch Shutter**

You can set Touch Shutter to [**Disable**] or [**Enable**]. Just by tapping on the LCD monitor screen, you can focus and take the picture automatically. For details, see page 319.

- **Metering timer**<sup>★</sup>

You can change how long the exposure setting is displayed (AE lock time).

- **Grid display**

With [**3x3** ] or [**6x4** ], you can display grid lines to help you level the camera vertically or horizontally. Also, with [**3x3+diag** ], the grid is displayed together with diagonal lines to help you compose with better balance by aligning the intersections over the subject.



- **Exposure simulation** <sup>☆</sup>

Exposure simulation simulates and displays how the brightness (exposure) of the actual image will look.

- **Enable** (Exp.SIM)

The displayed image brightness will be close to the actual brightness (exposure) of the resulting image. If you set exposure compensation, the image brightness will change accordingly.

- **During** 

Normally, the image is displayed at the standard brightness to make the Live View image easy to see (). The image will be displayed with a brightness (exposure) close to that of the actual image to be captured only while you hold down the depth-of-field preview button ().

- **Disable** ()

The image is displayed at the standard brightness to make the Live View image easy to see. Even if you set exposure compensation, the image is displayed at the standard brightness.

- **Silent LV shooting** <sup>☆</sup>

- **Mode 1**





Mechanical sound during shooting is suppressed, compared with viewfinder shooting. Continuous shooting is also possible.

- **Mode 2**

When the shutter button is pressed completely, only one shot will be taken. While you keep holding down the shutter button, the camera operation will be suspended. Then when you return to the shutter button's halfway position, the camera operation will resume. The release sound at the moment of shooting can thereby be minimized. Even if continuous shooting is set, only a single shot will be taken.

## • Disable

Be sure to set it to **[Disable]** if you use a TS-E lens (other than those listed in ) **for shifting or tilting the lens** or if you use an extension tube. If **[Mode 1]** or **[Mode 2]** is set, the standard exposure may not be obtained, or an irregular exposure may result.

- With **[Mode 2]** set, continuous shooting will not work even if you set the drive mode to  or .
- If you use flash with the flash mode set to E-TTL II/E-TTL autoflash, shutter release will be performed by the same internal operation mechanism as with viewfinder shooting. Therefore, shooting while suppressing the mechanical sound will not be possible (regardless of the **[Silent LV shoot.]** setting).
- When using a non-Canon flash unit, set it to **[Disable]**. The flash will not be fired if it is set to **[Mode 1]** or **[Mode 2]**.
- If **[Mode 2]** is set and you use a remote controller (p.271), the operation will be the same as with **[Mode 1]**.
- Selecting **[3: Dust delete data]** or either **[Clean manually]** or **[Clean now ** under **[4: Sensor cleaning]** will stop the Live View shooting. To start Live View shooting again, press the  button.

 With the TS-E17mm f/4L or TS-E24mm f/3.5L II lens, you can use **[Mode 1]** or **[Mode 2]**.

# Selecting the AF Operation ☆

You can select the AF operation characteristics to suit the shooting conditions or subject. In Basic Zone modes, the optimum AF operation is set automatically for the respective shooting mode.

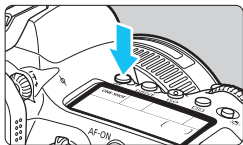

## 1 Press the <AF> button.

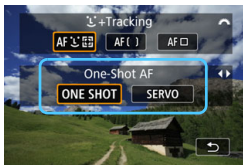

## 2 Select the AF operation.

- Press the <◀> <▶> keys to select the desired AF operation, then press <SET>.

**ONE SHOT** : One-Shot AF

**SERVO** : Servo AF

## 3 Focus on the subject.





- Aim the AF point over the subject and press the shutter button halfway. The camera will then autofocus in the selected AF operation.





- Settable only for Live View shooting (not settable for movie shooting).
- If focus cannot be achieved, the AF point will turn orange. If this occurs, the picture cannot be taken even if the shutter button is pressed completely. Recompose the shot and try to focus again. Or, see “Shooting Conditions that Make Focusing Difficult” (p.316).

## One-Shot AF for Still Subjects

**Suited for still subjects. When you press the shutter button halfway, the camera will focus only once.**

- When focus is achieved, the AF point will turn green and the beeper will sound.
- The focus remains locked while you hold down the shutter button halfway, allowing you to recompose the image before taking the picture.
- When the drive mode is set to <  H > for **high-speed continuous shooting**, the maximum continuous shooting speed is **approx. 6.5 shots/sec.**
- When the drive mode is set to <  > for **low-speed continuous shooting**, the maximum continuous shooting speed is **approx. 3.0 shots/sec.**
- **When an external Speedlite is used**, the continuous shooting speed will become slower. Regardless of the <  H > and <  > settings, the maximum continuous shooting speed will be **approx. 1.7 shots/sec.**

 If [  4: Beep ] is set to [ **Disable** ], the beeper will not sound when focus is achieved.

## Servo AF for Moving Subjects

This AF operation is suited for moving subjects. While you hold down the shutter button halfway, the camera will keep focusing on the subject continuously.

- When focus is achieved, the AF point will turn blue.
- The exposure is set at the moment the picture is taken.
- When [**5: AF method**] is set to [**┆+Tracking**] or [**Smooth zone**], focusing will be continuous as long as the Area AF frame or Zone AF frame keeps tracking the subject.
- When the drive mode is set to <[**□H**]> for **high-speed continuous shooting**, the maximum continuous shooting speed is **approx. 4.0 shots/sec**. The pictures will be taken with priority given to the continuous shooting speed.
- When the drive mode is set to <[**□**]> for **low-speed continuous shooting**, the maximum continuous shooting speed is **approx. 3.0 shots/sec**. The pictures will be taken with priority given to subject tracking.
- When an external Speedlite is used, the continuous shooting speed will become slower. Regardless of the <[**□H**]> and <[**□**]> settings, the maximum continuous shooting speed will be **approx. 1.7 shots/sec**.



- Depending on the lens used, the distance to the subject and the subject's speed, the camera may not be able to achieve correct focus.
- Zooming during continuous shooting may throw off the focus. Zoom first, then recompose and shoot.
- When [**Servo AF**] is set, the image-recording quality cannot be set to **M RAW** or **S RAW**. If **M RAW** or **S RAW** is set, the image will be recorded in **RAW** quality.
- When [**Servo AF**] is set and [**Multi Shot Noise Reduction**] is set (p.195), [**High ISO speed NR**] will automatically switch to [**Standard**].



With Servo AF, the beeper will not sound even when focus is achieved (except with <[**SCN**: ]> mode).

# Focusing with AF (AF Method)

## Selecting the AF Method

You can set the AF method to [**L**+Tracking] (p.309), [**Smooth zone**] (p.311), or [**Live 1-point AF**] (p.313) to suit the shooting conditions and subject.

If you want to focus manually, set the lens's focus mode switch to <MF>, magnify the image, and focus manually (p.321).

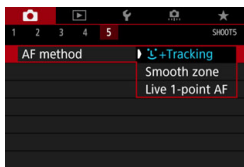

## Select the AF method.

- Under the [**5**] tab, select [**AF method**]. (For movie shooting, it is under the [**4**] tab. In Basic Zone modes, under the [**2**] tab.)
- Select the desired AF method, then press <SET>.
- While the Live View image is displayed, you can also select the AF method by pressing the <AF> button and turning the <DIAL> dial.

- The descriptions on pages 309-314 assume that [**AF operation**] is set to [**One Shot AF**] (p.305). With [**Servo AF**] (p.307) set, the AF point will turn blue when focus is achieved.
- Regarding the Touch Shutter (AF and shutter release by touch operation), see page 319.



**☺(face)+Tracking: AF**

The camera detects and focuses on human faces. If a face moves, the AF point <☺> also moves to track the face.

**1 Display the Live View image.**

- Press the <START/STOP> button.
- ▶ The Live View image will appear on the LCD monitor.
- ▶ The Area AF frame will appear.



Area AF frame

**2 Check the AF point.**

- When a face is detected, <☺> will appear over the face to be focused on.
- If multiple faces are detected, <☺☺> will be displayed. Use <☼> to move <☺> over the face you want to focus on.
- You can also tap on the LCD monitor screen to select the face or subject. If you tap on a subject other than a human face, the AF point will switch to <☼>.

**3 Focus on the subject.**

- Press the shutter button halfway to focus.
- ▶ If no faces can be detected or if you do not tap anything on the screen, focus will be achieved within the Area AF frame.
- ▶ When focus is achieved, the AF point will turn green and the beeper will sound.
- ▶ If focus is not achieved, the AF point will turn orange.





## 4 Take the picture.

- Check the focus and exposure, then press the shutter button completely to take the picture (p.290).

### ● Focusing on a subject other than a human face

- Tap on the subject (or spot) where you want to focus.
- Press the  $\langle \text{SET} \rangle$  or  $\langle \text{AF} \rangle$  button and the AF point  $\langle \text{AF} \rangle$  will appear on the screen, and the AF point can be moved with  $\langle \text{AF} \rangle$ .
- Once the AF point  $\langle \text{AF} \rangle$  achieves focus, the AF point will also move to track the subject if you change the composition or if the subject moves.

- If the subject's face is significantly out of focus, face detection will not be possible. Adjust the focus manually (p.321) so that the face can be detected, then perform AF.
- An object other than a human face may be detected as a face.
- Face detection will not work if the face is very small or large in the picture, too bright or too dark, or partially hidden.
- The  $\langle \text{AF} \rangle$  may cover only a part of the face, not the whole face.

- AF is not possible on a face or subject along the periphery (outside the Area AF frame). Aim the Area AF frame over the subject for focusing.
- The size of the AF point changes depending on the subject.

## Smooth Zone: AF ( )

Focus can be achieved with a larger area (Zone AF frame) than the AF point of [Live 1-point AF] (p.313).

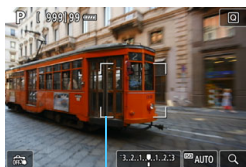

Zone AF frame

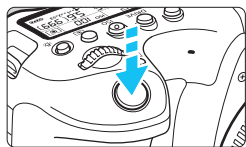

### 1 Display the Live View image.

- Press the <  $\text{START STOP}$  > button.
- ▶ The Live View image will appear on the LCD monitor.
- ▶ The Zone AF frame will appear.

### 2 Select the AF point.

- Use <  $\text{AF POINT}$  > to move the Zone AF frame to where you want to focus. (It cannot go to the edge of the screen.)
- Pressing <  $\text{SET}$  > or the <  $\text{TRASH}$  > button will return the Zone AF frame to the screen center.
- You can also touch the LCD monitor screen to move the Zone AF frame.

### 3 Focus on the subject.

- Aim the Zone AF frame over the subject and press the shutter button halfway.
- ▶ When focus is achieved, the AF points achieving focus will turn green and the beeper will sound.
- ▶ If focus is not achieved, the Zone AF frame will turn orange.



## 4 Take the picture.

- Check the focus and exposure, then press the shutter button completely to take the picture (p.290).

 If the camera does not focus on the target subject, switch to [Live 1-point AF] (p.313) and focus again.

## Live 1-point AF: AF □

The camera focuses with a single AF point. This is effective when you want to focus on a particular subject.



AF point

### 1 Display the Live View image.

- Press the <START/STOP> button.
- ▶ The Live View image will appear on the LCD monitor.
- ▶ The AF point <□> will appear.



### 2 Move the AF point.

- Use <⊙> to move the AF point to where you want to focus. (It cannot go to the edge of the screen.)
- Pressing <SET> or the <⊗> button will return the AF point to the screen center.
- You can also touch the LCD monitor screen to move the AF point.



### 3 Focus on the subject.

- Aim the AF point over the subject and press the shutter button halfway.
- ▶ When focus is achieved, the AF point will turn green and the beeper will sound.
- ▶ If focus is not achieved, the AF point will turn orange.



## 4 Take the picture.

- Check the focus and exposure, then press the shutter button completely to take the picture (p.290).

 During movie shooting, if [**4: Movie Servo AF**] is set to [**Enable**], the AF point will be displayed larger in step 1.

## Notes for AF

### AF Operation

- Even when focus is achieved, pressing the shutter button halfway will focus again.
- The image brightness may change during and after the AF operation.
- Depending on the subject and shooting conditions, it may take longer to focus, or the continuous shooting speed may decrease.
- If the light source changes while the Live View image is displayed, the screen may flicker and focusing may be difficult. If this happens, exit Live View shooting and perform AF under the actual light source under which you are shooting.



- If you cannot achieve focus with AF, set the lens's focus mode switch to <MF> and focus manually (p.321).
- If you shoot the subject at the periphery and it is slightly out of focus, recompose to move the subject (or AF point or Zone AF frame) toward the screen center, focus again, then take the picture.
- The external Speedlite will not emit the AF-assist beam. However, if an EX-series Speedlite (sold separately) equipped with an LED light is used, the LED light will turn on for AF-assist as necessary.
- With certain lenses, it may take more time to achieve focus with autofocus, or accurate focusing may not be achieved.

## Shooting Conditions that Make Focusing Difficult

- Subject with low-contrast such as the blue sky, solid-color flat surfaces or when highlight or shadow details are clipped.
- Subjects in low light.
- Stripes and other patterns where there is contrast only in the horizontal direction.
- Subjects with repetitive patterns (Example: Skyscraper windows, computer keyboards, etc.).
- Fine lines and subject outlines.
- Under a light source whose brightness, color, or pattern keeps changing.
- Night scenes or points of light.
- The image flickers under fluorescent or LED lighting.
- Extremely small subjects.
- Subjects at the edge of the screen.
- Strongly backlit or reflective subjects (Example: Car with a highly reflective body, etc.).
- Near and distant subjects covered by an AF point (Example: Animal in a cage, etc.).
- Subjects that keep moving within the AF point and will not stay still due to camera shake or subject blur.
- Performing AF when the subject is very far out of focus.
- Soft focus effect is applied with a soft focus lens.
- A special effect filter is used.
- Noise (dots of light, banding, etc.) appears on the screen during AF.



## Magnified View

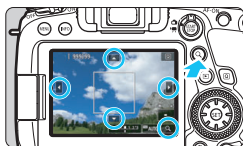

When the AF method is [**Smooth zone**] or [**Live 1-point AF**] mode, either press the <Q> button or tap on [Q] displayed on the bottom right of the screen. You can magnify the image by approx. 5x or 10x and check the focus.

Magnified view is not possible with [L+Tracking].

- To move the AF point or Zone AF frame, use <⊗> or tap on the spot you want to magnify.
- Press the <Q> button or tap on [Q] to magnify the image. Each time you press the button or tap, the magnification changes.
- When [**Smooth zone**] is set, the image will be magnified at the center of the Zone AF frame. When [**Live 1-point AF**] is set, image will be magnified around the position of the AF point.
- At 100% (approx. 1x) magnification, use <⊗> or touch the screen to move the magnifying frame. Pressing the <SET> or <⏏> button will return the magnifying frame to the screen center.
- Either press the <Q> button or tap on [Q] to magnify the area covered by the magnifying frame.
- When the image is magnified by approx. 5x or 10x, you can move the magnified area by using <⊗> or tapping on the triangle on the screen top, bottom, left, or right.
- When you press the shutter button halfway, the normal view will return for [**Smooth zone**]. For [**Live 1-point AF**], AF will proceed with the magnified view.
- With Servo AF, if you press the shutter button halfway in the magnified view, the camera will return to the normal view for focusing.

- If focusing is difficult in the magnified view, return to the normal view and perform AF.
- If you perform AF in the normal view and then use the magnified view, accurate focus may not be achieved.
- AF speed differs between normal view and magnified view.
- When in magnified view, Movie Servo AF (p.373) will not function.
- With the magnified view, achieving focus becomes more difficult due to camera shake. Using a tripod is recommended.

# Shooting with the Touch Shutter

Just by tapping on the LCD monitor screen, you can focus and take the picture automatically.



## 1 Display the Live View image.

- Press the < START/STOP > button.
- ▶ The Live View image will appear on the LCD monitor.





## 2 Enable the Touch Shutter.





- Tap [OFF] on the screen's bottom left. Each time you tap on the icon, it will toggle between [OFF] and [ON].
- [ON] (Touch Shutter: Enable)  
The camera will focus on the spot you tap on, then the picture will be taken.
- [OFF] (Touch Shutter: Disable)  
You can tap on a spot to perform focusing on the spot. Press the shutter button completely to take the picture.



## 3 Tap on the screen to shoot.

- Tap on the face or subject on the screen.
- ▶ On the point you tap, the camera will focus (Touch AF) with the AF method that was set (p.308-314).
- ▶ When [ON] is set, the AF point turns green when focus is achieved, then the picture is taken automatically.
- ▶ If focus is not achieved, the AF point turns orange and the picture cannot be taken. Tap on the face or subject on the screen again.

- Even if you set the drive mode to <img alt="Single frame icon" data-bbox="100 105 125 130"/>H> or <img alt="Single frame icon" data-bbox="100 135 125 160"/>, the camera will still shoot in the single shooting mode.
- Even if [AF operation] is set to [Servo AF], tapping on the screen will focus on the image with [One-Shot AF].
- Tapping on the screen in magnified view will not focus or take the picture.
- If you shoot by tapping on the screen with [ 1: Image review] set to [Hold], you can press the shutter button halfway to take the next shot.
- If you use [ C.Fn III-4: Custom Controls] to assign a button with [ONE SHOT ⇄ AI SERVO/SERVO] or the function that activates the metering timer (p.497), Touch Shutter shooting is not possible while you keep holding down the respective button.

- You can also set the Touch Shutter with [ 5: Touch Shutter] (the [ 2] tab in Basic Zone modes).
- With [ 5: AF method] set to [Smooth zone] and [] (Touch Shutter: Enable) set, tapping the screen will focus with [Live 1-point AF] and take the picture.
- To shoot with bulb exposure, tap on the screen twice. The first tap on the screen will start the bulb exposure. Tapping it again will stop the bulb exposure. Be careful not to shake the camera when tapping on the screen.

# MF: Focusing Manually

You can magnify the image and focus precisely with MF (manual focus).

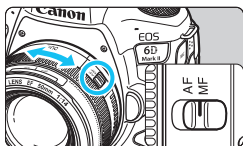

## 1 Set the lens's focus mode switch to <MF>.

- Turn the lens focusing ring to focus roughly.



## 2 Display the magnifying frame.

- Press the <Q> button or tap on [Q] on the lower right of the screen.
- ▶ The magnifying frame will appear.

Magnifying frame

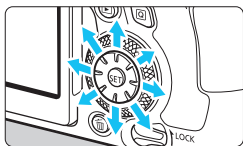

## 3 Move the magnifying frame.

- Either operate <⬇️> or tap on the spot you want to magnify to move the magnifying frame to where you want to focus.
- Pressing the <SET> or <🗑️> button will return the magnifying frame to the screen center.



AE lock

Magnified area position

Magnification (Approx.)

## 4 Magnify the image.

- Each time you press the <Q> button or tap on [Q] on the lower right of the screen, the screen will change in the following sequence:

→ Normal view → 1x → 5x → 10x →

- While in magnified view, you can use <⬆️> or tap on the triangle on the top, bottom, left, or right of the screen to scroll around the magnified image.

## 5 Focus manually.

- While looking at the magnified image, turn the lens focusing ring to focus.
- After achieving focus, press the <Q> button to return to the normal view.

## 6 Take the picture.

- Check the exposure, then press the shutter button completely to take the picture (p.290).



- In magnified view, the exposure is locked. (Shutter speed and aperture will be displayed in red.)
- Even with manual focusing, you can use the Touch Shutter to take a picture.









## General Live View Shooting Cautions

### Image Quality

- When you shoot at high ISO speeds, noise (such as dots of light and banding) may become noticeable.
- Shooting in high temperatures may cause noise and irregular colors in the image.
- If Live View shooting is used continuously for a prolonged period, the camera's internal temperature may rise, and image quality may deteriorate. Always exit Live View shooting when you are not shooting.
- If you shoot a long exposure while the camera's internal temperature is high, image quality may deteriorate. Exit Live View shooting and wait a few minutes before shooting again.

### White and Red Internal Temperature Warning Icons

- If the camera's internal temperature increases due to prolonged Live View shooting or a high ambient temperature, a white  or red  icon will appear.
- The white  icon indicates that the image quality of still photos will deteriorate. It is recommended that you temporarily exit Live View shooting and allow the camera to cool down before shooting again.
- The red  icon indicates that the Live View shooting will soon stop automatically. If this happens, you will not be able to shoot again until the camera's internal temperature decreases. Temporarily exit the Live View shooting or turn off the power and let the camera rest for a while.
- Using Live View shooting at a high temperature for a prolonged period will cause a white  or red  icon to appear earlier. When you are not shooting, always turn off the camera.
- If the camera's internal temperature is high, the quality of images shot with a high ISO speed or long exposure may deteriorate even before the white  icon is displayed.

### Shooting Results

- In magnified view, the shutter speed and aperture will be displayed in red. If you take the picture in magnified view, the exposure may not come out as desired. Return to the normal view before taking the picture.
- Even if you take the picture in magnified view, the image will be captured with the image area of the normal view.



## General Live View Shooting Cautions

### Live View Image

- Under low- or bright-light conditions, the Live View image may not reflect the brightness of the captured image.
- Even if a low ISO speed is set, noise may be noticeable in the displayed Live View image under low light. However, when you shoot, the image recorded will have less noise. (The image quality of the Live View image is different from that of the recorded image.)
- If the light source (illumination) within the image changes, the screen may flicker. If this happens, exit Live View shooting and resume Live View shooting under the actual light source.
- If you point the camera in a different direction, it may throw off the Live View image's correct brightness momentarily. Wait until the brightness level stabilizes before shooting.
- If there is a very bright light source in the image, the bright area may appear black on the LCD monitor. However, the actual captured image will correctly show the bright area.
- In low light, if you set the [**42: LCD brightness**] to a bright setting, noise or irregular colors may appear in the Live View image. However, the noise or irregular colors will not be recorded in the captured image.
- When you magnify the image, the image sharpness may look more pronounced than in the actual image.

### Custom Functions

- During Live View shooting, certain Custom Functions will not work (certain settings become invalid). For details, see page 469.

### Lens and Flash

- If the attached lens has an Image Stabilizer and you set the Image Stabilizer (IS) switch to <ON>, the Image Stabilizer will operate at all times even if you do not press the shutter button halfway. The Image Stabilizer consumes battery power and may decrease the number of possible shots depending on the shooting conditions. When the Image Stabilizer is not necessary, such as when using a tripod, it is recommended that you set the IS switch to <OFF>.
- The focus preset function is possible for Live View shooting only when using a (super) telephoto lens equipped with the focus preset mode released in and after the second half of 2011.
- FE lock and modeling flash will not work if an external Speedlite is used.



# 9

## Shooting Movies

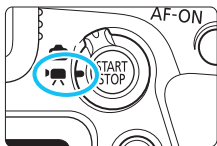

Movie shooting is enabled by setting the Live View shooting/Movie shooting switch to <  >.

- **Before shooting movies, see page 343 and make sure the card is able to record movies at the desired movie-recording quality setting.**
- If you handhold the camera and shoot movies, camera shake can cause blurred movies. Using a tripod is recommended in such cases.
- For instructions on how to hold the camera, see page 99.



### Full HD 1080

Full HD 1080 indicates compatibility with High-Definition featuring 1080 vertical pixels (scanning lines).



# Shooting Movies

## Autoexposure Shooting

When the shooting mode is set to  $\langle A^+ \rangle$ ,  $\langle CA \rangle$ ,  $\langle P \rangle$ ,  $\langle Tv \rangle$ ,  $\langle Av \rangle$ , or  $\langle B \rangle$ , autoexposure control will take effect to suit the scene's current brightness.

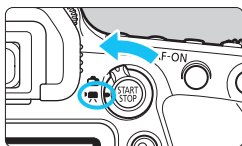

### 1 Set the Live View shooting/Movie shooting switch to $\langle \text{Movie} \rangle$ .

- ▶ The Live View image will appear on the LCD monitor.

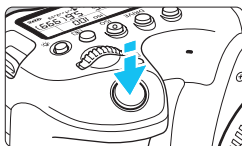

### 2 Set the Mode Dial to $\langle A^+ \rangle$ , $\langle CA \rangle$ , $\langle P \rangle$ , $\langle Tv \rangle$ , $\langle Av \rangle$ , or $\langle B \rangle$ .

### 3 Focus on the subject.

- Before shooting a movie, focus with AF or manual focus (p.308, 321).
- By default, [ **4: Movie Servo AF** ] is set to [ **Enable** ] so that the camera always keeps focusing (p.373).
- When you press the shutter button halfway, the camera will focus with the current AF method.

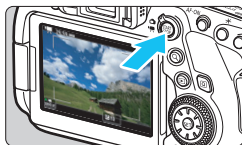

### 4 Shoot the movie.

- Press the  $\langle \text{START STOP} \rangle$  button to start shooting a movie.
- ▶ While the movie is being shot, the “●” mark will be displayed on the upper right of the screen.
- ▶ Stereo sound is recorded by the built-in microphones.
- To stop shooting the movie, press the  $\langle \text{START STOP} \rangle$  button again.

Recording movie

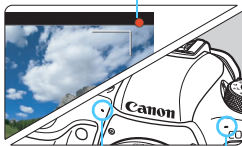



Built-in microphones

## ISO Speed in the <A+> and <CA> Modes

- The ISO speed will be set automatically within ISO 100 - ISO 25600.

## ISO Speed in the <P>, <Tv>, <Av>, and <B> Modes

- The ISO speed will be set automatically within ISO 100 - ISO 25600.
- Under [ 2:  ISO speed settings], if you set [ISO Auto] to [Max.:H2 (102400)] (p.372), the maximum limit of the automatic ISO speed setting range will be expanded to H2 (equivalent to ISO 102400). If you select [Max.:6400] or [Max.:12800], you can narrow the automatic ISO speed setting range (maximum limit is lowered).
- If [ 3: Highlight tone priority] is set to [Enable] (p.199), the automatic ISO speed setting range's minimum limit will be ISO 200. Also, even if [ISO Auto] is set to [Max.: H1 (51200)] or [Max.: H2 (102400)], the maximum limit will not be expanded.

- When the <SCN> mode is set, HDR movie shooting takes effect (p.348).
- Even if you set the <Tv> or <Av> mode, movie shooting with priority given to shutter speed or aperture cannot be performed. Autoexposure shooting takes effect as in the <P> mode.
- For movie shooting, the ISO speed cannot be expanded to L (equivalent to ISO 50).
- When switching from still photo shooting to movie shooting, check the camera settings again before shooting movies.
- Regarding the ISO speed for time-lapse movie shooting, see page 354 and 372.

 **Cautions for the <A+>, <CA>, <P>, <Tv>, <Av>, and <B> Modes**

- In the <A+> and <CA> modes, the scene icon for the scene detected by the camera is displayed on the upper left of the screen (p.329).
- You can lock the exposure (AE lock) by pressing the <★> button (except in the <A+>, <CA> and <SCN> modes, p.249). After applying AE lock during movie shooting, you can cancel it by pressing the <⏏> button. (AE lock setting is retained until you press the <⏏> button.)
- You can set exposure compensation up to ±3 stops by setting the <LOCK> switch downward and turning the <⦿> dial (except in the <A+>, <CA>, and <SCN> modes).
- The ISO speed, shutter speed, and aperture will not be recorded in the movie's Exif information.
- With autoexposure movie shooting (except in time-lapse movie shooting), this camera supports the Speedlite's function to turn on the LED light automatically in low-light conditions. For details, refer to the Instruction Manual of the EX-series Speedlite equipped with an LED light.

## Scene Icons

In the <A+> and <CA> modes, the camera detects the scene type and sets the exposure automatically to suit the scene. The detected scene type is indicated on the upper left of the screen.

Subject Background	Portrait <sup>*1</sup>	Non-Portrait		Background Color
		Nature and Outdoor Scene	Close <sup>*2</sup>	
Bright				Gray
Backlit				
Blue Sky Included				Light blue
Backlit				
Sunset	*3		*3	Orange
Spotlight				Dark blue
Dark				

\*1: Displayed only when the AF method is set to [Tracking]. If another AF method is set, the "Non-portrait" icon will be displayed even if a person is detected.

During time-lapse movie shooting, the "Non-portrait" icon will be displayed even if a person is detected.

\*2: Displayed when the attached lens has distance information. With an extension tube or close-up lens, the icon displayed may not match the actual scene.

\*3: The icon of the scene selected from the detectable scenes will be displayed.

For certain scenes or shooting conditions, the icon displayed may not match the actual scene.

## M Manual Exposure Shooting

You can manually set the shutter speed, aperture, and ISO speed for movie shooting. Using manual exposure to shoot movies is for advanced users.

**1 Set the Live View shooting/Movie shooting switch to <Movie>.**



**2 Set the Mode Dial to <M>.**



**3 Set the ISO speed.**

- Press the <ISO> button.
- ▶ The ISO speed setting screen will appear on the LCD monitor.
- Turn the <ISO> or <ISO> dial to set it.
- For details on the ISO speed, see the next page.



Shutter speed

**4 Set the shutter speed and aperture.**

- Press the shutter button halfway and check the exposure level indicator.
- To set the shutter speed, turn the <Shutter> dial. To set the aperture, turn the <Aperture> dial.
- The settable shutter speeds vary depending on the frame rate. See page 333.

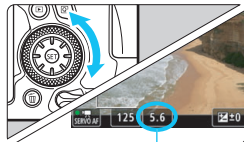

Aperture





**5 Focus and shoot the movie.**

- The procedure is the same as steps 3 and 4 for “Autoexposure Shooting” (p.326).

## ISO Speed in the <M> Mode

- With **[AUTO] (A)**, the ISO speed will be set automatically within ISO 100 - ISO 25600. Under **[CAMERA 2: Shooting ISO speed settings]**, if you set **[ISO Auto]** to **[Max.:H2 (102400)]** (p.372), the maximum limit of the automatic ISO speed setting range will be expanded to H2 (equivalent to ISO 102400). If you select **[Max.:6400]** or **[Max.:12800]**, you can narrow the automatic ISO speed setting range (maximum limit is lowered).
- You can set the ISO speed manually within ISO 100 - ISO 25600 in 1/3-stop increments. Under **[CAMERA 2: Shooting ISO speed settings]**, if you set **[Maximum]** to **[H2 (102400)]** for **[ISO speed range]** (p.372), the maximum limit for the manual ISO speed setting range will be expanded to H2 (equivalent to ISO 102400). Note that you can also set the **[Maximum]** and **[Minimum]** to a range narrower than the default range (ISO 100 - ISO 25600).
- If **[CAMERA 3: Highlight tone priority]** is set to **[Enable]** (p.199), the automatic and manual ISO speed setting range's minimum limit will be ISO 200. Also, even if the ISO speed's maximum limit is set to be expanded to **[H1 (ISO 51200)]** or **[H2 (ISO 102400)]**, the maximum limit will not be expanded.

- For movie shooting, the ISO speed cannot be expanded to L (equivalent to ISO 50).
- When switching from still photo shooting to movie shooting, check the camera settings again before shooting movies.
- During movie shooting, avoid changing the shutter speed or aperture. Doing so may record the changes in the exposure or create more noise at high ISO speeds.
- When shooting a movie of a moving subject, a shutter speed of approx. 1/25 sec. to 1/125 sec. is recommended. The faster the shutter speed, the less smooth the subject's movement will look.
- If you change the shutter speed while shooting under fluorescent or LED lighting, image flicker may be recorded.
- Regarding the ISO speed for time-lapse movie shooting, see page 354.

- In step 4, if you cannot set the shutter speed or aperture, set the <LOCK> switch downward and turn the  or  dial.
- Under [ **C.Fn III-4: Custom Controls**], if [ **Expo comp (hold btn, turn **)] is set (p.502), you can set exposure compensation with ISO Auto set.
- When ISO Auto is set, you can press the <★> button to lock the ISO speed. After locking the ISO speed during movie shooting, you can cancel it by pressing the <☒> button. (ISO speed lock is maintained until you press the <☒> button.)
- If you press the <★> button and recompose the shot, you can see the exposure level difference on the exposure level indicator compared to when the <★> button was pressed.
- With the camera ready to shoot in the <M> mode, you can display the histogram by pressing the <INFO> button.



## Settable Shutter Speeds

The settable shutter speeds in the <M> manual exposure shooting mode vary depending on the frame rate of the movie recording quality.  
(sec.)

Frame Rate	Shutter Speed
59.94P	1/4000 - 1/60
50.00P	1/4000 - 1/50
29.97P	1/4000 - 1/30
25.00P 23.98P	1/4000 - 1/25

 The settable shutter speeds will differ for time-lapse movie shooting (p.349).

## Still Photo Shooting

**Still photos cannot be taken during movie shooting.** To take still photos, stop the movie shooting and take still photos using viewfinder shooting or Live View shooting.

## Information Display

Each time you press the <INFO> button, the information display will change.

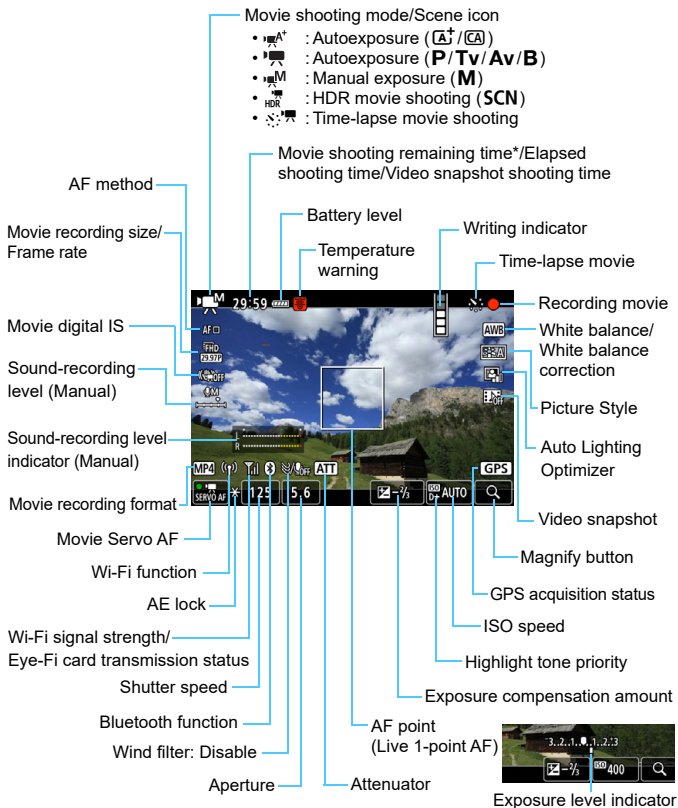

\* Applies to a single movie clip.

● The display will show only the settings currently applied.



- When the [CAMERA 4: AF method] is [Smooth zone] or [Live 1-point AF], you can press the <INFO> button to display the electronic level (p.80).
- You can set what is displayed for when you press the <INFO> button (p.298).
- If [CAMERA 4: AF method] is set to [L+Tracking] or if the camera is connected to a TV set with an HDMI cable, the electronic level cannot be displayed.
- The electronic level, grid lines, or histogram cannot be displayed during movie shooting. (The display will disappear when you start shooting a movie.)
- When movie shooting starts, the movie shooting remaining time will change to the elapsed time.

## Cautions for Movie Shooting

- Do not point the camera toward an intense light source, such as the sun or an intense artificial light source. Doing so may damage the image sensor or the camera's internal components.
- If you shoot something that has fine detail, moire or false colors may result.
- If <AWB> or <AWB w> is set and the ISO speed or aperture changes during movie shooting, the white balance may also change.
- If you shoot a movie under fluorescent or LED lighting, the movie image may flicker.
- If you perform AF with a USM lens during movie shooting in low light, horizontal banding noise may be recorded in the movie. The same type of noise may occur if you focus manually with certain lenses equipped with an electronic focusing ring.
- Shooting a few test movies is recommended if you intend to perform zooming during movie shooting. Zooming during movie shooting may result in recording of changes in exposure or mechanical sound of the lens, or images may be out of focus.
- During movie shooting, if you perform AF, any of the following may occur: The focus is temporarily greatly thrown off, changes in movie brightness is recorded, the movie recording stops momentarily, and the mechanical sound of the lens is recorded.
- During movie shooting, you cannot magnify the image even if you press the <Q> button.
- Be careful not to cover the built-in microphones (p.326) with your fingers, etc.
- If you connect or disconnect the HDMI cable during movie shooting, the movie shooting will end.
- **“General Movie Shooting Cautions” are on pages 382-383.**
- **If necessary, also read “General Live View Shooting Cautions” on pages 323-324.**











### Warnings

**Do not hold the camera in the same position for long periods of time.**

Even if the camera does not feel too hot, prolonged contact with the same body part may cause skin redness or blistering due to low-temperature contact burns. Using a tripod is recommended when using the camera in very hot places or for people with circulation problems or poor skin sensation.



### Notes for Movie Shooting

- Each time you shoot a movie, a new movie file is created on the card.
- The movie's field of view coverage for shooting Full HD and HD movies is approx. 100%.
- You can also focus by pressing the <AF-ON> button.
- With [/AF] or [/AF] selected under [4:  btn function], you can press the shutter button completely to start or stop the movie shooting (p.378, under the [2] tab in Basic Zone modes).
- Stereo sound is recorded by the camera's built-in microphones (p.326).
- If you connect the Directional Stereo Microphone DM-E1 (sold separately) to the camera's external microphone IN terminal (p.29), the external microphone is given the priority (p.347).
- Most external microphones equipped with a 3.5 mm diameter mini plug can be used.
- With a fully-charged Battery Pack LP-E6N, the possible movie shooting time will be as follows: approx. 2 hr. 40 min. at room temperatures (23°C / 73°F) and approx. 2 hr. 20 min. at low temperatures (0°C / 32°F) (with [1: Movie rec. size]:  29.97P  23.98P  and [4: Movie Servo AF: Disable] set).
- The focus preset function can be used for movie shooting when using a (super) telephoto lens equipped with the focus preset mode, released in and after the second half of 2011.
- The color sampling recorded will be YCbCr 4:2:0 (8-bit), and the color matrix recorded will be Rec. ITU-R BT.709.

## Final Image Simulation

Final image simulation is a function that shows the movie as it will look with the current settings for the Picture Style, white balance and other shooting functions applied.

During movie shooting, the image will automatically reflect the function settings listed below. However, the displayed image may be slightly different from the resulting image.

### Final Image Simulation for Movie Shooting

- Picture Style
  - \* Sharpness (Strength), contrast, color saturation, and color tone will be reflected.
- White balance
- White balance correction
- Exposure
- Depth of field (except during the time-lapse movie shooting)
- Auto Lighting Optimizer
- Peripheral illumination correction
- Chromatic aberration correction
- Highlight tone priority
- HDR movie

ⓘ During time-lapse movie shooting, if the exposure is not being simulated correctly, the <Exp.SIM> icon will blink.

# Shooting Function Settings

## AF/ISO Settings

With the image displayed on the LCD monitor, if you press the <AF> or <ISO> button, the setting screen will appear on the LCD monitor and you can turn the <☀> dial to set the respective function.

- During manual-exposure shooting (p.330), you can press the <ISO> button to set the ISO speed.
- You cannot set the AF operation, drive mode, or metering mode.

## Q Quick Control

With the image displayed on the LCD monitor, you can press the <Q> button to set the following functions.

In Creative Zone modes, you can set the following: **AF method**, **Movie recording size**, **Movie digital IS**, Sound-recording level (only when set manually), White balance, Picture Style, Auto Lighting Optimizer, and **Video snapshots**.

In the <A+> or <CA> mode, only the functions in bold above can be set. For <SCN> mode, only the AF method can be set.





1 Press the <Q> button (☉10).

- ▶ The settable functions will be displayed.

## 2 Select a function and set it.

- Press the <▲> <▼> keys to select a function.
- ▶ The settings of the selected function and Feature guide will appear on the screen.
- Turn the <☀> or <☾> dial to set it.
- To set the white balance correction or Picture Style parameters, press the <INFO> button.
- To set Auto white balance, select [AWB] (or [AWB w]), then press <SET>.
- To return to movie shooting, press <SET> or the <Q> button.
- You can also select [↶] to return to movie shooting.

 With [📷1: Sound recording] set to [Manual] and [📷5: Time-lapse movies] set to [Enable], pressing the <Q> button will not display the sound-recording level (only when set manually).

 During movie shooting, you can press the <Q> button to set the sound-recording level (only when set manually).



## MENU Setting the Movie Recording Quality

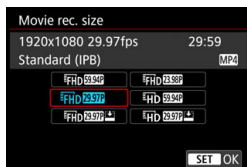

With [**1: Movie rec. size**], you can set the movie recording quality (image size, frame rate, and compression method). The movie will be recorded as an MP4 file.

The frame rate displayed on the [**1: Movie rec. size**] screen switches automatically depending on the [**3: Video system**] setting (p.541).

**The card's writing and reading speeds required for recording movies vary depending on the movie recording quality. Before shooting movies, see page 343 to check the performance requirements of the card.**

### Movie Recording Size

#### ● Image size

##### **FHD 1920x1080**

The movie will be recorded in Full High-Definition (Full HD) quality. The aspect ratio is 16:9.

##### **HD 1280x720**

The movie will be recorded in High-Definition (HD) quality. The aspect ratio is 16:9.

- If you change the [**3: Video system**] setting, also set [**1: Movie rec. size**] again.
- You cannot shoot Standard Definition (VGA) movies.

- **Frame rate** (fps: frame per second)

**59.94P** **59.94fps**/**29.97P** **29.97fps**

For areas where the TV system is NTSC (North America, Japan, South Korea, Mexico, etc.).

**50.00P** **50.00 fps**/**25.00P** **25.00 fps**

For areas where the TV system is PAL (Europe, Russia, China, Australia, etc.).

**23.98P** **23.98 fps**

Selectable when [**3: Video system**] is set to [**For NTSC**].  
Mainly for motion pictures.

- **Compression method**

**IPB** **IPB** (Standard)

Compresses multiple frames at a time efficiently for recording.

**IPB** **IPB** (Light)

Since the movie is recorded at a bit rate lower than with IPB (Standard), the file size will be smaller than with IPB (Standard) and the playback compatibility will be higher. This will make the possible shooting time longer than with IPB (Standard) (with a card having the same capacity).

- **Movie recording format**

**MP4** **MP4**

The movie will be recorded in the MP4 format (file extension “.MP4”). This file format provides higher compatibility for playback than with MOV.

## Cards that Can Record Movies

When shooting movies, use a large-capacity card with a writing/reading speed (required card performance) shown in the table below or higher than the standard specification. Test the card by taking a few movies in the desired quality (p.341) and make sure the card can properly record the movie.

Movie Recording Quality				SD Card
<b>Normal movie</b>				
FHD	59.94P 50.00P	IPB	MP4	SD Speed Class 10 or higher
	29.97P 25.00P 23.98P			HDR movies
	29.97P 25.00P	IPB		SD Speed Class 4 or higher
HD	59.94P 50.00P	IPB		SD Speed Class 6 or higher
	29.97P 25.00P	IPB		SD Speed Class 4 or higher
<b>Time-lapse movie (p.349)</b>				
4K	29.97P 25.00P	MJPG	MOV	UHS-I 90 MB/sec. or faster
FHD		ALL-I		UHS-I Speed Class 3 or higher

\* The required card performance for time-lapse movies applies to reading speed.



- If you use a slow-writing card when shooting movies, the movie may not be recorded properly. Also, if you play back a movie on a card with a slow reading speed, the movie may not be played back properly.
- When movies cannot be recorded normally, format the card and try again. If formatting the card does not resolve the problem, refer to the card manufacturer's Web site, etc.
- The camera is not compatible with UHS-II, the ultra high speed transfer standard of SDHC/SDXC cards. (Compatible with UHS-I.) With a UHS-II-compatible card, high-speed transfer via UHS-I may not be possible depending on the card specification.

- To obtain better performance with the card, formatting the card with the camera before shooting movies is recommended (p.75).
- To check the card's writing/reading speed, refer to the card manufacturer's Web site, etc.
- For bit rates, see page 574.

## Total Movie Recording Time and File Size Per Minute

### ● Normal movie (Approx.)

Movie Recording Quality	Total Possible Recording Time on Card			File Size	
	8 GB	32 GB	128 GB		
<b>FHD : Full HD movie</b>					
59.94P 50.00P	IPB	17 min.	70 min.	283 min.	431 MB/min.
29.97P 25.00P 23.98P		35 min.	140 min.	563 min.	216 MB/min.
HDR Movie		35 min.	140 min.	563 min.	216 MB/min.
29.97P 25.00P	IPB ↓	86 min.	347 min.	1391 min.	87 MB/min.
<b>HD : HD movie</b>					
59.94P 50.00P	IPB	40 min.	162 min.	649 min.	184 MB/min.
29.97P 25.00P	IPB ↓	250 min.	1001 min.	4004 min.	30 MB/min.

### ● Time-lapse movie (Approx.)

Movie Recording Quality	Total Possible Recording Time on Card			File Size	
	8 GB	32 GB	128 GB		
<b>4K : 4K Time-lapse movie</b>					
29.97P 25.00P	MJPG	2 min.	8 min.	34 min.	3576 MB/min.
<b>FHD : Full HD Time-lapse movie</b>					
29.97P 25.00P	ALL-I	11 min.	47 min.	189 min.	643 MB/min.

\* For the movie recording time (playback time) for time-lapse movie shooting, see page 351.

**!** An increase of the camera's internal temperature may cause movie shooting to stop before the total recording time shown in the table (p.382).

## Movie Files Exceeding 4 GB

Even if you shoot a movie exceeding 4 GB, you can keep shooting without interruption (except the time-lapse movie shooting).

- **Using SD/SDHC cards formatted with the camera**

If you use the camera to format an SD/SDHC card, the camera will format it in FAT32.

With a FAT32-formatted card, if you shoot a movie and the file size exceeds 4 GB, a new movie file will be created automatically. When you play back the movie, you will have to play back each movie file individually. Movie files cannot be played back automatically in consecutive order. After the movie playback ends, select the next movie and play it back.

- **Using SDXC cards formatted with the camera**

If you use the camera to format an SDXC card, the camera will format it in exFAT.

When using an exFAT-formatted card, even if the file size exceeds 4 GB during movie shooting, the movie will be saved as a single file (rather than being split into multiple files).

## Movie Shooting Time Limit

The maximum recording time of one movie clip is 29 min. 59 sec. If the movie shooting time reaches 29 min. 59 sec., the movie shooting will stop automatically. You can start shooting a movie again by pressing the <  > button. (The movie will be recorded as a new movie file.)



- When downloading movie files exceeding 4 GB to a computer, use either the EOS Utility (p.594) or a card reader (p.599). Movie files exceeding 4 GB will not be downloaded if you perform image download with the computer's operating system.
- For 4K time-lapse movie shooting (p.350), using an SDXC card is recommended.

## MENU Setting the Sound Recording

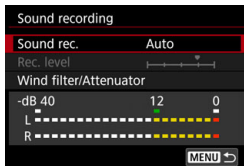

You can shoot movies while recording sound with the built-in stereo microphones or an external stereo microphone. You can also freely adjust the sound-recording level.

Use [**1: Sound recording**] to set sound recording functions.

### Sound Recording/Sound-Recording Level

**Auto** : The sound-recording level is adjusted automatically. Auto level control will take effect automatically in response to the sound level.

**Manual** : For advanced users. You can adjust the sound-recording level to one of 64 levels.

Select [**Rec. level**] and press the <◀> <▶> keys while looking at the level meter to adjust the sound-recording level. Look at the peak hold indicator, and adjust so that the level meter sometimes lights up on the right of the “12” (-12 dB) mark for the loudest sounds. If it exceeds “0”, the sound will be distorted.

**Disable** : Sound will not be recorded.

### Wind Filter

When set to [**Auto**], it reduces wind noise when there is wind outdoors. This feature works only when you use the built-in microphones for movie shooting. When the wind filter function takes effect, part of the low bass sounds will also be reduced.

## Attenuator

Automatically suppresses sound distortion caused by loud noises. Even if [Sound rec.] is set to [Auto] or [Manual] for shooting, sound distortion may still result if there is a very loud sound. In such a case, setting it to [Enable] is recommended.

### ● Using a microphone

Normally, the built-in microphones will record the sound in stereo. If an external stereo microphone equipped with a miniature stereo plug (3.5 mm diameter) is connected to the camera's external microphone IN terminal (p.29), the external microphone will be given the priority. Using the Directional Stereo Microphone DM-E1 (sold separately) is recommended.



- If you use the Wi-Fi (wireless communication) function with an external microphone, the sound noise may be recorded. During sound recording, using the wireless communication function is not recommended.
- The camera's built-in microphones will also record the operation sound and mechanical sound of the camera during shooting. Using Directional Stereo Microphone DM-E1 (sold separately) may reduce such sounds in the movie.
- When connecting an external microphone to the camera, be sure to insert the plug all the way in.
- Do not connect anything other than an external microphone to the camera's external microphone IN terminal.



- In Basic Zone modes, the settings available for [Sound recording] will be [On] or [Off]. If [On] is set, the sound-recording level will be adjusted automatically (same as with [Auto]), and the wind filter function will take effect.
- The sound volume balance between L (left) and R (right) cannot be adjusted.
- Sound is recorded at a 48 kHz/16-bit sampling rate.

# Shooting HDR Movies

If you set the Mode Dial to <SCN>, you can shoot movies with clipped highlights reduced for a high dynamic range of tones even in high-contrast scenes.

HDR movie will be recorded in **FHD 29.97P IPB** (NTSC) or **FHD 25.00P IPB** (PAL).

\* HDR stands for High Dynamic Range.



## 1 Set the Mode Dial to <SCN>.



## 2 Shoot an HDR movie.

- Shoot the movie in the same way as normal movie shooting.

Since multiple frames are merged to create an HDR movie, certain parts of the movie may look distorted. During handheld shooting, camera shake may make the distortion look more noticeable. Using a tripod is recommended. Note that even if a tripod is used for shooting, afterimages or noise may become more noticeable when the HDR movie is played back frame-by-frame or in slow-motion compared to normal playback.



## Shooting Time-lapse Movies

Still photos shot at a set interval can be stitched together automatically to create a 4K or Full HD time-lapse movie. A time-lapse movie shows how a subject changes in a much shorter period of time than the actual time it took. It is effective for a fixed-point observation of changing scenery, growing plants, celestial motion, etc.

Time-lapse movies will be recorded in the MOV format at the following quality: **4K 29.97P [MJPEG] (NTSC)** / **4K 25.00P [MJPEG] (PAL)** for 4K, and **FHD 29.97P [ALL-I] (NTSC)** / **FHD 25.00P [ALL-I] (PAL)** for Full HD.

Note that the frame rate will be switched automatically according to the [**3**: Video system] setting (p.541).

### 1 Select a shooting mode.

- As with normal movie shooting, in the **<A+>**, **<CA>**, **<P>**, **<Tv>**, **<Av>**, and **<B>** modes, autoexposure shooting takes effect. In the **<M>** mode, manual exposure shooting takes effect.

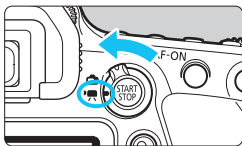

### 2 Set the Live View shooting/Movie shooting switch to **<L>**.

- The Live View image will appear on the LCD monitor.

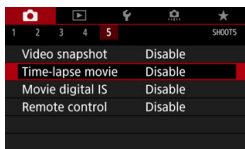

### 3 Select [Time-lapse movie].

- Under the [**5**] tab (the [**3**] tab in **<A+>** and **<CA>** modes), select [Time-lapse movie], then press **<SET>**.

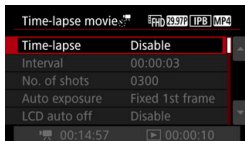

### 4 Select [Time-lapse].

Even if you set the **<Tv>** or **<Av>** mode, time-lapse movie shooting with priority given to shutter speed or aperture cannot be performed. Autoexposure shooting takes effect as in the **<P>** mode.

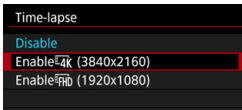

## 5 Select the desired movie recording size.

- Select [Enable 4K (3840x2160)] or [Enable FHD (1920x1080)].

- **Enable 4K (3840x2160)**

The movie is recorded in 4K quality. The aspect ratio is 16:9. The frame rate of the recorded movie is 29.97fps (29.97P) for NTSC and 25.00fps (25.00P) for PAL, and its recording format is Motion JPEG (MJPG) and its movie file format is MOV (MOV).

- **Enable FHD (1920x1080)**

The movie is recorded in Full High-Definition (Full HD) quality. The aspect ratio is 16:9. The frame rate of the recorded movie is 29.97fps (29.97P) for NTSC and 25.00fps (25.00P) for PAL, and its recording format is ALL-I (ALL-I), and its movie file format is MOV (MOV).

- **Movie recording method / Compression rate**

**MJPG MJPG**

Each frame is compressed one at a time and recorded. The compression rate is low, but the movie is better suited for editing.

**ALL-I ALL-I** (For editing/I-only)

Each frame is compressed one at a time and recorded. The compression rate is low, but the movie is better suited for editing than with IPB.

- **Movie recording format**

**MOV MOV**

The movie is recorded in the MOV format (file extension “.MOV”).

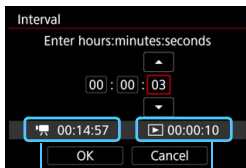

Time required Playback time

## 6 Set the shooting interval.

- Select [Interval].
- Check the [Time required] and [Playback time] displayed at the bottom of the screen to set the number.
- Select the hour, minute, or second.
- Press <SET> to display <⏏>.

- Set the desired number, then press <SET>. (Returns to <□>.)
- Settable in the range from [00:00:01] to [99:59:59].
- Select [OK] to set the shooting interval.

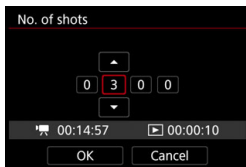

## 7 Set the number of shots.

- Select [No. of shots].
- Check the [Time required] and [Playback time] displayed at the bottom of the screen to set the number.
- Select the digit.

- Press <SET> to display <⏏>.
- Set the desired number, then press <SET>. (Returns to <□>.)
- Settable in the range from [0002] to [3600].
- Check that [Playback time] is not displayed in red.
- Select [OK] to set the number of shots.



- For cards that can record time-lapse movies (card performance requirements), see page 343.
- If the number of shots is set to 3600, the time-lapse movie will be approx. 2 min. in NTSC and approx. 2 min. 24 sec. in PAL.



## 8 Select the exposure's setting method.

- Select [**Auto exposure**].

### • Fixed 1st frame

When taking the first shot, metering is performed to set the exposure automatically to match the brightness. The exposure setting for the first shot will be applied to subsequent shots. Other shooting-related settings for the first shot will also be applied for subsequent shots.

### • Each frame

Metering is also performed for each subsequent shot to set the exposure automatically to match the brightness. Note that if functions such as Picture Style and white balance are set to [**Auto**], they will be set automatically for each subsequent shot.

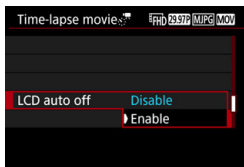

## 9 Set whether the image is to be displayed.

- Select [**LCD auto off**].

### • Disable

Even during time-lapse movie shooting, the image will be displayed. (The LCD monitor turns off only at the time of shooting.) Note that the LCD monitor will turn off when approx. 30 min. elapse after the shooting started.

### • Enable

The LCD monitor will turn off when approx. 10 sec. elapse after the shooting started.

 During time-lapse movie shooting, you can press the <INFO> button to turn on/off the LCD monitor.

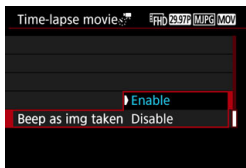

## 10 Set the beeper.

- Select **[Beep as img taken]**.
- If **[Disable]** is set, the beeper will not sound for shooting.



## 11 Check the settings.

Time required    Playback time

### ● Time required

Indicates the time required to shoot the set number of shots with the set interval. If it exceeds 24 hours, “\*\*\* days” will be displayed.

### ● Playback time

Indicates the movie recording time (time required to play back the movie) when creating the time-lapse movie in 4K movie or Full HD movie from the still photos taken with the set intervals.

## 12 Exit the menu.

- Press the **<MENU>** button to turn off the menu screen.



If [**4: Beep**] is set to **[Disable]**, the setting in step 10 cannot be set.

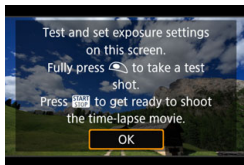

### 13 Read the message.

- Read the message and select [OK].

### 14 Take test shots.

- As with Live View shooting, set the exposure and shooting functions, then press the shutter button halfway to focus.
- Press the shutter button completely to take test shots. The still photos will be recorded to the card.
- If there are no problems with the test shots, go to the next step.
- To take test shots again, repeat this step.

- The test shots are recorded with the [📷1: Movie rec. size] setting.
- In the <M> mode, you can set the shutter speed within a range of 1/4000 sec. to 30 sec.
- With autoexposure shooting (except for the <A+> and <CA> modes) or manual exposure shooting + ISO Auto, the maximum limit of the ISO speed set automatically can be set with [📷: ISO Auto] under [📷2: ISO speed settings] (p.372).
- For manual exposure shooting, if you set [Maximum] for [ISO speed range] to [H2(102400)] under [📷2: ISO speed settings], the maximum limit of the manual setting range will be expanded to H2 (equivalent to ISO 102400).



## 15 Press the <START/STOP> button.

- ▶ The camera will be ready to start shooting a time-lapse movie.
- To return to step 13, press the <START/STOP> button again.

Number of shots

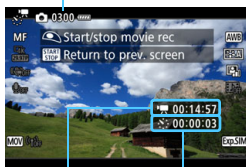

Time required

Interval

## 16 Shoot the time-lapse movie.

- Press the <INFO> button and check again the “Time required” and “Interval” displayed on the screen.
- Press the shutter button halfway to check the focus and exposure.
- **Press the shutter button completely to start shooting the time-lapse movie.**
- AF will not work during time-lapse movie shooting.
- During time-lapse movie shooting, <INFO> will blink on the LCD panel. Also, <INFO> will appear on the left of “●”.
- Since the electronic shutter is used for shooting, the reflex mirror and shutter make no mechanical sound during time-lapse movie shooting.
- ▶ When the set number of shots are taken, the time-lapse movie shooting ends.
- ▶ The time-lapse movie shooting is canceled automatically.

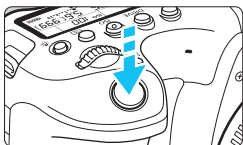

Shots remaining



Time-lapse movie





- Using a tripod is recommended.
- Taking test shots for still photos as in step 14 and shooting test movies for time-lapse movies beforehand is recommended.
- Regardless of the [**1: Movie rec. size**] setting, 4K time-lapse movies are recorded in **4K 29.97P [MPEG] (NTSC)**/**4K 25.00P [MPEG] (PAL)**, while Full HD time-lapse movies are recorded in **FHD 29.97P [ALL-I] (NTSC)**/**FHD 25.00P [ALL-I] (PAL)**.
- The movie's field of view coverage for shooting 4K and Full HD movies is approx. 100%.
- To cancel the time-lapse movie shooting in progress, either press the shutter button completely or press the **<START/STOP>** button (**[Disable]** will be set). The time-lapse movie shot so far will be recorded on the card.
- If the time required for shooting is more than 24 hours but not more than 48 hours, "2 days" will be indicated. If three or more days are required, the number of days will be indicated in 24-hour increments.
- Even if the time-lapse movie's playback time is less than 1 sec., a movie file will still be created. For **[Playback time]**, "00:00:00" will be displayed.
- If the shooting time is long, using the household power outlet accessories (sold separately, p.520) is recommended.
- In the **<A+>** and **<CA>** modes, the scene icon for the scene detected by the camera is displayed on the upper left of the screen (p.329).
- The color sampling recorded will be YCbCr 4:2:2 (8-bit) for 4K time-lapse movies, and YCbCr 4:2:0 (8-bit) for Full HD time-lapse movies. The color matrix recorded will be Rec. ITU-R BT.601 for 4K time-lapse movies, and Rec. ITU-R BT.709 for Full HD time-lapse movies.



- If the card does not have enough free space to record the set number of shots, **[Playback time]** (p.353) will be displayed in red. Although the camera can continue shooting, the shooting will stop when the card becomes full.
- If the card has no available capacity, "Number of shots" (p.355) will be displayed in red as "**0000**", and you will not be able to shoot.
- If the movie file size exceeds 4 GB with the **[No. of shots]** settings and the card is not formatted in exFAT (p.71), **[Play time]** will be displayed in red (p.353). If you keep shooting in this condition and the movie file size reaches 4 GB, the time-lapse movie shooting will stop.





- Do not point the camera toward an intense light source, such as the sun or an intense artificial light source. Doing so may damage the image sensor or the camera's internal components.
- If the camera is connected to a computer with the interface cable (sold separately), or if an HDMI cable is connected to the camera, you cannot select **[Enable]**.
- Movie Servo AF will not function.
- If the shutter speed is 1/30 sec. or slower, the exposure of the movie may not be displayed properly (may differ from that of the resulting movie).
- Do not zoom the lens during time-lapse movie shooting. Zooming the lens may cause the image to be out of focus, the exposure to change, or the lens aberration correction not to function properly.
- When shooting a time-lapse movie under a flickering light, noticeable image flickering, horizontal stripes (noise), or irregular exposures may be recorded.
- The image displayed during time-lapse movie shooting and the resulting movie may look different (in terms of flicker, depth of field, etc.).
- When shooting a time-lapse movie under low light, the image displayed during shooting may look different from what is actually recorded in the movie. In such cases, the <Exp.SIM> icon will blink.
- If you move the camera from left to right (panning) or shoot a moving subject during time-lapse movie shooting, the image may look extremely distorted.
- During time-lapse movie shooting, auto power off will not take effect. Also, you cannot adjust the shooting function and menu function settings, play back images, etc.
- Sound is not recorded for time-lapse movies.
- With time-lapse movie shooting, you can press the shutter button completely to start or stop the movie shooting regardless of the [ **btn function**] setting.
- With [**Interval**] set to less than 3 sec. and [**Auto exposure**] set to [**Each frame**], if the brightness differs greatly from the preceding shot, the camera may not shoot at the set interval.

- If a shutter speed longer than the shooting interval such as when the long exposure is set, or if a slow shutter speed is set automatically, the camera may not be able to shoot at the set interval. Also, shooting may not be performed when the shutter speed and the shooting interval are nearly the same.
- If the next scheduled shot is not possible, it will be skipped. This may shorten the recording time of the created time-lapse movie.
- Even if [LCD auto off] is set to [Disable], the LCD monitor will turn off during the exposure. Also, if the shooting interval is 1 sec., no image will be displayed.
- Even if [LCD auto off] is set to [Disable], the image may not be displayed for the short interval before the next shot.
- If the time it takes to record to the card exceeds the shooting interval due to the shooting functions set or card performance, some of the shots may not be taken with the set intervals.
- The captured images are not recorded as still photos. Even if you cancel the time-lapse movie shooting after only one shot is taken, it will be recorded as a movie file.
- If you connect the camera to a computer with the interface cable (sold separately) and use EOS Utility (EOS software), set [📷5: Time-lapse movie] to [Disable]. If it is set to [Enable], the camera cannot communicate with the computer.
- During time-lapse movie shooting, the lens's Image Stabilizer will not operate.
- If the power switch is set to <OFF>, the Live View shooting/Movie shooting switch is operated, etc. time-lapse movie shooting will be terminated and the setting will be switched to [Disable].
- Even if a flash is used, it will not fire.
- Shooting-ready state of the time-lapse movie is canceled and the setting is switched to [Disable] with the following operations:
  - Selecting either [Clean manually] or [Clean now ] under [🔍4: Sensor cleaning] or selecting [🔍5: Clear all camera settings].
  - Selecting the <SCN>, <📷1>, or <📷2> shooting mode.





- When time-lapse movie shooting ends, the settings are cleared automatically, and the camera returns to normal movie shooting. Note that if you set a slow shutter speed for time-lapse movie shooting and the settings are automatically cleared, the shutter speed may be automatically changed to a speed within the settable range for normal movie shooting.
- If you start time-lapse movie shooting while the white <img alt="Temperature warning icon" data-bbox="245 238 265 258"/> temperature warning (p.334) is displayed, the image quality of the time-lapse movie may deteriorate. It is recommended that you start time-lapse movie shooting after the white <img alt="Temperature warning icon" data-bbox="245 303 265 323"/> disappears (camera's internal temperature decreases).
- If you play back a 4K time-lapse movie with the camera or select [**Slow motion**] and set it to the fastest speed (by turning <img alt="Speed dial icon" data-bbox="245 368 265 388"/> all the way to the right) (p.420), every other frame will be skipped for playback.
- You cannot extract the frames from 4K time-lapse movie during playback (no 4K frame grab feature).
- When shooting with [**Auto Exposure**] set to [**Each frame**], the following will not be recorded in the time-lapse movie's Exif information.
  - Autoexposure shooting: Shutter speed, Aperture



You can shoot time-lapse movies with a fully-charged Battery Pack LP-E6N for roughly as long as shown in the table below (approx. time from start of shooting until the battery becomes exhausted). The possible movie shooting time varies depending on the shooting conditions.

**Total Possible Time for Time-lapse Movie Shooting** (Approx.)

Time-lapse Movie Shooting		Room Temperature (23°C / 73°F)	Low Temperatures (0°C / 32°F)
Interval	LCD monitor		
1 sec.	Turned on	5 hr. 10 min.	4 hr. 30 min.
	Turned off		
10 sec.	Turned on	3 hr. 10 min.	2 hr. 50 min.
	Turned off	7 hr. 00 min.	6 hr. 20 min.

 You can use Remote Controller RC-6 (sold separately, p.271) or Wireless Remote Control BR-E1 (sold separately, p.273) to start and stop the time-lapse movie shooting. Set [ **5: Remote control**] to [**Enable**] beforehand.

● **With Remote Controller RC-6**

Camera Status/ Remote Control Setting	<2> (2-sec. delay)	<●> (Immediate release)
Test-shooting screen	To shooting-ready	Shoots still photo
Shooting-ready	To test-shooting screen	Starts shooting
During time-lapse movie shooting	Ends shooting	Ends shooting

● **With Wireless Remote Control BR-E1**

- First pair the Wireless Remote Control BR-E1 with the camera (p.273).
- Take test shots, then when the camera is ready to shoot (as in step 15 on page 355), set the BR-E1's release mode/movie shooting switch to <●> (immediate release) or <2> (release after 2-sec. delay).
- If the remote controller's switch has been set to <📷>, the time-lapse movie shooting cannot start.

Camera Status/ Remote Control Setting	<2> (2-sec. delay) <●> (Immediate release)	<📷> (Movie shooting)
Test-shooting screen	Shoots still photo	To shooting-ready
Shooting-ready	Starts shooting	To test-shooting screen
During time-lapse movie shooting	Ends shooting	Ends shooting

## MENU Shooting Video Snapshots

You can shoot a series of short movie clips lasting approx. 2 sec., 4 sec., or 8 sec. called video snapshots. The video snapshots can be joined together into a single movie called a video snapshot album. You can thereby show short and quick highlights of a trip or event. A video snapshot album can also be played back together with background music (p.368, 426).

### Video Snapshot Album Concept

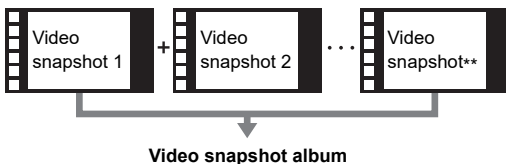

### Setting the Video Snapshot Shooting Duration

1 Set the Mode Dial to a mode other than <SCN>.

2 Select [Video snapshot].

- Under the [5] tab (the [3] tab in Basic Zone modes), select [Video snapshot], then press <SET>.

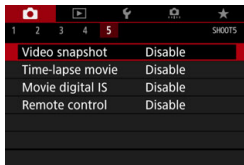

3 Select [Enable].

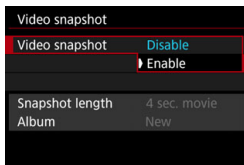

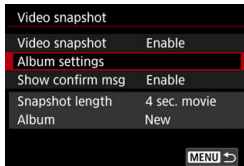

#### 4 Select [Album settings].

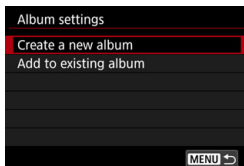

#### 5 Select [Create a new album].

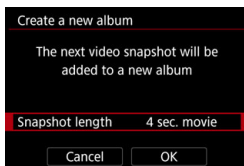

#### 6 Select [Snapshot length].

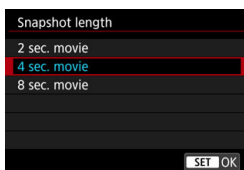

#### 7 Set the snapshot length.

- Select the desired snapshot length, then press <SET>.
- Select [OK].

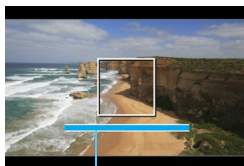

Shooting duration

#### 8 Exit the menu.

- Press the <MENU> button to exit the menu.
- ▶ A blue bar will appear to indicate the snapshot length.
- Go to “Creating a Video Snapshot Album” (p.363).

## Creating a Video Snapshot Album



### 9 Shoot the first video snapshot.

- Press the <START STOP> button, then shoot.
- ▶ The blue bar indicating the shooting duration will gradually decrease. After the set shooting duration elapses, the shooting stops automatically.
- ▶ The confirmation screen will appear (p.364-365).



### 10 Save as a video snapshot album.

- Select [**Save as album**], then press <SET>.
- ▶ The movie clip will be saved as the video snapshot album's first video snapshot.



### 11 Continue to shoot more video snapshots.



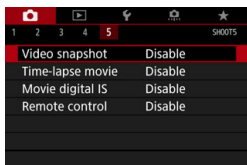



- Repeat step 9 to shoot the next video snapshot.
- Select [**Add to album**], then press <SET>.
- To create another video snapshot album, select [**Save as a new album**].
- Repeat step 11 as necessary.



### 12 Exit the video snapshot shooting.

- Set [**Video snapshot**] to [**Disable**].  
**To return to normal movie shooting, be sure to set [Disable].**
- Press the <MENU> button to exit the menu, and return to the normal movie shooting.

## Options in Steps 10 and 11

Function	Description
 <b>Save as album</b> (Step 10)	The movie clip will be saved as the video snapshot album's first video snapshot.
 <b>Add to album</b> (Step 11)	The video snapshot just recorded will be added to the album recorded immediately before.
 <b>Save as a new album</b> (Step 11)	A new video snapshot album is created and the movie clip is saved as the first video snapshot. The new album will be a different file from the previously recorded album.
 <b>Playback video snapshot</b> (Step 10 and 11)	The video snapshot just recorded will be played back. For playback operations, see the table on the next page.
 <b>Do not save to album</b> (Step 10)  <b>Delete without saving to album</b> (Step 11)	The video snapshot just recorded will be erased instead of being saved to the album. Select <b>[OK]</b> on the confirmation dialog.

 If you want to shoot another video snapshot right after shooting a video snapshot, set **[Disable]** for **[Show confirm msg]** under **[CAMERA 5: Video snapshot]**. This setting will allow you to immediately shoot the next video snapshot without the confirmation screen appearing after you shoot each time.



[ Playback video snapshot] Operations in Steps 10 and 11

Function	Playback Description
Play	By pressing <SET>, you can play back or pause the video snapshot recorded immediately before.
First frame	Displays the first scene of the album's first video snapshot.
Skip backward*	Each time you press <SET>, the video snapshot skips back by a few seconds.
Previous frame	Displays the previous frame each time you press <SET>. Holding <SET> down will rewind the movie.
Next frame	Plays the movie frame-by-frame each time you press <SET>. Holding <SET> down will fast forward the movie.
Skip forward*	Each time you press <SET>, the video snapshot skips forward by a few seconds.
Last frame	Displays the last scene of the album's last video snapshot.
	Playback position
mm' ss"	Playback time (minutes:seconds)
Volume	Turn the <volume dial icon> dial to adjust the volume of the built-in speaker (p.419).
MENU ↶	Pressing the <MENU> button returns to the previous screen.

\* With [Skip backward] and [Skip forward], the skipping length corresponds to the number of seconds set under [Video snapshot] (approx. 2 sec., 4 sec., or 8 sec.).

## Adding to an Existing Album

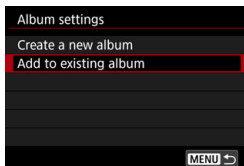

### 1 Select [Add to existing album].

- Follow step 5 on page 362 to select [Add to existing album], then press <SET>.



### 2 Select an existing album.

- Turn the <DISP> dial to select an existing album, then press <SET>.
- Select [OK], then press <SET>.
- ▶ Certain video snapshot settings will change to match the existing album's settings.

### 3 Exit the menu.

- Press the <MENU> button to exit the menu.
- ▶ The video snapshot shooting screen will appear.

### 4 Shoot the video snapshot.

- See "Creating a Video Snapshot Album" (p.363) to shoot the video snapshot.

 You cannot select an album shot with another camera.



## Cautions for Shooting Video Snapshots

- You can add to an album only the video snapshots with the same duration (approx. 2 sec., 4 sec., or 8 sec. each).
- Note that if you do any of the following while shooting video snapshots, a new album will be created for subsequent video snapshots.
  - Changing the [**📷1: Movie rec. size**] setting.
  - Changing the [**Sound rec.**] setting from [**Auto**] or [**Manual**] to [**Disable**] or from [**Disable**] to [**Auto**] or [**Manual**].
  - Updating the firmware.
- The shooting duration of a video snapshot is only approximate. Depending on the frame rate, the shooting duration displayed during playback may not be exact.

## Playing Back an Album

You can play back a video snapshot album in the same way as a normal movie (p.419).



### 1 Play back the movie.

- Press the <▶> button to display an image.

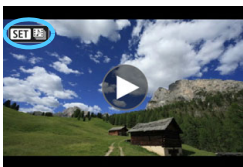

### 2 Select the album.

- In the single-image display, the [SET] [video snapshot icon] icon displayed on the upper left of the screen indicates a video snapshot album.
- Turn the <◉> dial to select an album.



### 3 Play back the album.

- Press <SET>.
- On the movie playback panel displayed, select [▶] (Play), then press <SET>.



## Background Music

- You can play background music when you play back albums, normal movies, and slide shows on the camera (p.420, 426). To play background music, you must first copy the background music to the card using EOS Utility (EOS software). For information on how to copy the background music, refer to the EOS Utility Instruction Manual (p.596).
- Music recorded on the memory card must be used only for private enjoyment. Do not violate the rights of the copyright holder.

## Editing an Album

After shooting, you can rearrange, delete, or play back the video snapshots in the album.



### 1 Select [X].

- On the movie playback panel displayed, select [X] (Edit), then press <SET>.
- ▶ The editing screen will be displayed.



### 2 Select an editing operation.

- Select an editing option, then press <SET>.

Function	Description
↔ Move snapshot	Press the <◀> <▶> keys to select the video snapshot you want to move, then press <SET>. Press the <◀> <▶> keys to move the snapshot, then press <SET>.
🗑 Delete snapshot	Press the <◀> <▶> keys to select the video snapshot you want to delete, then press <SET>. The [🗑] icon will be displayed on the selected video snapshot. Pressing <SET> again will cancel the selection and [🗑] will disappear.
▶ Play snapshot	Press the <◀> <▶> keys to select the video snapshot you want to play back, then press <SET>.



### 3 Save the edited album.

- Press the <MENU> button to return to the Editing panel at the screen bottom.
- Select [] (Save), then press <(SET)>.
- ▶ The save screen will appear.
- To save it as a new album, select [**New file**]. To save it and overwrite the original album, select [**Overwrite**], then press <(SET)>.

- If the card does not have enough free space, [**New file**] will not be available.
- When the battery level is low, editing albums is not possible. Use a fully-charged battery.

## MENU Menu Function Settings

### 1

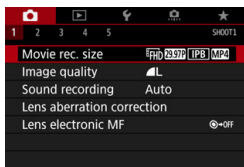

When the Live View shooting/Movie shooting switch is set to <[1]>, some menu options under the [1] tab will be switched to movie shooting items.

- **Movie recording size**

You can set the movie recording quality (image size, frame rate, and compression method). For details, see pages 341-342.

- **Sound recording**

You can set sound recording functions. For details, see page 346.



For more information about the items under the [1] tab, see the following pages: [Image quality] on page 162, [Lens aberration correction] on page 200, and [Lens electronic MF] on page 155.

### 2

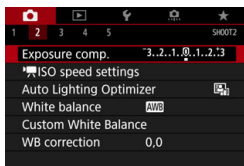

When the Live View shooting/Movie shooting switch is set to <[2]>, the menu options for the ISO speed settings will be switched to [2: ISO speed settings]. (In Basic Zone modes, [ISO speed settings] will not be displayed.)



For more information about the items under the [2] tab, see the following pages: [Exposure compensation] on page 245, [Auto Lighting Optimizer] on page 194, [White balance] on page 185, [Custom White Balance] on page 188, and [WB Shift/Bkt.] on page 191.

- **ISO speed settings** ☆

- **ISO speed**

In the **<M>** mode, you can set the ISO speed manually. You can also select ISO Auto. You can also use the **<ISO>** button for these settings.

- **ISO speed range**

For movie shooting, you can set the manual ISO speed setting range (minimum and maximum limits). By default, it is set to ISO 100 - ISO 25600. You can set the minimum limit within ISO 100 to H1 (equivalent to ISO 51200), and the maximum limit within ISO 200 to H2 (equivalent to ISO 102400).

- **ISO Auto**

In the **<P>**, **<Tv>**, **<Av>**, and **<B>** modes or with the **<M>** mode + ISO Auto setting, you can set the maximum limit for the ISO speed to be set automatically for movie shooting. By default, it is set to is **[Max.:25600]**. You can set the maximum limit within **[Max.:6400]** to **[Max.:H2 (102400)]**.

- **ISO Auto**

In the **<P>**, **<Tv>**, **<Av>**, and **<B>** modes or with the **<M>** mode + ISO Auto setting, you can set the maximum limit for the ISO speed to be set automatically for time-lapse movie shooting. The default setting is **[Max.:12800]**. You can set the maximum limit within **[Max.:400]** to **[Max.:25600]**.



- For movie shooting, ISO 32000 and ISO 40000 are the expanded ISO speeds. When you set them, **[H]** will be displayed.
- Regarding **[CAMERA 2: ISO speed settings]** for still photo shooting (viewfinder or Live View shooting), see pages 170-174.



## 📷4

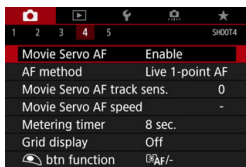

When the Live View shooting/Movie shooting switch is set to <📷>, the [📷4] tab will be displayed as the menu options exclusive to movie shooting. (In Basic Zone modes, it will be the [📷2] tab.)

### ● Movie Servo AF

With this function enabled, the camera focuses on the subject continuously during movie shooting. The default setting is **[Enable]**.

#### When **[Enable]** is set:

- The camera focuses on the subject continuously even when you are not pressing the shutter button halfway.
- If you want to keep the focus at a specific point or if you do not want the lens mechanical sound to be recorded, you can temporarily stop Movie Servo AF as follows.
  - Tap [] on the screen's bottom left.
  - If you assign **[Pause Movie Servo AF]** (p.500) to <ⓈET>, under [ **C.Fn III-4: Custom controls**], you can press <ⓈET> to pause the Movie Servo AF. When you press <ⓈET> again, Movie Servo AF will resume.
  - If you assign a button to **[AF stop]** (p.500), you can pause the Movie Servo AF while holding that button down. When you let go of the button, Movie Servo AF will resume.
- When Movie Servo AF is paused, if you return to movie shooting after operations such as pressing the <MENU> or <▶> button or changing the AF method, Movie Servo AF will resume.

**When [Disable] is set:**

- Press the shutter button halfway or press the <AF-ON> button to focus.

**Cautions When [Movie Servo AF] is Set to [Enable]**

- **Shooting Conditions that Make Focusing Difficult**
  - A fast-moving subject approaching or moving away from the camera.
  - A subject moving at a close distance to the camera.
  - When shooting with a higher f/number.
  - Also see “Shooting Conditions that Make Focusing Difficult” on page 316.
- Since the lens is driven continuously and battery power consumed, the possible movie shooting time (p.344) will be shortened.
- With certain lenses, the mechanical sound for focusing may be recorded. In such a case, using Directional Stereo Microphone DM-E1 (sold separately) may reduce such sounds in the movie.
- Movie Servo AF will pause during zooming or magnified view.
- During movie shooting, if a subject approaches or moves away or if the camera is moved vertically or horizontally (panning), the recorded movie image may momentarily expand or contract (change in image magnification).
- If you want to set the lens's focus mode switch to <MF> during Movie Servo AF, first set the Live View shooting/Movie shooting switch to <📷>.

● **AF method**

You can select [+Tracking], [Smooth zone], or [Live 1-point AF]. See pages 308-314 for the AF method.

## ● Movie Servo AF tracking sensitivity<sup>\*</sup>

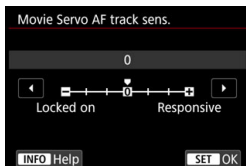

You can change the Movie Servo AF's tracking sensitivity to one of seven levels. This affects the responsiveness of AF tracking sensitivity when the subject strays from the AF points, such as during panning or when an obstacle cuts across the AF points.

This function is settable when [**4**]: **Movie Servo AF** is set to [**Enable**] and [**4**]: **AF method** is set to [**Live 1-point AF**].

### Locked on: -3/-2/-1

This setting makes the camera less inclined to track a different subject if the AF point loses the original subject. The closer the setting is to the minus (-) symbol, the less the camera is inclined to track a different subject. It is effective when you want to prevent the AF points from rapidly tracking something that is not the intended subject during panning or when an obstacle cuts across the AF points.

### Responsive: +1/+2/+3

This makes the camera more responsive when tracking a subject that covers the AF point. The closer the setting is to the plus (+) symbol, the more responsive the camera is. It is effective when you want to keep tracking a moving subject as its distance from the camera changes or to rapidly focus on another subject.

 Setting [**4**]: **AF method** to [**L** + tracking] or [**Smooth zone**] results in the same effect as when [0] is set.

## ● Movie Servo AF Speed\*

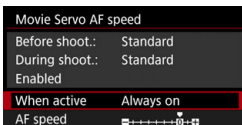

You can set the Movie Servo AF's AF speed and its operation conditions.

This function is settable when [**4: Movie Servo AF**] is set to [**Enable**] and [**4: AF method**] is set to [**Live 1-point AF**].

Additionally, the function is enabled when using a lens supporting slow focus transition during movie shooting\*.

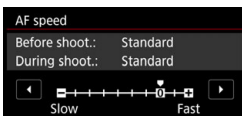

### When active:

You can set [**Always on**] to have the AF speed take effect at all times for movie shooting (before and during movie shooting) or set [**During shooting**] to have the AF speed take effect only during movie shooting.

### AF speed:

You can adjust the AF speed (focus transition speed) from the standard speed (0) to slow (one of seven levels) or fast (one of two levels) to obtain the desired effect for the movie creation.

### \* Lenses supporting slow focus transition during movie shooting

USM and STM lenses released in and after 2009 are compatible. For details, refer to the Canon Web site.

 With certain lenses, even if the AF speed is adjusted, the speed may not change.

- Setting [**4: AF method**] to [**Tracking**] or [**Smooth zone**] results in the same effect as setting [**AF speed**] to [**Standard (0)**].
- If the [**4: Movie Servo AF Speed**] setting is changed from the default, an asterisk "\*" will be displayed on the right end of [**4: Movie Servo AF Speed**].

- **Metering timer**<sup>☆</sup>

You can change how long the exposure setting is displayed (AE lock time).

- **Grid display**







With [3x3 卐] or [6x4 卐卐], you can display grid lines to help you level the camera vertically or horizontally. Also, with [3x3+diag 卐], the grid is displayed together with diagonal lines to help you compose with better balance by aligning the intersections over the subject.



Note that the grid is not displayed on the LCD monitor during movie shooting.







## ● button function



You can set the functions performed by pressing the shutter button halfway or completely during movie shooting.

Setting	Pressing halfway	Pressing completely
 AF/-	Metering and AF	No function
 /-	Metering only	No function
 AF/ 	Metering and AF	Starts/stops movie shooting
 	Metering only	Starts/stops movie shooting

If [ AF/

- Even if [ 4:  btn function] is set to [ AF/-] or [ /-], pressing the shutter button completely during time-lapse movie shooting will start or stop the time-lapse movie shooting.
- During movie shooting, the [ 4:  btn function] setting overrides any function assigned to the shutter button with [ .C.Fn III-4: Custom Controls].

## 📷 5

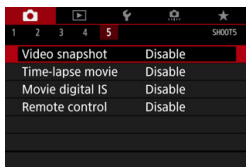

When the Live View shooting/Movie shooting switch is set to <📷>, the [📷 5] tab will be displayed as the menu options exclusive to movie shooting. (In Basic Zone modes, it will be the [📷 3] tab.)

- **Video snapshot**

You can shoot video snapshots. For details, see page 361.

- **Time-lapse movie**

You can shoot time-lapse movies. For details, see page 349.

## ● Movie digital IS

In-camera image stabilization electronically corrects camera shake during movie shooting. This function is called “Movie digital IS”. With Movie digital IS, images can be stabilized even when using a lens without Image Stabilizer. When using a lens with built-in optical Image Stabilizer, Movie digital IS will function when the lens’s Image Stabilizer switch is set to <ON>.

**Disable** (  ) : Image stabilization with Movie digital IS is disabled.

**Enable** (  ) : Camera shake will be corrected. The image will be slightly magnified.

**Enhanced**(  ) : Compared to when [Enable] is set, stronger camera shake can be corrected. The image will be more magnified.



- Movie digital IS will not function when the lens’s optical Imager Stabilizer switch is set to <OFF> (  ).
- With a lens whose focal length is longer than 800 mm, Movie digital IS will not function.
- Movie digital IS cannot be set during HDR movie shooting (with SCN mode set) or time-lapse movie shooting.
- The wider the angle of view (wide angle), the more effective the image stabilization will be. The narrower the angle of view (telephoto), the less effective the image stabilization will be.
- When using a tripod, setting Movie digital IS to [Disable] is recommended.
- Depending on the subject and shooting conditions, the subject may blur noticeably (the subject momentarily looks out of focus) due to the effects of the Movie digital IS.
- When using a TS-E lens, fish-eye lens, or non-Canon lens, setting Movie digital IS to [Disable] is recommended.
- The effect of Movie digital IS will not be reflected in any magnified image.
- Since Movie digital IS magnifies the image, the image looks more grainy. Noise, dots of light, etc. may also become noticeable.
- When Movie digital IS is set, the size of AF points will also change.
- Certain lenses do not support Movie digital IS. For details, refer to the Canon Web site.



- **Remote control shooting**

When [**Enable**] is set, you can start or stop movie shooting using Remote Controller RC-6 (sold separately, p.271) or Wireless Remote Control BR-E1 (sold separately, p.273).

- **When using Remote Controller RC-6**

Set the switch to the <2> position, then press the transmit button. If the switch is set to <●> (immediate release), the [4:  btn function] setting will take effect.

- **With Wireless Remote Control BR-E1**

Set the release mode/movie shooting switch to the <'■> position, then press the release button.

For Time-lapse movie shooting, see page 360.

## General Movie Shooting Cautions

### Red <img alt="Red temperature warning icon" data-bbox="165 142 195 162"/> Internal Temperature Warning Icon

- If the camera's internal temperature increases due to prolonged movie shooting or under a high ambient temperature, a red <img alt="Red temperature warning icon" data-bbox="165 185 195 205"/> icon will appear.
- The red <img alt="Red temperature warning icon" data-bbox="165 225 195 245"/> icon indicates that movie shooting will soon be terminated automatically. If this happens, you will not be able to shoot again until the camera's internal temperature decreases. Turn off the power and let the camera rest for a while.
- Shooting a movie at a high temperature for a prolonged period will cause the red <img alt="Red temperature warning icon" data-bbox="165 335 195 355"/> icon to appear earlier. When you are not shooting, always turn off the camera.

### Recording and Image Quality

- If the attached lens has an Image Stabilizer and you set the Image Stabilizer (IS) switch to <ON>, the Image Stabilizer will operate at all times even if you do not press the shutter button halfway. The Image Stabilizer consumes battery power and may shorten the total movie shooting time depending on the shooting conditions. When the Image Stabilizer is not necessary, such as when using a tripod, it is recommended that you set the IS switch to <OFF>.
- If the brightness changes during autoexposure movie shooting, the movie image may freeze temporarily. In such a case, shoot movies with manual exposure.
- If there is a very bright light source in the image, the bright area may appear black on the LCD monitor. The movie will be recorded almost exactly as it appears on the LCD monitor.
- In low light, noise or irregular colors may appear in the image. The movie will be recorded almost exactly as it appears on the LCD monitor.
- If you play back a movie with other devices, image or sound quality may deteriorate or playback may not be possible (even if the devices support MP4/MOV format).

## General Movie Shooting Cautions

### Recording and Image Quality

- If you use a card with a slow writing speed, a five-level indicator may appear on the right of the screen during movie shooting. It indicates how much data has not yet been written to the card (remaining capacity of the internal buffer memory). The slower the card, the faster the indicator will climb upward. If the indicator becomes full, movie shooting will stop automatically.

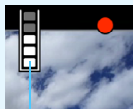

Indicator

If the card has a fast writing speed, the indicator will either not appear or the level (if displayed) will hardly go upward. First, shoot a few test movies to see if the card can write fast enough.

- If the indicator indicates that the card is full and movie shooting stops automatically, the sound near the end of the movie may not be recorded properly.
- If the card's writing speed is slow (due to fragmentation) and the indicator appears, formatting the card may make the writing speed faster.

### Playback and TV Connection

- If you connect the camera to a TV set (p.427) and shoot a movie, the TV set will not output any sound during the shooting. However, the sound will be properly recorded.

## Restrictions on MP4-format Movies

Note that generally, the following restrictions apply to MP4-format movies.

- Sound will not be recorded for approx. the last two frames.
- When you play back movies on Windows, movie images and sound may become slightly out of synchronization.



---

---

---

---

---

---

---

---

---

---

---

---

---

---

---

---

---

---

---

---

---

---

---

---

---

---

---

---

---

---



# 10

## Image Playback

This chapter describes how to play back and erase the captured images (still photos/movies), how to view them on a TV screen, and other playback-related functions.

### **Images shot and saved with another device**

The camera may not be able to properly display images captured with a different camera, edited with a computer, or that have had their file names changed.

# ▶ Image Playback

## Single-Image Display



### 1 Play back the image.

- Press the <▶> button.
- ▶ The last image captured or played back will appear.

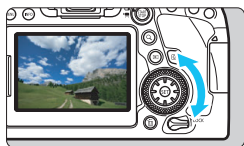

### 2 Select an image.

- To play back images starting with the last image captured, turn the <◀> dial counterclockwise.
- To play back images starting with the first captured image, turn the dial clockwise.
- Each time you press the <INFO> button, the display will change.

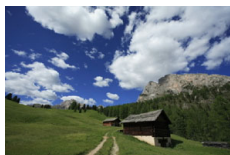

No information



Basic information display



Shooting information display



### 3 Exit the image playback.

- Press the <▶> button to exit the image playback and return to shooting-ready state.



- When RAW images shot with [📷4: Aspect ratio] set to an option other than [3:2] (p.168) are played back, frame lines indicating the image area will be displayed.
- If the search conditions are set with [▶2: Set image search conditions] (p.402), only the found images will be displayed.

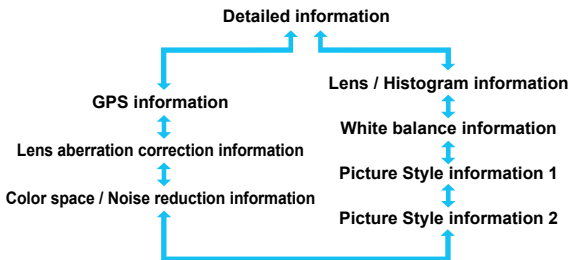

## Shooting Information Display

With the shooting information screen displayed (p.388), you can press the <▲> <▼> keys to change the shooting information displayed at the screen bottom as follows. For details, see pages 392-395.

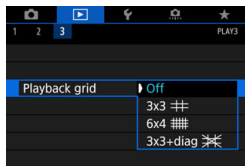

## MENU Grid Display



In the single-image display, you can overlay the grid on the image playback. With [**▶3: Playback grid**], you can select [**3x3** ], [**6x4** ], or [**3x3+diag** ].

This function is convenient for checking the image's vertical or horizontal tilt as well as composition.

 The grid is not displayed during movie playback.

# INFO: Shooting Information Display

## Sample Information for Still Photos

### ● Basic information display

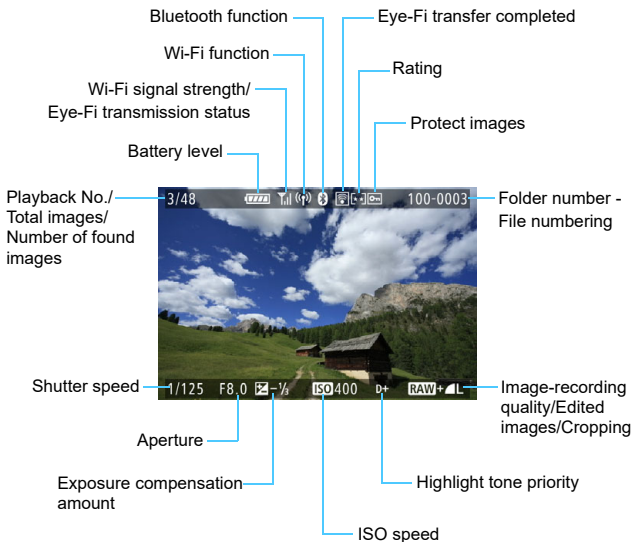

- If the image was taken by another camera, certain shooting information may not be displayed.
- It may not be possible to play back images taken with this camera on other cameras.

## ● Shooting information display

### ● Detailed Information for Creative Zone Mode Images

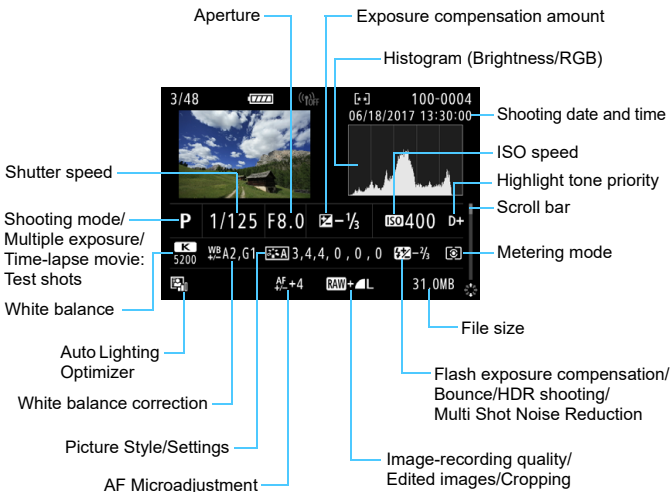

- \* When you shoot in RAW+JPEG image quality, the RAW image file size will be displayed.
- \* Lines indicating the image area will be displayed for images taken with the aspect ratio set (p.168) and with RAW or RAW+JPEG set for image quality.
- \* During flash photography without flash exposure compensation, <f> will be displayed.
- \* <f> will be displayed for images shot with bounce flash photography.
- \* An icon for the effect (p.254) and the dynamic range adjustment amount will be displayed for images shot with HDR shooting.
- \* <M> will be displayed for images shot with multiple-exposure shooting.
- \* <NR> will be displayed for images shot with Multi Shot Noise Reduction.
- \* <T> will be displayed for still photos taken as test shots for time-lapse movies.
- \* <C> will be displayed for images created and saved after performing RAW image processing, resizing, or cropping.
- \* <C> will be displayed for images cropped and then saved.

- Detailed Information for Basic Zone Mode Images

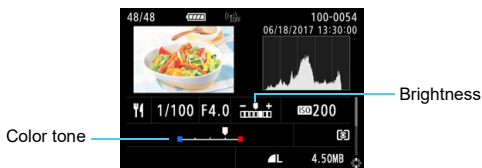
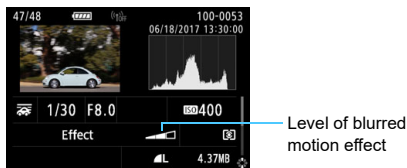
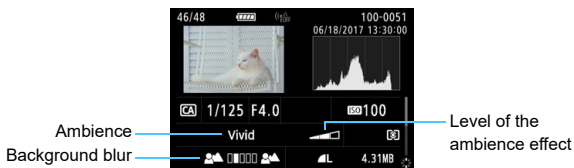

\* **[Brightness]** indicator is displayed for images whose brightness was adjusted for shooting.

• Lens / Histogram information

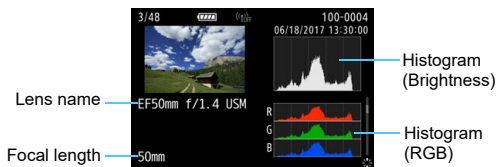

• White balance information

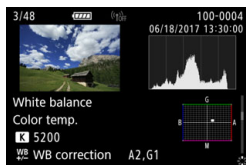

• Picture Style information 1

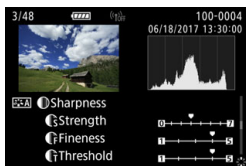

• Picture Style information 2

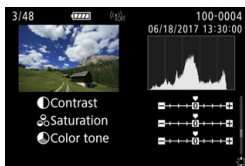

- **Color space / Noise reduction information**

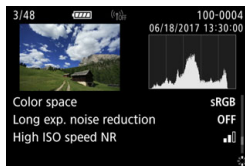

- **Lens aberration correction information**

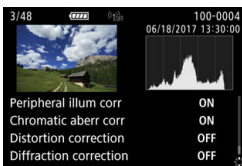

- **GPS information**

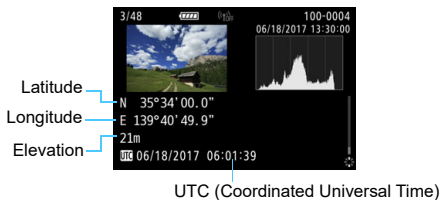

- The GPS information screen is not displayed when GPS information is not recorded to the images.
- Even if you use the camera to play back an image taken by another camera (with GPS information recorded), the GPS information will not be displayed.

## Sample Movie Information Display

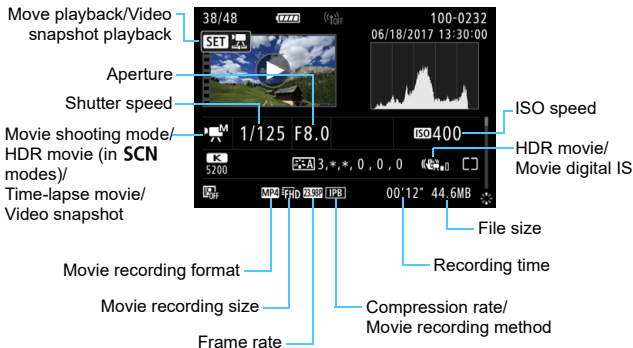

- <A\*/H\*/M>: Shutter speed, aperture, and ISO speed are not displayed.
- <M> + ISO Auto: ISO speed is not displayed.
- <M>, <M> or <A> will be displayed for time-lapse movies. Note that the "Shutter speed", "Aperture", or "ISO speed" will not be displayed for time-lapse movies when "Autoexposure shooting" is performed with **[Each frame]** set for **[Auto exposure]** under **[5: Time-lapse movie]**. "ISO speed" will not be displayed for time-lapse movies shot with "Manual exposure shooting".
- <M> will be displayed for video snapshots.
- <M> or <M> will be displayed for movies with camera shake corrected by Movie digital IS.

During movie playback, "A", "M" will be displayed for **[Fineness]** and **[Threshold]** of **[Picture Style]**'s **[Sharpness]**.



- **Highlight alert**

When [] **3: Highlight alert**] is set to [**Enable**], overexposed, clipped highlights will blink. To obtain more detailed gradation in the blinking areas where you want the gradation to be faithfully reproduced, set the exposure compensation to a negative amount and shoot again for a better result.

- **AF point display**

When [] **3: AF point disp.**] is set to [**Enable**], the AF point that achieved focus will be displayed in red. If automatic AF point selection is set, multiple AF points may be displayed.

## ● Histogram

The brightness histogram shows the exposure level distribution and overall brightness. The RGB histogram is for checking the color saturation and gradation. The display can be switched with [▶] 3: **Histogram disp.**

## ● [Brightness] display

This histogram is a graph showing the distribution of the image's brightness level. The horizontal axis indicates the brightness level (darker on the left and brighter on the right) while the vertical axis indicates how many pixels exist for each brightness level. The more pixels there are toward the left, the darker the image. The more pixels there are toward the right, the brighter the image. If there are too many pixels on the left, the shadow detail will be lost. If there are too many pixels on the right, the highlight detail will be lost. The gradation in-between will be reproduced. By checking the image and its brightness histogram, you can see the exposure level inclination and the overall gradation.

### Sample Histograms



Dark image



Normal brightness



Bright image

## ● [RGB] display

This histogram is a graph showing the distribution of each primary color's brightness level in the image (RGB or red, green, and blue). The horizontal axis indicates the color's brightness level (darker on the left and brighter on the right), while the vertical axis indicates how many pixels exist for each color brightness level. The more pixels there are toward the left, the darker and less prominent the color. The more pixels there are toward the right, the brighter and denser the color. If there are too many pixels on the left, the respective color information will be lacking. If there are too many pixels on the right, the color will be too saturated with no gradation. By checking the image's RGB histogram, you can see the color's saturation and gradation condition, as well as white balance inclination.

## Index display (Multiple-image Display)

Search for images quickly with the index display showing 4, 9, 36, or 100 images on one screen.





### 1 Press the <Q> button.

- During image playback or when the camera is ready to shoot, press the <Q> button.
- ▶ [  Q ] will be displayed on the lower right of the screen.







### 2 Switch to the index display.



- Turn the <  > dial counterclockwise.
- ▶ The 4-image index display will appear. The selected image is highlighted with an orange frame.

- Turning the <  > dial further counterclockwise will switch the display from 9 images, 36 images, and to 100 images. If you turn the dial clockwise, it will rotate through 100, 36, 9, 4, and single-image display.



### 3 Select an image.

- Operate the <  > dial or <  > to move the orange frame and select the image.
  - Press the <Q> button to turn off the [  Q ] icon, then turn the <  > dial to display the image(s) on the next or previous screen.
- Press <  > in the index display to display the selected image in the single-image display.



 If the search conditions are set with [  2: Set image search conditions ] (p.402), only the found images will be displayed.

## Jump Display (Jumping Through Images) ■

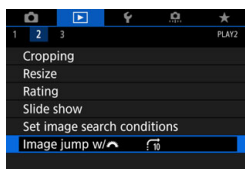
In the single-image display, you can turn the  dial to jump through the images forward or backward according to the jump method set.



### 1 Select [Image jump w/ ].

- Under the [ 2] tab, select [Image jump w/ , then press  >.

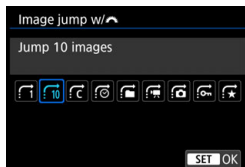

### 2 Select the jump method.

- Select the jump method, then press  >.

: Display images one by one

: Jump by 10 images

: Jump images by the specified number

: Display by date



: Display by folder

: Display movies only

: Display stills only

: Display protected images only

: Display by image rating  
(p.412)

- With [Jump images by the specified number], you can turn the  dial to select the number of images within 1 to 100 you want to jump by.
- When you select [Display by image rating], turn the  dial to specify the rating. If you browse images with ★ selected, all the rated images will be displayed.

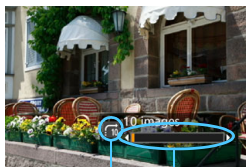

Jump method

Playback position

### 3 Browse by jumping.

- Press the <▶> button to play back images.
- In the single-image display, turn the <⏮> dial.
- ▶ You can browse by the set method.



- To search images by shooting date, select [ : **Date**].
- To search images by folder, select [ : **Folder**].
- If the card contains both movies and still photos, select [ : **Movies**] or [ : **Stills**] to display one or the other.
- If the jump method is set to [ : **Protect**] or [ : **Rating**] but no images are protected or have ratings, you cannot use the <⏮> dial to browse through images.
- If search conditions are set with [ **2: Set image search conditions**] (p.402), only the found images will appear in jump display.

## Filtering Images for Playback



You can play back images filtered according to search conditions. After setting the image search conditions, you can play back and display only the found images.

Note that the following can be done for the found images: Erase protection, rating, slide show, deletion, print order, and photobook order.

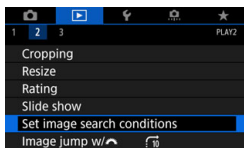
This feature enables you to quickly do a specific task to the found images in one batch.



### 1 Select [Set image search conditions].

- Under the [] 2 tab, select [Set image search conditions], then press <  >.

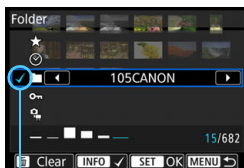

### 2 Set the search conditions.

- Press the <▲> <▼> keys to select an item.
- Press the <◀> <▶> keys to set the setting.
- A checkmark [✓] is appended to the left of the item. (Specified as the search condition.)

Checkmark

- If you select the item and press the <INFO> button, the checkmark [✓] will be removed. (The search condition is canceled.)

Item	Setting
★ Rating	Images with the selected (rating) condition will be displayed.
📅 Date	Images taken on the selected shooting date will be displayed.
📁 Folder	Images in the selected folder will be displayed.
🔒 Protect	Images with the selected (protect) condition will be displayed.
📁 Type of file	Displays images in the selected file type. The following file formats can be set: [📷 Stills], [📷 (RAW)], [📷 (RAW,RAW+JPEG)], [📷 (RAW+JPEG)], [📷 (RAW+JPEG, JPEG)], [📷 (JPEG)], and [🎬 Movies].

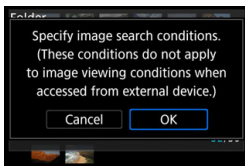

### 3 Implement the search conditions.

- Read the message that appears.
- Select [OK], then press <SET>.
- ▶ The search condition is specified.

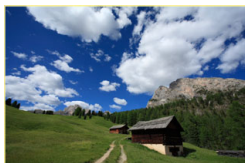

Yellow frame

### 4 Display the found images.

- Press the <▶> button to play back images.
- ▶ Only the images that match the set conditions (filtered) will be played back.
- ▶ When the images are filtered, the screen will have an outer yellow frame.

## Clearing the Search Conditions

Display the screen in step 2, then press the <⌵> button to remove all the checkmarks [✓]. Press the <SET> button, then select [OK] to clear the search conditions.



If there are no images matching the search conditions, pressing <SET> on the screen in step 2 will not enable [OK]. (Cannot proceed to step 3.)



- Even if [⚡2: Auto power off] is set to [1 min.], [2 min.], or [4 min.], the auto power off time will be approx. 6 min. when the [▶2: Set image search conditions] screen is displayed.
- Doing any of the following will clear the search conditions, and the filtered display will end. ([Image search canceled] may also appear on the screen.)
  - Shooting is performed.
  - Auto power off takes effect.
  - Setting the power switch to <OFF>.
  - Formatting the card.
  - Opening the battery compartment cover or card slot cover.
  - Adding an image (processing a RAW image, resizing an image, cropping an image, etc.).
  - When there are no longer any images matching the search conditions.
  - All the camera settings are cleared.

## 🔍 Magnifying Images

You can magnify a captured image by approx. 1.5x to 10x on the LCD monitor.



### 1 Magnify the image.

- The image can be magnified as follows: 1. During image playback, 2. During the image review after image capture, and 3. From the shooting-ready state.
- Press the <Q> button.
- ▶ The magnified view will appear. The magnified area position and [🔍 Q] will be displayed on the lower right of the screen.
- The image magnification increases as you turn the <🔍> dial clockwise. You can magnify the image up to approx. 10x.
- The image magnification decreases as you turn the <🔍> dial counterclockwise. In the case of 1 and 3 only, turning the dial further will display the index display (p.399).



Magnified area position

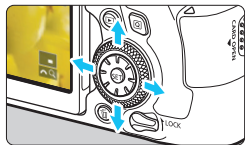

### 2 Scroll around the image.

- Use <🌀> to scroll around the magnified image.
- Press the <Q> button or <▶> button to exit the magnified view.

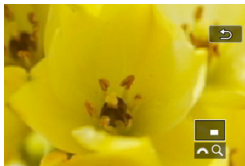

- In the case of 1 and 3 only, you can turn the <🌀> dial to view another image while maintaining the magnified view.
- A movie cannot be magnified.



## MENU Setting the Initial Magnification Ratio and Position

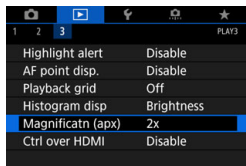

Under the [] 3 tab, when you select [**Magnificatn (apx)**], you can set the initial magnification ratio and position for the magnified view.

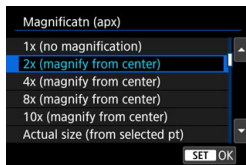

- **1x (no magnification)**

The image is not magnified. The magnified view will start with the single-image display.

- **2x, 4x, 8x, 10x (magnify from center)**

The magnified view starts at the image center at the selected magnification.

- **Actual size (from selected point)**

The recorded image's pixels will be displayed at approx. 100%. The magnified view starts at the AF point that achieved focus. If the photo is taken with manual focus, the magnified view starts at the image center.

- **Same as last magnification (from center)**

The magnification will be the same as the last time you exited the magnified view with the <> or <Q> button. The magnified view starts at the image center.



For images taken with [**Live 1-point AF**] (p.313) or with [**Distortion correction**] set to [**Enable**] (p.202), the magnified view will start at the image center even if [**Actual size (from selected pt)**] has been set.

## Playing Back with the Touch Screen

The LCD monitor is a touch-sensitive panel that you can touch with your fingers for various playback operations. **First, press the <▶> button to play back images.**

### Browsing Images

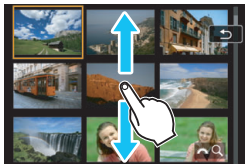

### Swipe with one finger.

- With single-image display, touch the LCD monitor with **one finger**. You can browse to the next or previous image by swiping your finger to the left or right.

Swipe to the left to see the next (newer) image, or swipe to the right to see the previous (older) image.

- With index display, also touch the LCD monitor with **one finger**. You can browse to the next or previous screen by swiping your finger up or down. Swipe up to see the next (newer) images or swipe down to see the previous (older) images.

When you select an image, the orange frame will appear. Tap on the image again to display it as a single image.

### Jumping through Images (Jump Display)



### Swipe with two fingers.

Touch the LCD monitor with **two fingers**. When you swipe two fingers to the left or right, you can jump through images with the method set in [Image jump w/ ] under the [▶]2 tab.

## Reducing Image (Index Display)

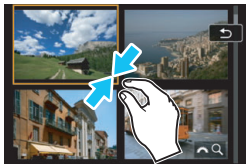

### Pinch two fingers.

Touch the screen with two fingers spread apart, and pinch your fingers together on the screen.

- Each time you pinch your fingers, the image will shrink. If you pinch the single-image display, it will change to the 4-image index display.
- When you select an image, the orange frame will appear. Tap on the image again to display it as a single image.

## Magnifying Image

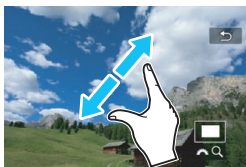

### Spread two fingers apart.

Touch the screen with two fingers together, then spread your fingers apart on the screen.

- As you spread your fingers, the image will be magnified.
- The image can be magnified up to approx. 10x.
- To reduce the image, pinch your fingers together on the screen.
- If you do this on a 4-image index display, it will change into the single-image display.

## Double-tap.

You can magnify the image by using one finger to quickly tap twice (double-tap) on the LCD monitor. The image will be magnified on the spot where you tap. To return to the single-image display, double-tap on the image again.

- To scroll around the position of magnified display in magnified view, touch the LCD monitor with one finger and move it around.





- You cannot magnify the image by double-tapping in the index display.
- Touch operations on the camera's LCD monitor are also possible while playing back images on a TV set connected to your camera (p.427).

## Rotating the Image

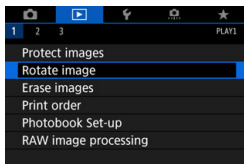
You can rotate the displayed image to the desired orientation.



### 1 Select [Rotate image].

- Under the [] 1 tab, select [Rotate image], then press < >.

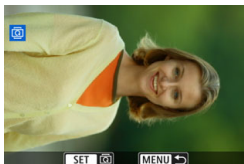





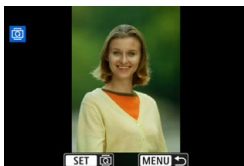



### 2 Select an image.

- Turn the < > dial to select the image to be rotated.
- You can also select an image in the index display (p.399).



### 3 Rotate the image.

- Each time you press < >, the image will rotate clockwise as follows: 90° → 270° → 0°.
- To rotate another image, repeat steps 2 and 3.



- If you set [ 1: Auto rotate] to [On  ] (p.435) before taking vertical shots, you need not rotate the image as described above.
- If the rotated image is not displayed in the rotated orientation during image playback, set [ 1: Auto rotate] to [On  ].
- A movie cannot be rotated.
- If the search conditions are set with [ 2: Set image search conditions] (p.402), only the found images will be displayed.

## Protecting Images

You can protect important images from being accidentally erased by the camera's erase function.

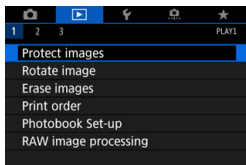
### **MENU** Protecting a Single Image



- 1 Select [Protect images].**
  - Under the [ 1] tab, select [**Protect images**], then press < >.

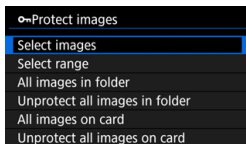







- 2 Select [Select images].**
  - An image will be displayed.

Image protection icon



- 3 Select the image to be protected.**
  - Turn the < > dial to select the image to be protected.

- 4 Protect the image.**
  - Press < > to protect the selected image. The < > icon will appear at the top of the screen.
  - To cancel the image protection, press < > again. The < > icon will disappear.
  - To protect another image, repeat steps 3 and 4.

 If the search conditions are set with [ 2: Set image search conditions] (p.402), only the found images will be displayed.

## MENU Specifying the Range of Images to be Protected

While looking at the images in the index display, you can specify the first and last images for a range to protect all the specified images at once.

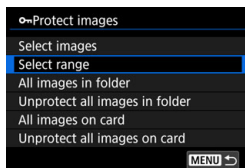

### 1 Select [Select range].

- Under [**▶** 1: Protect images], select [Select range] and press <SET>.

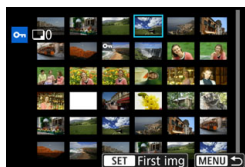

### 2 Specify the range of images.

- Select the first image (start point), then press <SET>.
- Next, select the last image (end point), then press <SET>.
- ▶ The images in the specified range will be protected and the <[▶]> icon will appear.
- To select another image to be protected, repeat step 2.

- If the search conditions are set with [**▶** 2: Set image search conditions] (p.402), only the found images will be displayed.
- If you specify a protected image as the first image in the range, all images in the range (from the first image to the last) will become unprotected instead. (Protection will be canceled in the specified range.)

## MENU Protecting All Images in a Folder or on a Card

You can protect all the images in a folder or on a card at once.

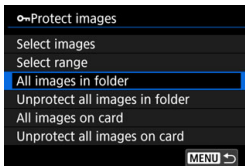

When you select [**All images in folder**] or [**All images on card**] in [▶ 1: **Protect images**], all the images in the folder or on the card will be protected. To cancel the selection, select [**Unprotect all images in folder**] or [**Unprotect all images on card**].

If the search conditions are set with [▶ 2: **Set image search conditions**] (p.402), the display will change to [**All found images**] and [**Unprotect all found**].

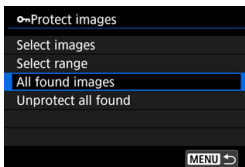

If you select [**All found images**], all the found images will be protected. If you select [**Unprotect all found**], the protection of all the found images will be canceled.

**If you format the card (p.70), the protected images will also be erased.**



- Movies can also be protected.
- Once an image is protected, it cannot be erased by the camera's erase function. To erase a protected image, you must first cancel the protection.
- If you erase all the images (p.433), only the protected images will remain. This is convenient when you want to erase all unnecessary images at once.

## [☆☆] Setting Ratings

You can rate images (still photos and movies) with one of the five rating marks: [★]/[★★]/[★★★]/[★★★★]/[★★★★★]. This function is called rating.

### MENU Rating a Single Image

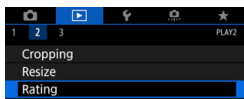

#### 1 Select [Rating].

- Under the [▶]2 tab, select [Rating], then press <SET>.

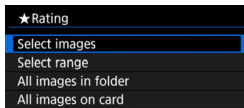

#### 2 Select [Select images].

- An image will be displayed.

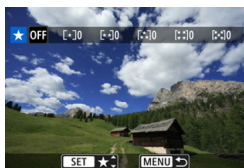

#### 3 Select the image to be rated.

- Turn the <⌚> dial to select the image to be rated.
- If you press the <Q> button and turn the <⌚> dial counterclockwise, you can select an image from a three-image display. To return to the single-image display, turn the dial clockwise.



#### 4 Rate the image.

- Press <SET>, and a blue highlight frame will appear as shown in the screen shown on the left.
- Press the <▲> <▼> keys to select a rating mark, then press <SET>.
- When you append a rating mark for the image, the number beside the set rating will increase by one.
- To rate another image, repeat steps 3 and 4.

If the search conditions are set with [▶]2: Set image search conditions (p.402), only the found images will be displayed.



## MENU Rating by Specifying the Range

While looking at the images in the index display, you can specify the first and last images for a range to rate all the specified images at once.

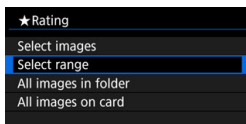

### 1 Select [Select range].

- Select [Select range] in [▶2: Rating], then press <SET>.

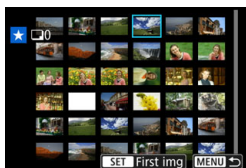

### 2 Specify the range.

- Select the first image (start point), then press <SET>.
- Next, select the last image (end point), then press <SET>.
- ▶ A checkmark [✓] will be appended to all the images within the range between first and last images.

### 3 Press the <Q> button.



### 4 Rate the image.

- Turn the <DIAL> dial to select a rating mark, then select [OK].
- ▶ All the images in the specified range will be rated (same rating) at once.

If the search conditions are set with [▶2: Set image search conditions] (p.402), only the found images will be displayed.

## MENU Rating All Images in a Folder or on a Card

You can rate all the images in a folder or on a card at once.

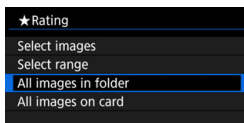

Under [▶2: Rating], when you select [All images in folder] or [All images on card], all the images in the folder or on the card will be rated.



Turn the <☺> dial to select a rating, then select [OK].

When you are not rating images or cancelling the rating, select [OFF].

If the search conditions are set with [▶2: Set image search conditions] (p.402), the display will change to [All found images].

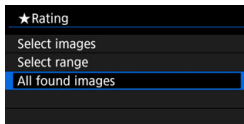













If you select [All found images], all the found images filtered by the search conditions will be rated as specified.

☰ On the step 4 screen on page 412, the number next to the rating mark goes up to only three digits (max. 999). If there are 1000 or more images with a given rating, "###" will be displayed.

## ☰ Taking Advantage of Ratings

- With [▶2: Set image search conditions] and [▶2: Image jump w/ ☺], you can display only the images given a specific rating.
- Depending on the computer's operating system, you can see each file's rating as part of the file information display or in the provided, standard image viewer (JPEG images only).

## Quick Control for Playback

During playback, you can press the  button to set the following: [: **Protect images**], [: Rotate image], [: **Rating**], [: RAW image processing (**RAW** images only)], [: Resize (JPEG image only)], [: Cropping (JPEG images only)], [: **Highlight alert**], [: **AF point display**], [: Image jump w/ ], [: Image search], and [: **Send images to smartphone\***].

For movies, **only the functions in bold above** can be set.

\* Not selectable if [**Wi-Fi**] is set to [**Disable**] in [**Wi-Fi setting**] under [**1: Wireless communication settings**].

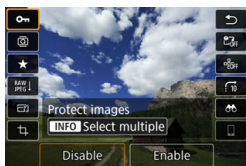





### 1 Press the button.

- During image playback, press the  button.
- ▶ The Quick Control options will appear.









### 2 Select an item and set it.

- Press the  <  keys to select a function.
- ▶ The setting of the selected function is displayed at the bottom.
- Turn the  or  dial to set it.
- For protecting images (p.409) and Rating (p.412), press <INFO> to set it.
- For RAW image processing (p.438), Resize (p.444), Cropping (p.446), Image search (p.402), and Send images to smartphone, press <SET> to set it.
- To cancel, press the <MENU> button.

### 3 Exit the setting.

- Press the < > button to exit the Quick Control.

 To rotate an image, set [**1: Auto rotate**] to [**On**  ] (p.435). If [**1: Auto rotate**] is set to [**On** ] or [**Off**], the [**Rotate image**] setting will be recorded to the image, but the camera will not rotate the image for display.

- 
- Pressing the < > button during the index display will switch to the single-image display, and the Quick Control screen will appear. Pressing the < > button again will return to the index display.
  - For images taken with another camera, the options you can select may be restricted.

## Enjoying Movies

The three main ways to play back and enjoy movies are as follows:

### Playback on a TV Set (p.427)



By connecting the camera to a TV set with an HDMI cable, you can play back the camera's still photos and movies on the TV set. Using the HDMI Cable HTC-100 (sold separately) is recommended.

- Even if the camera is connected to a TV set with an HDMI cable and a 4K time-lapse movie is played back, it will be played back in Full HD quality. (Playback in 4K quality is not possible.)
- Since hard disk recorders do not have an HDMI IN terminal, the camera cannot be connected to a hard disk recorder with an HDMI cable.
- Even if the camera is connected to a hard disk recorder with a USB cable, movies and still photos cannot be played back or saved.

### Playback on the Camera's LCD Monitor (p.419)



You can play back movies on the camera's LCD monitor.

You can also edit out the movie's first and last scenes and can play back the still photos or movies on the card in an automatic slide show.

- A movie edited with a computer cannot be rewritten to the card and played back with the camera.

## Playback and Editing with a Computer



The movie files recorded on the card can be transferred to a computer and played back or edited with pre-installed or general-purpose software compatible with the movie's recording format.

- To play back or edit a movie with commercially-available software, use software compatible with MP4-format and MOV-format movies. For details on commercially-available software, contact the software manufacturer.
- You can play back 4K time-lapse movies with EOS MOVIE Utility (p.595).

## ▶▶▶ Playing Back Movies



### 1 Play back the image.

- Press the <▶> button to play back an image.



### 2 Select a movie.

- Turn the <◉> dial to select the movie to be played back.
- In the single-image display, the <SET ▶▶▶> icon displayed on the upper left indicates a movie. If the movie is a video snapshot, <SET ▶▶▶> will be displayed.
- In the index display, perforations at the left edge of a thumbnail indicate a movie. **As movies cannot be played back from the index display, press <SET> to switch to the single-image display.**

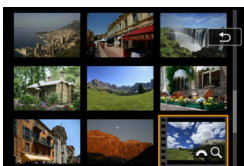

### 3 In the single-image display, press <SET>.

- ▶ The movie playback panel will appear at the bottom of the screen.



### 4 Play back the movie.

- Select [▶] (Play), then press <SET>.
- ▶ The movie will start playing back.
- You can pause the playback by pressing <SET>. Press it again to resume the playback.
- You can adjust the sound volume even during movie playback by turning the <◉> dial.
- For more details on the playback procedure, see the next page.

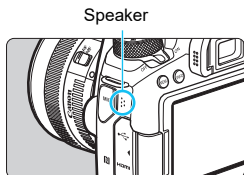

📄 If the search conditions are set with [▶▶▶ 2: Set image search conditions] (p.402), only the filtered images in step 2 will be displayed.

## Movie Playback Panel

Operation	Playback Description
▶▶▶ <b>Play*</b>	Pressing <ⓈⓔṬ> toggles between playback and stop.
▶▶▶ <b>Slow motion</b>	Adjusts the slow motion speed by turning the <ⓈⓔṬ> dial. The slow motion speed is indicated on the upper right of the screen.
◀◀◀ <b>First frame</b>	Displays the movie's first frame.
◀◀◀ <b>Previous frame</b>	Displays the previous frame each time you press <ⓈⓔṬ>. Holding <ⓈⓔṬ> down will rewind the movie.
▶▶▶ <b>Next frame</b>	Plays the movie frame-by-frame each time you press <ⓈⓔṬ>. Holding <ⓈⓔṬ> down will fast forward the movie.
▶▶▶ <b>Last frame</b>	Displays the movie's last frame.
🎵 <b>Background music</b>	Plays back a movie with the selected background music (p.426).
✂ <b>Edit</b>	Displays the editing screen (p.422).
	Playback position
mm' ss"	Playback time (minutes:seconds)
📶 <b>Volume</b>	Turn the <ⓈⓔṬ> dial to adjust the volume of the built-in speaker (p.419).
<b>MENU</b> ↩	Returns to the single-image display when <MENU> button is pressed.

\* For 4K time-lapse movie playback, the item name will be **[Play (Frame skip)]**.



## Playback with the Touch Screen

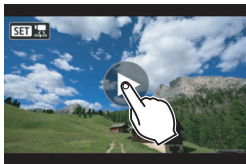

### Tap [▶] at the center of the screen.

- ▶ The movie will start playing back.
- To display the movie playback panel, tap <SET [▶]> or <SET [⏸]> on the upper left of the screen.
- To pause the movie while it is playing back, tap on the screen. The movie playback panel will also appear.



- If you play back a 4K time-lapse movie on the camera, the playback resolution will be equivalent to that of a Full HD movie played back on the camera.
- If you play back a 4K time-lapse movie with the camera or select [**Slow motion**] and set it to the fastest speed (by turning <⦿> all the way to the right), every other frame will be skipped during playback.
- The camera may not be able to play back movies shot with another camera.
- If you connect the camera to a TV set to play back a movie (p.427), adjust the sound volume with the TV set. (Turning the <🔊> dial will not change the sound volume.)
- If you attach or detach the lens, the card's writing speed is slow, or the movie file contains corrupted frames during movie playback, the movie playback will stop.
- If [**Background music**] is set, the sound recorded with the movie will not be played during the movie playback.



- For 4K time-lapse movies, when you select [▶] on the movie playback panel, [**Play (Frame skip)**] will be displayed.
- With a fully-charged Battery Pack LP-E6N, the continuous playback time at room temperature (23°C/73°F) will be approx. 4 hr. 40 min. (with [FHD]/[HD] set).

## ✂ Editing a Movie's First and Last Scenes

You can edit out the first and last scenes of a movie in approx. 1-sec. increments.



### 1 On the movie playback screen, select [✂].

- ▶ The movie editing panel will be displayed at the bottom of the screen.



### 2 Specify the part to be edited out.

- Select either [✂] (Cut beginning) or [✂] (Cut end), then press <SET>.
- Press the <◀> <▶> keys to see the previous or next frames. Keep holding down the key to fast forward or fast rewind the frames. Turn the <⌚> dial for frame-by-frame playback.
- After deciding which part to edit out, press <SET>. The portion highlighted in white on the top of the screen is what will remain.



### 3 Check the edited movie.

- Select [▶] and press <SET> to play back the edited movie.
- To change the edited part, go back to step 2.
- To cancel the editing, press the <MENU> button, then select [OK] on the confirmation dialog.



## 4 Save the edited movie.

- Select [**⏏**], then press < (SET) >.
- ▶ The save screen will appear.
- To save it as a new movie, select [**New file**]. To save it and overwrite the original movie file, select [**Overwrite**], then press < (SET) >.
- On the confirmation dialog, select [**OK**] to save the edited movie and return to the movie playback screen.



- Since the editing is performed in approx. 1-sec. increments (position indicated by [**✂**] on the top of the screen), the actual position where the movie is edited may differ from the position you specified.
- If the card does not have enough free space, [**New file**] will not be available.
- When the battery level is low, movie editing is not possible. Use a fully-charged battery.
- Movies shot with another camera cannot be edited with this camera.
- You cannot edit a movie when the camera is connected to a computer.

## MENU Slide Show (Auto Playback)

You can play back the images on the card as an automatic slide show.

### 1 Specify the images to be played back.

- To play back all the images on the card, go to step 2.
- If you want to specify the images to be played back in the slide show, filter the images with [**Set image search conditions**] under the [▶2] tab (p.402).

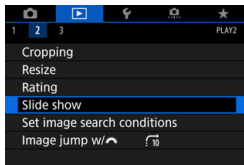

### 2 Select [Slide show].

- Under the [▶2] tab, select [**Slide show**], then press <SET>.

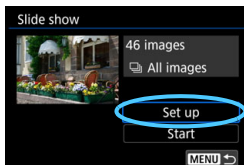

### 3 Set the playback as desired.

- Select [**Set up**], then press <SET>.
- Set the [**Display time**], [**Repeat**] (repeated playback), [**Transition effect**] (effect when changing images), and [**Background music**] for the still photos.
- For [**Background music**], see page 426.
- After completing the settings, press the <MENU> button.

#### Display time

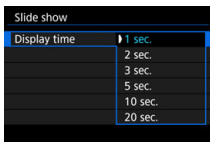

#### Repeat

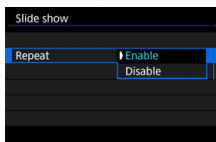

### Transition effect

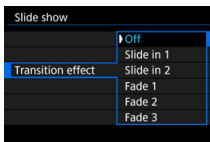

### Background music

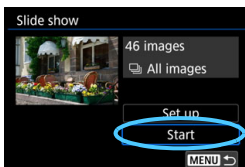
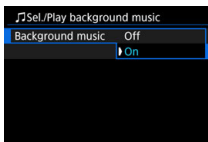

## 4 Start the slide show.

- Select **[Start]**, then press **<SET>**.
- ▶ After **[Loading image...]** is displayed, the slide show will start.

## 5 Exit the slide show.

- To exit the slide show and return to the setting screen, press the **<MENU>** button.



- When images for playback are already filtered (search conditions are set) with **[▶] 2: Set image search conditions**, the images matching the search conditions will be played back in the slide show.
- To pause the slide show, press **<SET>**. During pause, **[III]** will be displayed on the upper left of the image. Press **<SET>** again to resume the slide show. You can also pause the slide show by tapping on the screen.
- During the automatic playback of still photos, you can press the **<INFO>** button to switch the display format (p.388).
- During movie playback, you can adjust the sound volume by turning the **<VOLUME>** dial.
- During auto playback or pause, you can turn the **<DISP>** dial to view another image.
- During auto playback, auto power off will not take effect.
- The display time may differ depending on the image.
- To view the slide show on a TV set, see page 427.

## Selecting the Background Music

If you use EOS Utility (EOS software, p.594) to copy background music tracks to the card, you can play the background music together with the slide show.

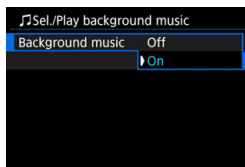

### 1 Select [Background music].

- Set [Background music] to [On], then press <SET>.
- If the card has no background music, you cannot perform step 2.

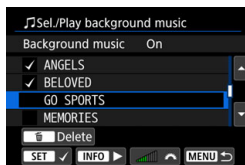

### 2 Select the background music.

- Press the <▲> <▼> keys to select the desired background music.
- To listen to a sample of a background music track, press the <INFO> button. During playback, press the <▲> <▼> keys to play another background music track. Press the <INFO> again to stop playing the background music track.
- Adjust the sound volume by turning the <☀> dial.
- Select a background music track and press <SET> to add a checkmark [✓]. You can also select multiple background music tracks.
- The checkmarked [✓] background music will be played for the slide show.



- At the time of purchase, the camera does not have background music. For the procedure to save (copy) the background music tracks to a card, refer to the EOS Utility Instruction Manual (p.596).
- To delete the background music tracks saved on the card, press the <☒> button in step 2.

## Viewing Images on a TV Set

By connecting the camera to a TV set with an HDMI cable, you can play back the camera's still photos and movies on the TV set. For the HDMI cable, HDMI Cable HTC-100 (sold separately) is recommended.

If the picture does not appear on the TV screen, check if the [F3: Video system] is correctly set to [For NTSC] or [For PAL] (depending on the video system of your TV set).

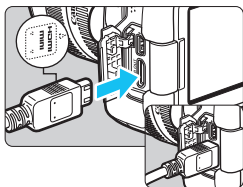

### 1 Connect the HDMI cable to the camera.

- With the plug's <▲HDMI MINI> logo facing the front of the camera, insert it into the <HDMI OUT> terminal.

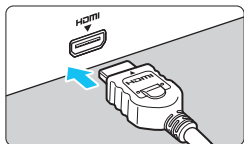

### 2 Connect the HDMI cable to the TV set.

- Connect the HDMI cable to the TV set's HDMI IN port.

### 3 Turn on the TV set and switch the TV set's video input to select the connected port.

### 4 Set the camera's power switch to <ON>.

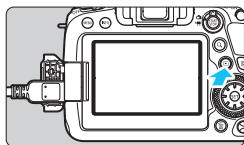

### 5 Press the <▶> button.

- ▶ The image will appear on the TV screen. (Nothing will be displayed on the camera's LCD monitor.)
- The images will automatically be displayed at the optimum resolution matching the connected TV set.
- By pressing the <INFO> button, you can change the display format.
- To play back movies, see page 419.

- When the camera is connected to a TV set with an HDMI cable, 4K time-lapse movies will be played back in Full HD quality (cannot be played back in 4K quality).
- Adjust movie sound volume with the TV set. The sound volume cannot be adjusted with the camera.
- Before connecting or disconnecting the cable between the camera and TV set, turn off the camera and TV set.
- Depending on the TV set, part of the image displayed may be cut off.
- Do not connect any other device's output to the camera's <HDMI OUT> terminal. Doing so may cause a malfunction.
- Certain TV sets may not display the images due to incompatibility.

### Using HDMI CEC TV Sets

If the TV set connected to the camera with an HDMI cable is compatible with HDMI CEC\*, you can use the TV set's remote control for playback operations.

\* An HDMI-standard function enabling HDMI devices to control each other so that you can control them with one remote control unit.

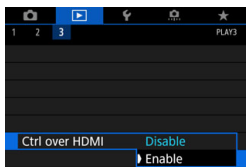

- 1 Select [Ctrl over HDMI].**
  - Under the [▶3] tab, select [Ctrl over HDMI], then press <Ⓢ>.
- 2 Select [Enable].**
- 3 Connect the camera to a TV set.**
  - Use an HDMI cable to connect the camera to the TV set.
  - ▶ The TV set's input will switch automatically to the HDMI port connected to the camera. If it does not switch automatically, use the TV set's remote control to select the HDMI IN port the cable is connected to.



## 4 Press the camera's <▶> button.

- ▶ An image will appear on the TV screen and you can use the TV set's remote control for playback.

## 5 Select an image.

- Point the remote control toward the TV set and press the ←/→ button to select an image.

### Still photo playback menu



### Movie playback menu



- : Return
- : 9-image index
- : Play back movie
- : Slide show
- INFO** : Display shooting info
- : Rotate

## 6 Press the remote control's Enter button.

- ▶ The menu appears and you can perform the playback operations shown on the left.
- Press the remote control's ←/→ button to select the desired option, then press the Enter button.
- If you select [**Return**] and press the Enter button, the menu will disappear and you can use the remote control's ←/→ button to select an image.



- Certain TV sets require you to first enable the HDMI CEC connection. For details, refer to the TV set's Instruction Manual.
- Certain TV sets, even those compatible with HDMI CEC, may not be able to be operated properly. In such a case, set [**▶3: Ctrl over HDMI**] to [**Disable**], and use the camera to control the playback operation.
- You can set the images to be played back when [**Slide show**] is selected with [**▶2: Set image search conditions**].



## Erasing Images

You can either select and erase unnecessary images one by one or erase them in one batch. Protected images (p.409) will not be erased.

 Once an image is erased, it cannot be recovered. Make sure you no longer need the image before erasing it. To prevent important images from being erased accidentally, protect them. Note that erasing a RAW+JPEG image will erase both the RAW and JPEG images.

### Erasing a Single Image

#### 1 Select the image to be erased.

- Press the < > button to play back images.
- Turn the < > dial to select the image to be erased.

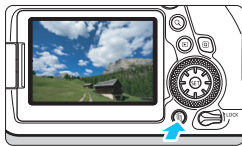

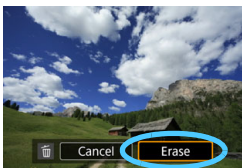

#### 2 Press the < > button.

- ▶ The Erase menu will appear.



#### 3 Erase the image.

- Select [Erase], then press < >. The image displayed will be erased.

 If the search conditions are set with [ 2: Set image search conditions] (p.402), only the found images will be displayed.

**MENU Checkmarking [✓] Images to Be Erased in a Batch**

By adding checkmarks <✓> to the images to be erased, you can erase all those images at once.

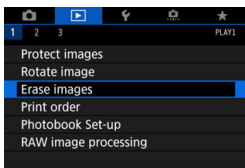
**1 Select [Erase images].**

- Under the [▶ 1] tab, select [Erase images], then press <SET>.

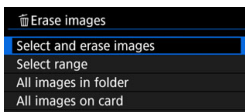
**2 Select [Select and erase images].**

- An image will be displayed.

**3 Select the image to be erased.**

- Turn the <◂> dial to select the image to be erased, then press <SET>.
- A checkmark [✓] will be displayed on the upper left of the screen.
- If you press the <Q> button and turn the <◂> dial counterclockwise, you can select an image from a three-image display. To return to the single-image display, turn the dial clockwise.
- To select another image to be erased, repeat step 3.

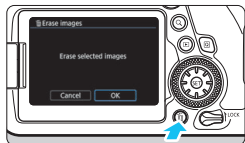
**4 Erase the image.**

- Press the <trash> button, then press [OK].
- The selected images will be erased at once.

Under [▶ 2: Set image search conditions], if [Protect] is set to [Enable], [▶ 1: Erase images] cannot be selected.

## MENU Specifying the Range of Images to be Erased

While looking at the images in the index display, you can specify the first and last images for a range to erase all the specified images at once.

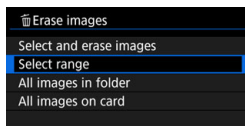

### 1 Select [Select range].

- Select [Select range] in [▶ 1: Erase images], then press <SET>.



### 2 Specify the range of images.

- Select the first image (start point), then press <SET>.
- Next, select the last image (end point), then press <SET>.
- ▶ A checkmark [✓] will be appended to all the images within the specified range.

### 3 Press the <Eraser> button.

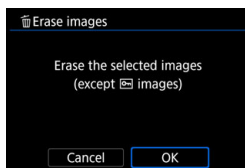

### 4 Erase the image.

- Select [OK].
- ▶ The images in the specified range will be erased.

If the search conditions are set with [▶ 2: Set image search conditions] (p.402), only the found images will be displayed.

## MENU Erasing All Images in a Folder or on a Card

You can erase all the images in a folder or on a card at once.

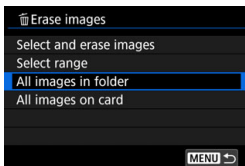

When [▶ 1: Erase images] is set to [All images in folder] or [All images on card], all the images in the folder or on the card will be erased.

If the search conditions are set with [▶ 2: Set image search conditions] (p.402), the display will change to [All found images].

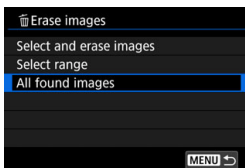

If you select [All found images], all the found images will be erased as specified.

 To erase all the images including protected images, format the card (p.70).

## **MENU** Adjusting the LCD Monitor Brightness

You can adjust the brightness of the LCD monitor to make it easier to view.

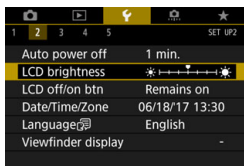

### **1** Select [LCD brightness].

- Under the [**2**] tab, select [**LCD brightness**], then press <SET>.

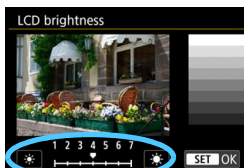

### **2** Adjust the brightness.

- Referring to the gray chart, press the <◀> <▶> keys to adjust the brightness, then press <SET>.

- To check the image's exposure, referring to the histogram is recommended (p.398).
- The last image played back will be displayed on the screen in step 2.

## MENU Setting the Auto Rotation of Vertical Images

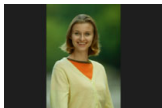

Images shot in vertical orientation are rotated automatically to the proper orientation for viewing, so they will not be displayed in horizontal orientation when played back on the camera's LCD monitor or viewed on a computer screen. You can change the setting of this feature.

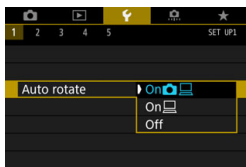

### 1 Select [Auto rotate].

- Under the [**1**] tab, select [**Auto rotate**], then press <SET>.

### 2 Set the display orientation.

- Select the desired setting, then press <SET>.

- **On**  

The vertical image is automatically rotated during playback on both the camera's LCD monitor and on the computer.

- **On** 

The vertical image is automatically rotated only on the computer.

- **Disable**

The vertical image is not automatically rotated.



Images captured with auto rotation set to [**Off**] will not rotate during playback even if you later set auto rotation to [**On**].



- The image displayed immediately after shooting will not be automatically rotated.
- If a picture is taken while the camera is pointing up or down, automatic rotation to the proper orientation for viewing may not be performed correctly.
- If the vertical image is not automatically rotated on the computer screen, it means the software you are using does not support image rotation for display. Using the EOS software is recommended.

---

---

---

---

---

---

---

---

---

---

---

---

---

---

---

---

---

---

---

---

---

---

---

---

---

---

---



# 11

## Post-Processing Images

This chapter describes RAW image processing, JPEG image resizing, and JPEG image cropping.

- The ☆ icon at the upper right of the page title indicates that the function is available only in Creative Zone modes (<P>, <Tv>, <Av>, <M>, <B>).



- The camera may not be able to process images taken with another camera.
- Post-processing images as described in this chapter cannot be performed when the camera is connected to a computer with an interface cable (sold separately).

## RAW/JPEG ↓ Processing RAW Images with the Camera ☆

You can process **RAW** images with the camera and save them as JPEG images. As the RAW image itself does not change, you can apply different processing conditions to create any number of JPEG images from it.

**Note that M RAW and S RAW images cannot be processed with the camera.** Use Digital Photo Professional (EOS software, p.594) to process those images.

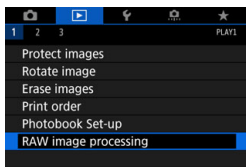

### 1 Select [RAW image processing].

- Under the [▶] 1 tab, select [**RAW image processing**], then press <SET>.
- RAW** images will be displayed.



### 2 Select the image to be processed.

- Turn the <⦿> dial to select the image you want to process.
- If you press the <Q> button and turn the <⚙> dial counterclockwise, you can select an image from the index display.



### 3 Set the desired processing conditions.

- Press <SET> and wait until the RAW-processing options appear (p.441).
- Use <⦿> to select an option, then turn the <⚙> or <⦿> dial to switch the setting.
- The displayed image will reflect such settings as “Brightness adjustment”, “White balance”, etc.
- To return to the image settings at the time of shooting, press the <INFO> button.



## Displaying the setting screen

- Press **<SET>** to display the selected function's setting screen. Turn the **<DISP/OK>** or **<DISP/OK>** dial to change the setting. Press **<SET>** to finalize the setting and return to the previous screen.



## 4 Save the image.

- Select **[L]** (Save), then press **<SET>**.
- When you select **[OK]**, the JPEG image created by the processing will be saved to the card.
- Check the destination folder and image file number, then select **[OK]**.
- To process another image, repeat steps 2 to 4.

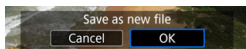

## Magnified View

You can magnify the image by pressing the <Q> button in step 3. The magnification will vary depending on the [Image quality] setting under [▶ 1: RAW image processing]. With <⦿>, you can scroll around the magnified image.







To cancel the magnified view, press the <Q> button again.

## Images with Aspect Ratio Setting

With [📷 4: Aspect ratio] (p.168) set to an option other than [3:2], frame lines indicating the image area will be displayed on the shot RAW images. JPEG images generated from RAW images will be saved with the set aspect ratio.

📌 When you process multiple-exposure RAW images, certain settings cannot be changed.

## RAW Image Processing Options

-  **Brightness adjustment**  
You can adjust the image brightness up to  $\pm 1$  stop in 1/3-stop increments. The displayed image will reflect the setting's effect.
-  **White balance** (p.185)  
You can select the white balance. If you select [**AWB**] and press the <INFO> button, you can select [**Auto: Ambience priority**] or [**Auto: White priority**]. If you select [**K**] and press the <INFO> button, you can set the color temperature. The displayed image will reflect the setting's effect.
-  **Picture Style** (p.176)  
You can select the Picture Style. By pressing the <INFO> button, you can adjust the sharpness, contrast, and other parameters. The displayed image will reflect the setting's effect.
-  **Auto Lighting Optimizer** (p.194)  
You can set the Auto Lighting Optimizer. The displayed image will reflect the setting's effect.
-  **High ISO speed noise reduction** (p.195)  
You can set the noise reduction processing for high ISO speeds. The displayed image will reflect the setting's effect. If the effect is difficult to discern, magnify the image (p.440).
-  **Image quality** (p.162)  
You can set the image quality when creating a JPEG image.

- sRGB **Color space** (p.208)

You can select either sRGB or Adobe RGB. Since the camera's LCD monitor is not compatible with Adobe RGB, the difference in the image will hardly be perceptible when either color space is set.

-  **Lens aberration correction**

- OFF **Peripheral illumination correction** (p.200)

A phenomenon that makes the image corners look darker due to the lens characteristics can be corrected. If **[Enable]** is set, the corrected image will be displayed. If the effect is difficult to discern, magnify the image (p.440) and check the four corners.

The peripheral illumination correction applied with the camera will be less pronounced than that applied with the Digital Photo Professional (EOS software, p.594) at maximum correction amount. If the effects of correction are not apparent, use Digital Photo Professional to apply the peripheral illumination correction.

-  OFF **Distortion correction** (p.202)

Image distortion due to lens characteristics can be corrected. If **[Enable]** is set, the corrected image will be displayed. The image periphery will be trimmed in the corrected image.

Since the image resolution may look slightly lower, adjust the sharpness with the Picture Style's **[Sharpness]** parameter setting as necessary.

-  OFF **Chromatic aberration correction** (p.201)

Chromatic aberrations (color fringing along the subject's outline) due to the lens characteristics can be corrected. If **[Enable]** is set, the corrected image will be displayed. If the effect is difficult to discern, magnify the image (p.440).

-  OFF **Diffraction correction** (p.203)

The diffraction by the lens aperture degrading the image sharpness can be corrected. If **[Enable]** is set, the corrected image will be displayed. If the effect is difficult to discern, magnify the image (p.440).



- Processing RAW images in the camera will not produce exactly the same results as processing RAW images with Digital Photo Professional (EOS software).
- If you perform **[Brightness adjustment]**, noise, banding, etc. may be intensified with the effects of adjustment.
- When processing images with **[Distortion correction]** set to **[Enable]**, AF point display information (p.397) or Dust Delete Data (p.452) will not be appended to the image.
- The effect of the lens aberration correction varies depending on the lens used and shooting conditions. Also, the effect may be difficult to discern depending on the lens used, shooting conditions, etc.



The lens correction data for lens aberration corrections is registered (stored) in the camera.

## Resizing JPEG Images

You can resize a JPEG image to make the pixel count lower and save it as a new image. Resizing an image is possible only with JPEG **L**, **M**, and **S1** images. **JPEG S2 and RAW images cannot be resized.**

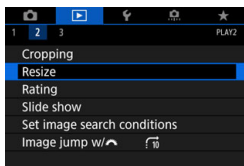

### 1 Select [Resize].

- Under the [**2**] tab, select [**Resize**], then press <SET>.
- ▶ An image will be displayed.



### 2 Select an image.

- Turn the <DISP> dial to select the image you want to resize.
- If you press the <Q> button and turn the <DISP> dial counterclockwise, you can select an image from the index display.



Target sizes

### 3 Select the desired image size.

- Press <SET> to display the image sizes.
- Select the desired image size, then press <SET>.

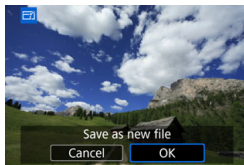

### 4 Save the image.

- Select [**OK**] to save the resized image.
- Check the destination folder and image file number, then select [**OK**].
- To resize another image, repeat steps 2 to 4.



## Resize Options by Original Image Quality

Original Image Quality	Available Resize Settings		
	M	S1	S2
L	<input type="radio"/>	<input type="radio"/>	<input type="radio"/>
M		<input type="radio"/>	<input type="radio"/>
S1			<input type="radio"/>

## Image Sizes

Sizes for resized images are shown below.

(Approx. pixels)

Image Quality	Full-frame (3:2)	4:3 (aspect ratio)
M	4160x2768* (11.5 megapixels)	3680x2768* (10.2 megapixels)
S1	3120x2080 (6.5 megapixels)	2768x2080* (5.8 megapixels)
S2	2400x1600 (3.8 megapixels)	2112x1600* (3.4 megapixels)

Image Quality	16:9 (aspect ratio)	1:1 (aspect ratio)
M	4160x2336* (9.7 megapixels)	2768x2768 (7.7 megapixels)
S1	3120x1752* (5.5 megapixels)	2080x2080 (4.3 megapixels)
S2	2400x1344* (3.2 megapixels)	1600x1600 (2.6 megapixels)



- The actual aspect ratio of images in the sizes marked with an asterisk "\*" will differ from the aspect ratio indicated.
- The image may be cropped slightly depending on the resizing conditions.

## 🔗 Cropping JPEG Images

You can crop a captured JPEG image and save it as another image. Cropping an image is possible only with JPEG L, M, S1, and S2 images. **Images shot in RAW cannot be cropped.**

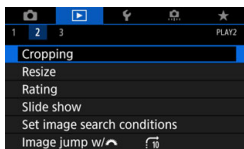

### 1 Select [Cropping].

- Under the [▶2] tab, select [Cropping], then press <SET>.
- ▶ An image will be displayed.

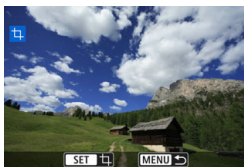

### 2 Select an image.

- Turn the <◉> dial to select the image you want to crop.
- If you press the <Q> button and turn the <☀> dial counterclockwise, you can select an image from the index display.



### 3 Set the cropping frame.

- Press <SET> to display the cropping frame.
- The image area within the cropping frame will be cropped.

#### • Changing the Cropping Frame Size

Turn the <☀> dial to change the cropping frame size. The smaller the cropping frame, the more magnified the cropped image will look.

#### • Changing the Aspect Ratio and Orientation

Turn the <◉> dial to change the cropping frame's aspect ratio. You can select the aspect ratio as follows: [3:2], [16:9], [4:3], or [1:1].

Turn the <◉> dial to change the orientation of the cropping frame. If you select [2:3], [9:16], or [3:4], you can crop a horizontal image to look as if it was shot in vertical orientation.

### ● Moving the Cropping Frame

Use <⬅➡> to move the frame over the image vertically or horizontally. Move the cropping frame until it covers the desired image area.

### ● Correcting the Tilt

You can correct image tilt by  $\pm 10^\circ$ . Press the <INFO> button, then while checking the tilt against the grid, turn the <⦿> dial (in  $0.1^\circ$  increments) or tap the left or right wedge (in  $0.5^\circ$  increments) on the upper left of the screen to correct the tilt. After completing the tilt correction, press <ⓈET>.



## 4 Check the image area to be cropped.

- Press the <[Q]> button.
- ▶ The image area to be cropped will be displayed.
- To return to the original display, press the <[Q]> button again.

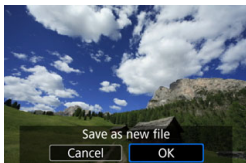

## 5 Save the image.

- Press <ⓈET>, then select [OK] to save the cropped image.
- Check the destination folder and image file number, then select [OK].
- To crop another image, repeat steps 2 to 5.



- The position and size of the cropping frame may change depending on the angle set for tilt correction.
- Once a cropped image is saved, it cannot be cropped again or resized.
- AF point display information (p.397) and Dust Delete Data (p.452) will not be appended to the cropped images.



# 12

## Sensor Cleaning

The camera has a Self Cleaning Sensor Unit to automatically shake off dust adhered to the image sensor's front layer (low-pass filter).

The Dust Delete Data can also be appended to the image so that the dust spots remaining can be deleted automatically by Digital Photo Professional (EOS software, p.594).

### **Smudges adhering to the front of the sensor**

Besides dust entering the camera from outside, in rare cases, lubricant from the camera's internal parts may adhere to the front of the sensor. If visible spots still remain after the automatic sensor cleaning, having the sensor cleaned by a Canon Service Center is recommended.

## Automatic Sensor Cleaning

Whenever you set the power switch to <ON> or <OFF>, the Self Cleaning Sensor Unit automatically shakes off the dust on the front of the sensor. Normally, you need not pay attention to this operation. However, you can manually perform sensor cleaning or can disable this unit as follows.

### Activating the Sensor Cleaning Manually

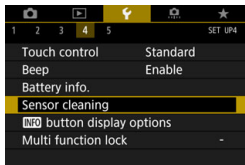

#### 1 Select [Sensor cleaning].

- Under the [4] tab, select [Sensor cleaning], then press <SET>.

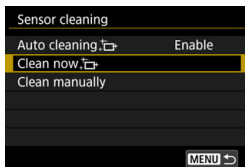



#### 2 Select [Clean now ].

- Select [Clean now ], then press <SET>.
- Select [OK].

- ▶ The screen will indicate that the sensor is being cleaned. (A small sound may be heard.) Although there will be a mechanical sound of the shutter during sensor cleaning, the picture will not be recorded to the card.
- ▶ After sensor cleaning is finished, the camera will automatically restart (turn off and on).



- For best results, perform the sensor cleaning with the camera placed upright and stable on a table or other flat surface.
- Even if you repeat the sensor cleaning, the result will not improve much. Immediately after the sensor cleaning is finished, the **[Clean now ** ] option remains disabled temporarily.
- Dots of light may appear on images if the sensor is affected by cosmic rays, etc. By selecting **[Clean now ** ], their appearance may be suppressed (p.565).

## Disabling Automatic Sensor Cleaning

- In step 2, select **[Auto cleaning ** ] and set it to **[Disable]**.
- ▶ The sensor will no longer be cleaned when you set the power switch to <ON> or <OFF>.

## MENU Appending Dust Delete Data ☆

Normally, the Self Cleaning Sensor Unit will eliminate most of the dust that may be visible on captured images. However, for the case where visible dust still remains, you can append the Dust Delete Data to the image for erasing the dust spots later. The Dust Delete Data is used by Digital Photo Professional (EOS software, p.594) to erase the dust spots automatically.

### Preparation

- Prepare a solid white object such as a sheet of paper.
- Set the lens focal length to 50 mm or longer.
- Set the lens's focus mode switch to <MF> and set the focus to infinity ( $\infty$ ). If the lens has no distance scale, rotate the camera to face toward you and turn the focusing ring clockwise all the way.

### Obtaining the Dust Delete Data

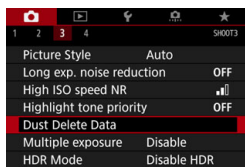

#### 1 Select [Dust Delete Data].

- Under the [CAMERA 3] tab, select [Dust Delete Data], then press <SET>.

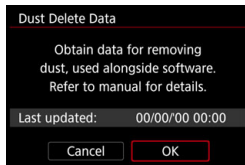

#### 2 Select [OK].

- ▶ After the automatic self-cleaning of the sensor is performed, a message will appear. Although there will be a mechanical sound of the shutter during the cleaning, no picture is taken.

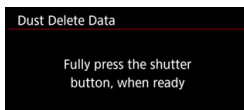
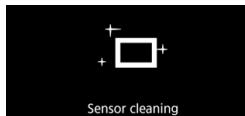





### 3 Shoot a solid-white object.

- At a distance of 20 cm - 30 cm (0.7 ft. - 1.0 ft.), fill the viewfinder with a patternless, solid-white object and take a picture.
- ▶ The picture will be taken in aperture-priority AE mode at an aperture of f/22.
- Since the image will not be saved, the data can still be obtained even if there is no card in the camera.
- ▶ When the picture is taken, the camera will start collecting the Dust Delete Data. When the Dust Delete Data is obtained, a message will appear.
- If the data is not obtained successfully, an error message will appear. Follow the “Preparation” procedure on the preceding page, then select [OK]. Take the picture again.

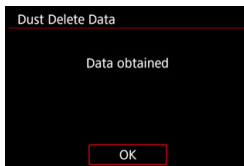

## Dust Delete Data

After the Dust Delete Data is obtained, it is appended to all the JPEG and RAW images captured thereafter. Before an important shoot, it is recommended that you update the Dust Delete Data by obtaining it again.

For details about using Digital Photo Professional (EOS software, p.594) to erase dust spots automatically, refer to the Digital Photo Professional Instruction Manual (p.596).

The Dust Delete Data appended to the image is so small that it hardly affects the image file size.

 Be sure to use a solid-white object such as a new sheet of white paper. If the object has any pattern or design, it may be recognized as dust data and affect the accuracy of the dust deletion with the Digital Photo Professional (EOS software).

## MENU Manual Sensor Cleaning ☆

Dust that could not be removed by the automatic sensor cleaning can be removed manually with a commercially-available blower, etc. Before cleaning the sensor, detach the lens from the camera.

**The image sensor is extremely delicate. If the sensor needs to be cleaned directly, having it done by a Canon Service Center is recommended.**

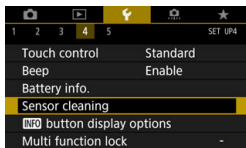

### 1 Select [Sensor cleaning].

- Under the [4] tab, select [Sensor cleaning], then press <SET>.

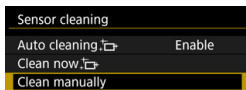

### 2 Select [Clean manually].



### 3 Select [OK].

- In a moment, the reflex mirror will lock up and the shutter will open.
- “CLn” will blink on the LCD panel.

### 4 Clean the sensor.

### 5 End the cleaning.

- Set the power switch to <OFF>.



If you will clean the sensor manually, make sure to use a fully-charged battery.



Using the household power outlet accessories (sold separately, p.520) is recommended.

- 
- **While cleaning the sensor, never do any of the following. If the power is cut off, the shutter will close and the reflex mirror will go back down. These may result in damaging the image sensor, shutter curtains, and reflex mirror.**
    - **Setting the power switch to <OFF>.**
    - **Removing or inserting the battery.**
  - The surface of the image sensor is extremely delicate. Clean the sensor with care.
  - Use a plain blower without any brush attached. A brush can scratch the sensor.
  - Do not insert the blower tip inside the camera beyond the lens mount. If the power is turned off, the shutter will close and the shutter curtains or reflex mirror may get damaged.
  - Never use pressurized air or gas to clean the sensor. Pressurized air may damage the sensor, and sprayed gas may freeze on the sensor and scratch it.
  - If the battery level becomes low while cleaning the sensor, the beeper will sound as a warning. Stop cleaning the sensor.
  - If a smudge that cannot be removed with a blower remains, having the sensor cleaned by a Canon Service Center is recommended.

# 13

## Print order and Photobook Set-up

---

- **Digital Print Order Format (DPOF)** (p.458)  
You can specify printing instructions such as the image selection, quantity to print, etc. for the images recorded on the card.
- **Specifying Images for a Photobook** (p.464)  
You can specify the images for printing in a photobook from those saved on the card.

# Digital Print Order Format (DPOF)

DPOF (Digital Print Order Format) enables you to print images recorded on the card according to your printing instructions such as the image selection, quantity to print, etc. You can print multiple images in one batch or create a print order for a photofinisher.

You can set the print settings such as print type, date imprinting, file number imprinting, etc. The print settings will be applied to all the images specified for printing. (They cannot be set individually for each image.)

## MENU Setting the Printing Options

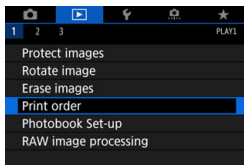

### 1 Select [Print order].

- Under the [▶] 1 tab, select [Print order], then press <SET>.

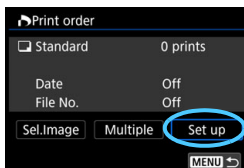

### 2 Select [Set up].

### 3 Set the options as desired.

- Set the [Print type], [Date], and [File No.].
- Select the option to be set, then press <SET>. Select the desired setting, then press <SET>.

#### Print type

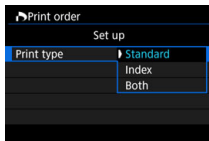



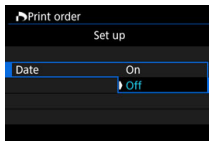

#### Date

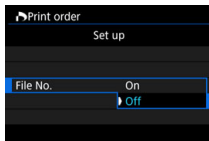

#### File number



Print type		Standard	Prints one image on one sheet.
		Index	Multiple thumbnail images are printed on one sheet.
	 	Both	Prints both the standard and index prints.
Date	On	[On] imprints the recorded date of the captured image.	
	Off		
File number	On	[On] imprints the file number.	
	Off		

#### 4 Exit the setting.

- Press the <MENU> button.
- ▶ The print order screen will reappear.
- Next, select [**Sel.Image**] or [**Multiple**] to order the images to be printed.

- RAW images or movies cannot be specified for printing.
- If you print an image with a large image size using the **[Index]** or **[Both]** setting (p.458), the index print may not be printed with certain printers. In such a case, resize the image (p.444), then print the index print.
- Even if **[Date]** and **[File No.]** are set to **[On]**, the date or file number may not be imprinted, depending on the print type setting and printer.
- With **[Index]** prints, the **[Date]** and **[File No.]** cannot both be set to **[On]** at the same time.
- When printing with DPOF, use the card for which print order specifications are set. You cannot print in the specified print order if you extract just the images from the card for printing.
- Certain DPOF-compliant printers and photofinishers may not be able to print the images as you specified. Refer to the printer's instruction manual before printing, or check with your photofinisher about compatibility when ordering prints.
- While installing images into this camera, do not specify a new print order for images that had a print order set by a different camera. All the print orders may be overwritten inadvertently. Also, the print order may not be possible, depending on the image type.

 You can send images from the camera via Wi-Fi to a PictBridge-compatible (Wireless LAN) printer and print the images (direct printing). For details, refer to the "Wi-Fi (Wireless Communication) Function Instruction Manual" (p.4).



## MENU Specifying Images for Printing

### Selecting Images

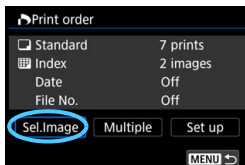

Select and specify the images one by one.

If you press the <Q> button and turn the <DIAL> dial counterclockwise, you can select an image from a three-image display. To return to the single-image display, turn the dial clockwise. Press the <MENU> button to save the print order to the card.

#### Standard / Both

Press <SET> to print a copy of the displayed image. By pressing the <▲> <▼> keys, you can set the number of copies to be printed up to 99.



#### Index

Press <SET> to add a checkmark to the box [✓]. The image will be included in the index print.



If the search conditions are set with [▶] 2: Set image search conditions] (p.402), only the found images will be displayed.

## ● Selecting Multiple Images

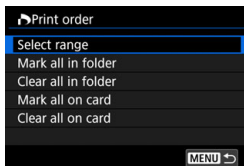

### ● Select Range

Under [**Multiple**], select [**Select range**]. Select the first and last images of the desired range, then all the images in the range will be marked with the checkmark [✓]. A print order for one copy of each image will be set.

If an image marked with [✓] is set as the first image, the images with [✓] within the range from the first image to the last will be canceled. (The specified range will have no [✓].)

### ● All Images in a Folder

Select [**Mark all in folder**] and select the folder. A print order for one copy of all the images in the folder will be specified.

If you select [**Clear all in folder**] and select the folder, the print order for all the images in the folder will be canceled.

### ● All Images on a Card

If you select [**Mark all on card**], one copy of all the images on the card will be specified for printing.

If you select [**Clear all on card**], the print order will be cleared for all the images on the card.

If the search conditions are set with [**▶2: Set image search conditions**] (p.402) and you select [**Multiple**], the display will change to [**Mark all found images**] and [**Clear all found images**].

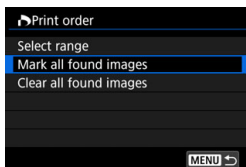

- **All found images**

If you select [**Mark all found images**], a print order for one copy of all the images filtered by the search will be set.

If you select [**Clear all found images**], the print order will be cleared for all the found images.



- RAW images or movies cannot be specified for printing. Note that RAW images or movies will not be specified for printing even if you specify all images with [**Multiple**].
- When using a PictBridge-compatible printer, do not specify more than 400 images for one print order. If you specify more than this, the images may not all be printed.



## Specifying Images for a Photobook

You can specify up to 998 images to be printed in a photobook. When you use EOS Utility (EOS software) to transfer images to a computer, the specified images for a photobook will be copied to a dedicated folder. This function is useful for ordering photobooks online.

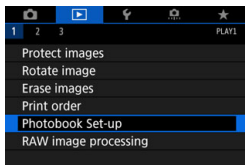
### **MENU** Specifying One Image at a Time



#### 1 Select [Photobook Set-up].

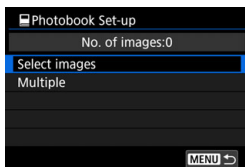

- Under the [ 1] tab, select [Photobook Set-up], then press < >.

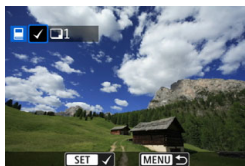

#### 2 Select [Select images].



#### 3 Select the image to be specified.

- Turn the < > dial to select the image to be specified for a photobook, then press < >.
- If you press the <Q> button and turn the < > dial counterclockwise, you can select an image from a three-image display. To return to the single-image display, turn the dial clockwise.
- To select other images to be specified for a photobook, repeat step 3.

## MENU Specifying the Image Range for a Photobook

While looking at the images in the index display, you can specify the first and last images for a range to all the specified images at once.

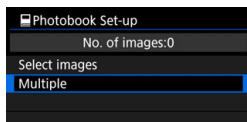

### 1 Select [Multiple].

- Under [▶ 1: Photobook set-up], select [Multiple], then press < (SET) >.

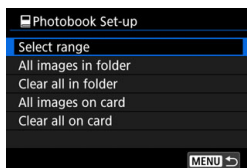

### 2 Select [Select range].



### 3 Specify the range of images.

- Select the first image (start point), then press < (SET) >.
- Next, select the last image (end point), then press < (SET) >.
- ▶ A checkmark [✓] will be appended to all the images within the specified range.
- To select other images to be specified for a photobook, repeat step 3.



- If the search conditions are set with [▶ 2: Set image search conditions] (p.402), only the found images will be displayed.
- If an image marked with the checkmark [✓] is set as the first image, the images with [✓] within the range from the first image to the last will be canceled. (The specified range will have no [✓].)

## MENU Specifying All Images in a Folder or on a Card

You can specify all the images in a folder or on a card at once for a photobook.

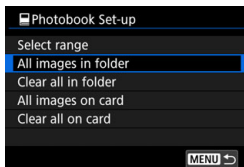

Under [▶ 1: Photobook Set-up], you can set [Multiple] to [All images in folder] or [All images on card] to specify all the images in the folder or on the card for a photobook.

To cancel the selection, select [Clear all in folder] or [Clear all on card].

If the search conditions are set with [▶ 2: Set image search conditions] (p.402) and you select [Multiple], the display will change to [All found images] and [Clear all found images].

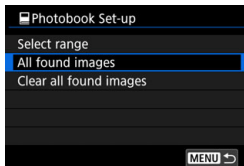

If you select [All found images], all the found images will be specified for the photobook.

If you select [Clear all found images], all the found images will be cleared for the photobook.

- RAW images or movies cannot be specified for the photobook. Note that RAW images or movies will not be specified for the photobook even if you specify all images with [Multiple].
- Do not specify images already specified for a photobook in another camera for another photobook with this camera. All the photobook settings may be overwritten inadvertently.

# 14

## Customizing the Camera

You can make fine adjustments to various camera functions and change the functionality of buttons and dials to suit your picture-taking preferences with Custom Functions and Custom Controls.

You can also save the camera's current settings to the <C1> and <C2> modes.

The functions described in this chapter are settable and usable in Creative Zone modes.

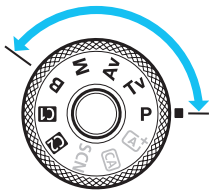

## MENU Setting Custom Functions ☆

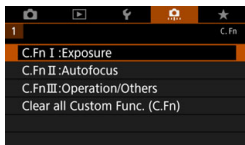

1 Select the [] tab.

2 Select the desired group.

- Select [**C.Fn I: Exposure**], [**C.Fn II: Autofocus**], or [**C.Fn III: Operation/Others**], then press < >.

Custom Function number

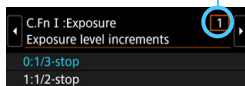

3 Select the Custom Function number.

- Press the < > < > keys to select the Custom Function number, then press < >.

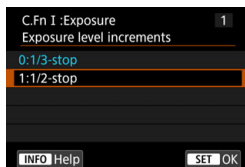

4 Change the setting as desired.

- Press the < > < > keys to select the desired setting (number), then press < >.
- Repeat steps 2 to 4 if you want to set another Custom Function.
- At the bottom of the screen, the current Custom Function settings are indicated below the respective function numbers.

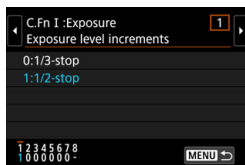

5 Exit the setting.

- Press the <**MENU**> button.
- ▶ The screen in step 2 will reappear.

### Clearing All Custom Functions



In step 2, selecting [**Clear all Custom Func. (C.Fn)**] will clear all the Custom Function settings.

Even if you perform [**Clear all Custom Func.(C.Fn)**], the settings for [**.C.Fn III-4: Custom Controls**] will not be cleared.





## MENU Custom Functions <sup>☆</sup>

### C.Fn I: Exposure

			 LV Shooting	 Movie Shooting
1	Exposure level increments	p.471	<input type="radio"/>	<input type="radio"/>
2	ISO speed setting increments		<input type="radio"/>	In <b>M</b>
3	Bracketing auto cancel		<input type="radio"/>	
4	Bracketing sequence	p.472	<input type="radio"/>	
5	Number of bracketed shots		<input type="radio"/>	
6	Safety shift	p.473	<input type="radio"/>	
7	Exposure compensation auto cancel	p.474	<input type="radio"/>	<input type="radio"/>
8	Metering mode, AE locked after focus		<input type="radio"/>	

### C.Fn II: AF

			 LV Shooting	 Movie Shooting
1	Tracking sensitivity	p.475		
2	Acceleration/deceleration tracking	p.476		
3	AF point auto switching	p.477		
4	AI Servo 1st image priority	p.478		
5	AI Servo 2nd image priority	p.479		
6	AF-assist beam firing	p.480	*1	*1*2
7	Lens drive when AF impossible	p.481		
8	Select AF area selection mode			



\*1: If an EX-series Speedlite (sold separately) equipped with an LED light is used, the AF-assist light will turn on when necessary.

\*2: Enabled only with time-lapse movie shooting.





Shaded Custom Functions do not function during Live View (LV) shooting or movie shooting. (Settings are disabled.)

**C.Fn II: AF**

			 LV Shooting	 Movie Shooting
9	AF area selection method	p.482		
10	Orientation linked AF point	p.483		
11	Initial AF point, (○) AI Servo AF	p.484		
12	Auto AF point selection: Color	p.485		
13	AF point selection movement	p.486		
14	AF point display during focus	p.487		
15	Viewfinder display illumination	p.488		
16	AF Microadjustment			

**C.Fn III: Operation/Others**

			 LV Shooting	 Movie Shooting
1	Warnings  in viewfinder	p.489		
2	Dial direction during Tv/Av	p.490	○	○
3	Retract lens on power off		○	○
4	Custom Controls		Depends on setting	

## MENU Custom Function Settings ☆

### C.Fn I: Exposure

#### C.Fn I-1 Exposure level increments

0: 1/3-stop

1: 1/2-stop

Sets 1/2-stop increments for the shutter speed, aperture, exposure compensation, AEB, flash exposure compensation, etc.



When [1:1/2-stop] is set, the display will be as shown below.



#### C.Fn I-2 ISO speed setting increments

0: 1/3-stop

1: 1-stop

You can change the manual ISO speed setting increments to a whole-stop.



- Even if [1: 1-stop] is set, ISO speed will be automatically set in 1/3-stop increments when ISO Auto is set.
- Even when [1: 1-stop] is set, you can set ISO 40000 (for still photo shooting).

#### C.Fn I-3 Bracketing auto cancel

0: Enable

When you set the power switch to <OFF>, the AEB and white balance bracketing settings will be canceled. AEB settings will also be canceled when the flash is ready to fire or if you switch to movie shooting.

1: Disable

The AEB and white balance bracketing settings will not be canceled even if you set the power switch to <OFF>. (If the flash is ready to fire or if you switch to movie shooting, AEB will be canceled temporarily, but the AEB range will be retained.)

## C.Fn I-4 Bracketing sequence

The AEB shooting sequence and white balance bracketing sequence can be changed.

**0:** 0 → - → +

**1:** - → 0 → +

**2:** + → 0 → -

AEB	White Balance Bracketing	
	B/A Direction	M/G Direction
0 : Standard exposure	0 : Standard white balance	0 : Standard white balance
- : Decreased exposure	- : Blue bias	- : Magenta bias
+ : Increased exposure	+ : Amber bias	+ : Green bias

## C.Fn I-5 Number of bracketed shots

The number of shots taken with AEB and white balance bracketing can be changed from the default 3 shots, to 2, 5, or 7 shots.

When [ **C.Fn I-4: Bracketing sequence**] is set to [0, -, +], the bracketed shots will be taken as shown in the table below.

**0: 3 shots**

**2: 5 shots**

**1: 2 shots**

**3: 7 shots**

(1-stop/step increments)

	1st Shot	2nd Shot	3rd Shot	4th Shot	5th Shot	6th Shot	7th Shot
3: 3 shots	Standard (0)	-1	+1				
2: 2 shots	Standard (0)	±1					
5: 5 shots	Standard (0)	-2	-1	+1	+2		
7: 7 shots	Standard (0)	-3	-2	-1	+1	+2	+3

 If [1: 2 shots] is set, you can select the + or - side when setting the AEB range. With WB bracketing, the 2nd shot will be adjusted toward either the B/A or M/G direction.

## C.Fn I-6 Safety shift

### 0: Disable

### 1: Shutter speed/Aperture

Takes effect in the <**Tv**> shutter-priority AE and <**Av**> aperture-priority AE modes. If the subject brightness changes and the standard exposure cannot be obtained within the autoexposure range, the camera will automatically change the manually-selected setting to obtain the standard exposure.

### 2: ISO speed

Works in the <**P**> Program AE, <**Tv**> shutter-priority AE, and <**Av**> aperture-priority AE modes. If the subject brightness changes and the standard exposure cannot be obtained within the autoexposure range, the camera will automatically change the manually set ISO speed to obtain the standard exposure.



- Under [**2: ISO speed settings**], even if [**ISO speed range**] or [**Min. shutter spd.**] is changed from the default setting, safety shift will override it if the standard exposure cannot be obtained.
- The minimum and maximum limits for the safety shift with the ISO speed are determined by [**Auto range**] under [**2: ISO speed settings**] (p.174). However, if the manually set ISO speed exceeds the [**Auto range**], the safety shift will take effect up or down to the manually set ISO speed.
- Safety shift will take effect as necessary even when flash is used.

## C.Fn I-7 Exposure compensation auto cancel

### 0: Disable

The exposure compensation setting will not be canceled even if you set the power switch to <OFF>.

### 1: Enable

When you set the power switch to <OFF>, the exposure compensation setting will be canceled.

## C.Fn I-8 Metering mode, AE locked after focus

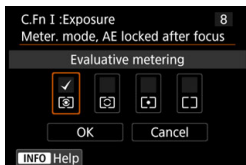

For each metering mode, you can set whether to lock the exposure (AE lock) after achieving focus with One-Shot AF by pressing the shutter button halfway. The exposure will be locked while you keep pressing the shutter button halfway. Checkmark [✓] the metering modes for when AE lock is to be applied. Select a metering mode [⊙]/[⊙]/[⊙]/[□], then press <SET> to append a checkmark [✓]. Select [OK] to register the setting.

## C.Fn II: AF

## C.Fn II-1 Tracking sensitivity

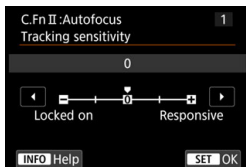

Sets the subject-tracking sensitivity during AI Servo AF when an obstacle cuts across the AF points or when the subject strays from the AF point.

0

Default setting. Suitable for moving subjects in general.

**Locked on: -2 / Locked on: -1**

The camera will try to continue focusing on the subject even if an obstacle cuts across the AF points or if the subject strays from the AF points. The -2 setting makes the camera keep tracking the target subject longer than the -1 setting.

However, if the camera focuses on a wrong subject, it may take slightly longer to switch and focus on the target subject.

**Responsive: +2 / Responsive: +1**

The camera can focus consecutively on subjects at different distances that are covered by the AF points. Also effective when you want to always focus on the closest subject. The +2 setting is more responsive than the +1 setting when focusing on the next subject.

However, the camera will be more prone to focus on an unintended subject.



[**C.Fn II-1: Tracking sensitivity**] is the same feature as [**AI Servo tracking sensitivity**] in the EOS-1D Mark III/IV, EOS-1Ds Mark III, and EOS 7D.

## C.Fn II-2 Acceleration/deceleration tracking

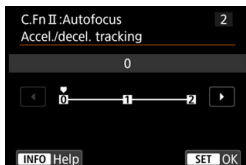

This sets the tracking sensitivity for moving subjects whose speed can momentarily change dramatically by starting or stopping suddenly, etc.

### 0

Suited for subjects that move at a steady speed (minor changes in moving speed).

### +2 / +1

Effective for subjects having sudden movements, sudden acceleration/deceleration, or sudden stops. Even if the moving subject's speed suddenly changes dramatically, the camera continues to focus on the target subject. For example, for an approaching subject, the camera becomes less prone to focus behind it to avoid subject blur. For a subject stopping suddenly, the camera becomes less prone to focus in front of it. Setting +2 can track dramatic changes in the moving subject's speed better than with +1.

However, since the camera will be sensitive to even slight movements of the subject, focusing may become unstable for short periods.



## C.Fn II-3 AF point auto switching

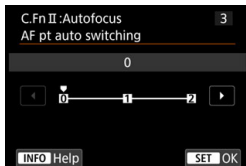

This sets the switching sensitivity of the AF points as they track the subject moving dramatically up, down, left, or right.

This setting takes effect when the AF area selection mode is set to Zone AF, Large Zone AF, or Automatic selection AF.

**0**

Standard setting for gradual AF point switching.

**+2 / +1**

Even if the target subject moves dramatically up, down, left, or right and moves away from the AF point, the camera switches its focus to neighboring AF points to continue focusing on the subject. The camera switches to the AF point deemed most likely to focus on the subject based on the subject's continual movement, contrast, etc. Setting +2 makes the camera more prone to switch the AF point than with +1.

However, with a wide-angle lens having a wide depth of field or if the subject is too small in the frame, the camera may focus with an unintended AF point.

## C.Fn II-4

## AI Servo 1st image priority

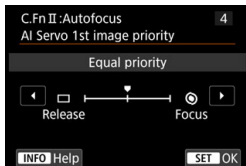

You can set the AF operation characteristics and shutter-release timing for the first shot with AI Servo AF.

**Equal priority**

Equal priority is given to focusing and shutter release.

**□: Release priority**

Pressing the shutter button takes the picture immediately even if focus has not been achieved. Useful when you want to give priority to capturing the decisive moment rather than achieving focus.

**⊙: Focus priority**

Pressing the shutter button does not take the picture until focus is achieved. Useful when you want to achieve focus before capturing the image.

## C.Fn II-5

## AI Servo 2nd image priority

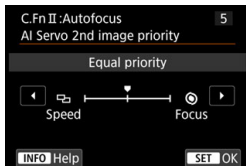

With AI Servo AF for continuous shooting, you can preset the AF operation characteristics and shutter-release timing for the subsequent shots after the first shot in continuous shooting.

### Equal priority

Equal priority is given to focusing and continuous shooting speed. In low light or with low-contrast subjects, continuous shooting speed may slow down.

### Shooting speed priority

Priority is given to the continuous shooting speed instead of achieving focus.

### Focus priority

Priority is given to achieving focus instead of the continuous shooting speed. The picture will not be taken until focus is achieved.



Even if [**Shooting speed priority**] is set, under shooting conditions that activate flicker reduction (p.206), the continuous shooting speed may become slower or the shooting interval may become irregular.



If focus cannot be achieved in low-light conditions when [**Equal priority**] is set, setting [**Focus priority**] may give better results.

## C.Fn II-6 AF-assist beam firing

Enables or disables the EOS-dedicated external Speedlite's AF-assist beam.

### 0: Enable

The external Speedlite emits the AF-assist beam when necessary.

### 1: Disable

The external Speedlite will not emit the AF-assist beam. This prevents the AF-assist beam from disturbing others.

### 2: IR AF assist beam only

When an external Speedlite is attached, only the infrared AF-assist beam will be emitted. Useful when you do not want to fire a series of small flashes as the AF-assist light (Intermittent flash method). With an EX-series Speedlite equipped with an LED light, the LED light will not automatically turn on as the AF-assist beam.

 If an external Speedlite's [AF-assist beam firing] Custom Function is set to [Disable], this function's setting will be overridden and the AF-assist beam will not be emitted.

## C.Fn II-7 Lens drive when AF impossible

If focus cannot be achieved with autofocus, you can have the camera keep searching for the precise focus or have it stop searching.

### 0: Continue focus search

If focus cannot be achieved with autofocus, the lens is driven to search for the precise focus.

### 1: Stop focus search

If autofocus starts and the focus is far off or if focus cannot be achieved, the lens drive will not be performed. This prevents the lens from becoming grossly out of focus due to the focus search drive.



When focus search drive is performed using a super telephoto lens or a lens with a wide focusing drive range, the lens can become grossly out of focus, and it may take more time to achieve focus next time. Setting [1: Stop focus search] is recommended.

## C.Fn II-8 Select AF area selection mode

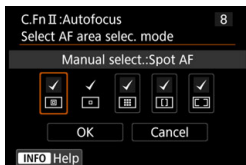

You can limit the selectable AF area selection modes to suit your shooting preferences. Select the desired AF area selection mode and press <SET> to add a checkmark [✓]. Then select [OK] to register the setting.

The AF area selection modes are described on pages 134-135.

- : Manual select.:Spot AF
- : Manual selection:1 pt AF
- : Manual select.:Zone AF
- : Manual select.:Large Zone AF
- : Auto selection AF





- The [✓] mark cannot be removed from [Manual selection:1 pt AF].
- If the attached lens belongs to group G or H, you cannot use certain AF area selection modes even if you add a checkmark [✓] in [Select AF area selec. mode].



## C.Fn II-9 AF area selection method



You can set the method for changing the AF area selection mode.

### 0: → AF area selection button

After you press the < > or < > button, pressing the < > button will change the AF area selection mode.

### 1: → Main Dial

After you press the < > or < > button, turning the < > dial will change the AF area selection mode.

 When [1:  → Main Dial] is set, use the < > to move the AF point horizontally.

## C.Fn II-10 Orientation linked AF point

You can set the AF point or the AF area selection mode + AF point separately for vertical shooting and horizontal shooting.

### 0: Same for both vert/horiz

The same AF area selection mode and manually-selected AF point (or zone) are used for both vertical shooting and horizontal shooting.

### 1: Separate AF pts: Area+pt

The AF area selection mode and AF point (or zone) can be set separately for each camera orientation (1. Horizontal, 2. Vertical with the camera grip at the top, 3. Vertical with the camera grip at the bottom). When you manually select the AF area selection mode and AF point (or zone) for each of the three camera orientations, they will be registered for the respective orientation. Whenever you change the camera orientation during shooting, the camera will switch to the AF area selection mode and manually-selected AF point (or zone) set for that orientation.

### 2: Separate AF pts: Pt only

The AF point can be set separately for each camera orientation (1. Horizontal, 2. Vertical with the camera grip at the top, 3. Vertical with the camera grip at the bottom). While using the same AF area selection mode, the AF point will switch automatically for the respective camera orientation.

When you manually select the AF point for each of the three camera orientations, it will be registered for the respective orientation.

During shooting, the AF point will switch to the manually-selected one depending on the camera orientation. By changing the AF area selection mode to Single-point Spot AF or Single-point AF, the AF point set for the respective orientation can be retained.

If you change the AF area selection mode to Zone AF or Large Zone AF, the zone will switch to the manually-selected one for the respective camera orientation.



- If [∅.: Clear all Custom Func. (C.Fn)] is selected (p.468), the settings for the 1., 2., and 3. orientations will be cleared.
- If you set this function and later attach a lens from a different AF group (p.145-148, particularly Group H), the setting may be cleared.

**C.Fn II-11 Initial AF Point,  AI Servo AF**

You can set the AI Servo AF's starting AF point for when the AF area selection mode is set to Auto selection AF.

**0: Auto**



The AF point that AI Servo AF starts with is set automatically to suit the shooting conditions.

**1: Initial  AF pt selected**

AI Servo AF will start with the manually-selected AF point when the AF operation is set to AI Servo AF and the AF area selection mode is set to Auto selection AF.

**2: Manual  AF pt**

If you switch from Single-point Spot AF or Single-point AF to Auto selection AF, AI Servo AF will start with the AF point that was manually selected before the switch. Useful if you want AI Servo AF to start with the AF point that was selected before the AF area selection mode is switched to Auto selection AF.

 When [2: Manual  AF pt] is set, AI Servo AF will start with the zone corresponding to the manually-selected AF point even if the AF area selection mode is switched to Zone AF or Large Zone AF.



## C.Fn II-12 Auto AF point selection: Color tracking

Use this function to autofocus by recognizing colors equivalent to skin tones. This function works when the AF area selection mode is set to Zone AF (manual selection of zone), Large Zone AF (manual selection of zone), or Automatic selection AF.

### 0: Enable

The camera selects AF points automatically based on AF information and information on colors equivalent to skin tones.

In One-Shot AF mode, focusing on a still human subject in the AF area is made easier.

In AI Servo AF mode, focusing on a human subject in the AF area is made easier. If no skin tones can be detected, the nearest subject will be focused on. Once focus is achieved, AF points are automatically selected so that the camera continues to focus on the color of the area it focused on first.

### 1: Disable

AF points are automatically selected based only on AF information.



- With setting [0: Enable], focusing will take slightly longer than with setting [1: Disable].
- Even with setting [0: Enable], the expected result may not be obtained depending on the shooting conditions and subject.
- Under so low light that the EOS-dedicated, external Speedlite emits the AF-assist beam automatically, AF points are selected automatically based only on AF information. (Human skin-tone color information is not used for AF.)

**C.Fn II-13 AF point selection movement**





You can set either to stop the selection at the outer edge or it can cycle around to the opposite side in AF point selection.

**0: Stops at AF area edges**

Useful if you often use an AF point along the edge.

**1: Continuous**

Instead of stopping at the outer edge, the selection of AF point continues to the opposite side.

 With [ **C.Fn II-11: Initial AF pt**,  **AI Servo AF**] set to [**1: Initial**  **AF pt selected**], the above setting will also work when you are selecting the initial AF point for AI Servo AF.

## C.Fn II-14 AF point display during focus

You can set whether to display the AF point(s) before AF starts (shooting ready), when AF starts, during AF, when focus is achieved, and when the metering timer is active after focus is achieved.

- 0 : Selected (constant)**
- 1 : All (constant)**
- 2 : Selected (pre-AF,focused)**
- 3 : Selected AF pt (focused)**
- 4 : Disable display**

○: Displayed, ×: Not displayed

AF point display during focus	With AF point selected	Before AF starts (shooting ready)	At AF start
<b>0: Selected (constant)</b>	○	○	○
<b>1: All (constant)</b>	○	○	○
<b>2: Selected (pre-AF,focused)</b>	○	○	○
<b>3: Selected AF pt (focused)</b>	○	×	○
<b>4: Disable display</b>	○	×	×

AF point display during focus	During AF	Focus achieved	Metering active after achieving focus
<b>0: Selected (constant)</b>	○	○	○
<b>1: All (constant)</b>	○	○	○
<b>2: Selected (pre-AF,focused)</b>	×	○	○
<b>3: Selected AF pt (focused)</b>	×	○	×
<b>4: Disable display</b>	×	×	×

## C.Fn II-15 Viewfinder display illumination

You can set whether the AF points in the viewfinder will light up in red when focus is achieved.

### 0: Auto

The AF points achieving focus in low light or with a dark subject will automatically light up in red.

### 1: Enable

The AF points light up in red regardless of the ambient light level.

### 2: Disable

The AF points do not light up in red.

AF point during AI Servo AF	
Non illuminated	OFF
Illuminated	ON

With [**Auto**] or [**Enable**] set, you can set whether the AF point is to light up in red when you press the <Q> button during AI Servo AF.

### OFF: Non illuminated

The AF points will not light up during AI Servo AF.

### ON: Illuminated

The AF points used for focusing light up in red during AI Servo AF. The AF points also light up during continuous shooting. If set to [**2: Disable**], this function will not work.



- When you press the <[AF-ON]> or <[Q]> button, the AF points will be illuminated in red regardless of this setting.
- The aspect ratio lines, electronic level, and grid in the viewfinder and the information set with [**Show/hide in viewfinder**] (p.82) will also light up in red.

## C.Fn II-16 AF Microadjustment

You can make fine adjustments for the AF's point of focus. For details, see page 491.

## C.Fn III: Operation/Others

### C.Fn III-1 Warnings in viewfinder

When any of the following functions are set, the  icon can be displayed in the viewfinder and on the LCD panel (p.31).

Select the function for which you want the warning icon to appear, then press  to add a checkmark [✓]. Then select [OK] to register the setting.

#### When monochrome is set

If [3: Picture Style] is set to [Monochrome] (p.178), the warning icon will appear.

#### When WB is corrected

If white balance correction is set (p.191), the warning icon will appear.

#### When is set

If [3: High ISO speed NR] is set to [Multi Shot Noise Reduction] (p.195), the warning icon will appear.

#### When HDR is set

If [3: HDR mode] is set (p.253), the warning icon will appear.







If you set any of the checkmarked [✓] functions,  will also appear for the respective setting displayed on the Quick Control screen (p.61).

## C.Fn III-2 Dial direction during Tv/Av

### 0: Normal

### 1: Reverse direction

Dial turning direction when setting the shutter speed and aperture can be reversed.

In the <M> shooting mode, the turning direction of the < > and < > dials will be reversed. In other shooting modes, the turning direction of only the < > dial will be reversed. The < > dial's turning direction in the <M> mode and the turning direction to set the exposure compensation in the <P>, <Tv>, and <Av> modes will be the same.

## C.Fn III-3 Retract lens on power off

This is to set the lens retraction mechanism for when a gear-driven STM lens (such as EF40mm f/2.8 STM) is attached to the camera. You can set it to retract the extended lens automatically when the camera's power switch is set to <OFF>.

### 0: Enable

### 1: Disable

-  ● With auto power off, the lens will not retract regardless of the setting.
- Before detaching the lens, make sure that it is retracted.

 When [0: Enable] is set, this function takes effect regardless of the lens's focus mode switch setting (AF or MF).

## C.Fn III-4 Custom Controls

You can assign frequently-used functions to camera buttons or dials according to your preferences. For details, see page 497.

## : Fine Adjustment of AF's Point of Focus <sup>☆</sup>

Fine adjustment of the AF's point of focus is possible for viewfinder shooting. This is called "AF Microadjustment". Before making the adjustment, read "General Cautions for AF Microadjustment" and "Notes for AF Microadjustment" on page 496.



 **Normally, this adjustment is not required. Perform this adjustment only if necessary. Note that performing this adjustment may prevent accurate focusing from being achieved.**

### 1: Adjust All by Same Amount

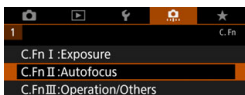
Set the adjustment amount manually by repeatedly making adjustments, shooting, and checking the results until the desired result is achieved. During AF, regardless of the lens used, the point of focus will always be shifted by the adjustment amount.



#### 1 Select [C.Fn II: Autofocus].

- Under the [>] tab, select [C.Fn II: Autofocus], then press < >.

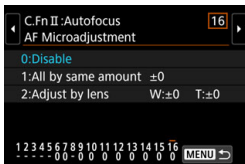

#### 2 Select [16: AF Microadjustment].

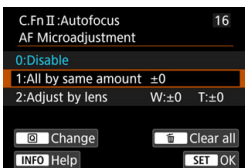

#### 3 Select [1: All by same amount].

#### 4 Press the < > button.

- The [1: All by same amount] screen will appear.

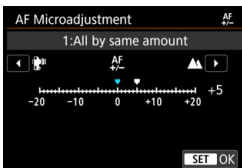

## 5 Make the adjustment.

- Set the adjustment amount. The adjustable range is  $\pm 20$  steps.
- Setting it toward “-: 📷 ” will shift the point of focus in front of the standard point of focus.
- Setting it toward “+: ▲ ” will shift the point of focus to behind the standard point of focus.
- After making the adjustment, press <SET>.
- Select [1: All by same amount], then press <SET>.

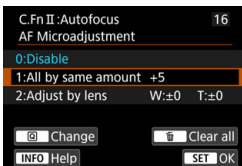

## 6 Check the result of the adjustment.

- Take a picture and play back the image (p.388) to check the adjustment result.
- If the shooting result comes out with focus in front of the targeted point, adjust toward the “+: ▲ ” side. If it comes out with focus behind the targeted point, adjust toward the “-: 📷 ” side.
- Repeat the adjustment as necessary.

🔍 If [1: All by same amount] is selected, separate AF adjustment will not be possible for the wide-angle and telephoto ends of zoom lenses.



## 2: Adjust by Lens

You can make the adjustment for each lens and register the adjustment in the camera. You can register the adjustment for up to 40 lenses.

When you autofocus with a lens whose adjustment is registered, the point of focus will always be shifted by the adjustment amount.

Set the adjustment amount manually by repeatedly making adjustments, shooting, and checking the results until the desired result is achieved. If you use a zoom lens, make the adjustment for the wide-angle (W) and telephoto (T) ends.

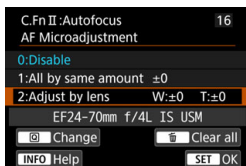

1 Select [2: Adjust by lens].

2 Press the <Q> button.

- ▶ The [2: Adjust by lens] screen will appear.

3 Check and change the lens information.

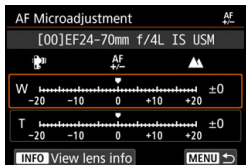

### Displaying the Lens Information

- Press the <INFO> button.
- ▶ The screen will show the lens name and a 10-digit serial number. When the serial number is displayed, select [OK] and go to step 4.
- If the lens's serial number cannot be confirmed, "0000000000" will be displayed. In this case, enter the number by following the instructions on the next page.
- Regarding the asterisk "\*" displayed in front of some lens serial numbers, see the next page.

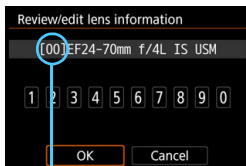

Registered number



### Entering the Serial Number

- Select the digit to be entered, then press <SET> so <☞> is displayed.
- Enter the number, then press <SET>.
- After entering all the digits, select [OK].

### Lens Serial Number

- In step 3, if “\*” appears in front of the 10-digit lens serial number, you can register only one unit of the same lens model. Even if you enter the serial number, “\*” will remain displayed.
- The serial number on the lens may differ from the serial number displayed on the screen in step 3. This is not a malfunction.
- If the lens serial number includes letters, enter only the numbers.
- If the lens serial number is eleven digits or longer, enter only the last ten digits.
- The location of the serial number varies depending on the lens.
- Certain lenses may not have a serial number inscribed. To register a lens that has no serial number inscribed, enter any serial number.



- If [2: Adjust by lens] is selected and an extender is used, the adjustment will be registered for the lens and extender combination.
- If 40 lenses have already been registered, a message will appear. After you select a lens whose registration is to be erased (overwritten), you can register another lens.

## Single focal length lens

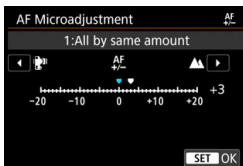

## Zoom lens

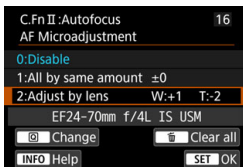
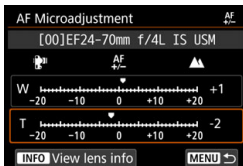

## 4 Make the adjustment.



- For a zoom lens, select the wide-angle (W) or telephoto (T) end. Pressing **<SET>** will turn off the orange frame and make the adjustment possible.
- Set the adjustment amount, then press **<SET>**. The adjustable range is  $\pm 20$  steps.
- Setting it toward “-: 📷” will shift the point of focus in front of the standard point of focus.
- Setting it toward “+: 📷” will shift the point of focus to behind the standard point of focus.
- For a zoom lens, repeat this procedure and adjust it for the wide-angle (W) and telephoto (T) ends.
- After completing the adjustment, press the **<MENU>** button to return to the screen in step 1.
- Select [**2: Adjust by lens**], then press **<SET>**.

## 5 Check the result of the adjustment.

- Take a picture and play back the image (p.388) to check the adjustment result.
- If the shooting result comes out with focus in front of the targeted point, adjust toward the “+: 📷” side. If it comes out with focus behind the targeted point, adjust toward the “-: 📷” side.
- Repeat the adjustment as necessary.

 When shooting with the intermediate range (focal length) of a zoom lens, the AF's point of focus is corrected automatically relative to the adjustments made for the wide-angle and telephoto ends. Even if only the wide-angle or telephoto end is adjusted, a correction will be made automatically for the intermediate range.

## Clearing All AF Microadjustments

When  **Clear all** appears at the bottom of the screen, pressing the  button will clear all the adjustments made for [1: **All by same amount**] and [2: **Adjust by lens**].

## Cautions for AF Microadjustment

- The AF's point of focus will vary slightly depending on the subject conditions, brightness, zoom position, and other shooting conditions. Therefore, even if you perform AF Microadjustment, focus may still not be achieved at the suitable position.
- The adjustment amount of one step varies depending on the maximum aperture of the lens. Keep adjusting, shooting, and checking the focus repeatedly to adjust the AF's point of focus.
- The adjustment will not be applied to AF in Live View shooting or movie shooting.
- The adjustments will be retained even if you do : **Clear all Custom Functions (C.Fn)** (p.468). However, the setting will be [0: **Disable**].

## Notes for AF Microadjustment



- It is best to make the adjustment at the actual location where you will shoot. This will make the adjustment more precise.
- Using a tripod when making the adjustment is recommended.
- For making adjustments, shooting at the  **L** image-recording quality is recommended.

# Custom Controls <sup>☆</sup>

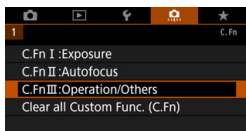
You can assign frequently-used functions to camera buttons or dials according to your preferences for easy operations.



## 1 Select [C.Fn III: Operation/Others].

- Under the [] tab, select [C.Fn III: Operation/Others], then press .

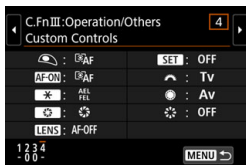

## 2 Select [4: Custom Controls].

- The Custom Controls setting screen will appear.

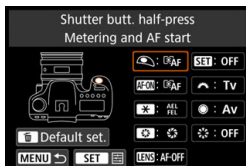

## 3 Select a camera button or dial.

- Select a camera button or dial, then press .
- The name of the camera control and the assignable functions will be displayed.
- The diagram on the left will show the location of the selected button or dial.







## 4 Assign a function.

- Select a function, then press .





## 5 Exit the setting.

- When you press  to exit the setting, the screen in step 3 will reappear.
- Press the  to exit.

 With the screen in step 3 displayed, you can press the  button to revert the Custom Control settings to their defaults. Note that the [ C.Fn III-4: Custom Controls] settings will not be canceled even if you select [ Clear all Custom Func. (C.Fn)].

## Assignable Functions to Camera Controls

Function		Page		AF-ON	
AF	<b>AF</b> <b>Metering and AF start</b>	500	<input type="radio"/>	<input type="radio"/>	<input type="radio"/>
	<b>AF-OFF</b> <b>AF stop</b>		<input type="radio"/>	<input type="radio"/>	<input type="radio"/>
	<small>ONE SHOT SERVO</small> <b>ONE SHOT ↔ AI SERVO/SERVO</b>		<input type="radio"/>	<input type="radio"/>	<input type="radio"/>
	<b>Direct AF point selection</b>		<input type="radio"/>	<input type="radio"/>	<input type="radio"/>
	<small>II SERVO AF</small> <b>Pause Movie Servo AF</b>		<input type="radio"/>	<input type="radio"/>	<input type="radio"/>
Exposure	<b>Metering start</b>	501	<input type="radio"/>	<input type="radio"/>	<input type="radio"/>
	<small>AEL FEL</small> <b>AE lock/FE lock</b>		<input type="radio"/>	<input type="radio"/>	<input type="radio"/>
	<b>AE lock (hold)</b>		<input type="radio"/>	<input type="radio"/>	<input type="radio"/>
	<b>AE lock</b>		<input type="radio"/>	<input type="radio"/>	<input type="radio"/>
	<b>AE lock (while button pressed)</b>		<input type="radio"/>	<input type="radio"/>	<input type="radio"/>
	<b>FEL</b> <b>FE lock</b>	502	<input type="radio"/>	<input type="radio"/>	<input type="radio"/>
	<b>ISO</b> <b>Set ISO speed (hold button, turn )</b>		<input type="radio"/>	<input type="radio"/>	<input type="radio"/>
	<b>Exposure compensation (hold button, turn )</b>		<input type="radio"/>	<input type="radio"/>	<input type="radio"/>
	<b>Flash exposure compensation</b>		<input type="radio"/>	<input type="radio"/>	<input type="radio"/>
	<b>Tv</b> <b>Shutter speed setting in M mode</b>		<input type="radio"/>	<input type="radio"/>	<input type="radio"/>
<b>Av</b> <b>Aperture setting in M mode</b>	<input type="radio"/>	<input type="radio"/>	<input type="radio"/>		
Images	<b>Image quality</b>	503	<input type="radio"/>	<input type="radio"/>	<input type="radio"/>
	<b>Picture Style</b>		<input type="radio"/>	<input type="radio"/>	<input type="radio"/>
	<b>WB</b> <b>White balance selection</b>		<input type="radio"/>	<input type="radio"/>	<input type="radio"/>
Operation	<b>Depth-of-field preview</b>	503	<input type="radio"/>	<input type="radio"/>	<input type="radio"/>
	<b>IS start</b>		<input type="radio"/>	<input type="radio"/>	<input type="radio"/>
	<b>MENU</b> <b>Menu display</b>		<input type="radio"/>	<input type="radio"/>	<input type="radio"/>
	<b>Flash function settings</b>	504	<input type="radio"/>	<input type="radio"/>	<input type="radio"/>
	<b>Wi-Fi function</b>		<input type="radio"/>	<input type="radio"/>	<input type="radio"/>
<b>OFF</b> <b>No function (disabled)</b>		<input type="radio"/>	<input type="radio"/>	<input type="radio"/>	

	LENS	SET			
	○				
○	○				
○	○				
					○
		○			
○	○				
○	○				
○	○				
○	○				
		○			
		○			
		○			
			○	○	
			○	○	
		○			
		○			
		○			
○		○			
○	○				
		○			
		○			
		○			
○		○			○



<LENS> stands for "AF stop button" provided on super telephoto lenses equipped with Image Stabilizer.

## AF

### **AF: Metering and AF start**

When you press the button assigned to this function, metering and AF are performed.

### **AF-OFF: AF stop**



The AF will stop while you hold down the button assigned to this function. Useful when you want to stop the AF during AI Servo AF.

### **ONE SHOT ↔ AI SERVO/SERVO**

You can switch the AF operation. In One-Shot AF mode, when you press the button to which this function is assigned, the camera switches to AI Servo AF/Servo AF mode. If you press the button in the AI Servo AF/Servo AF mode, the camera switches to One-Shot AF mode. Useful when you need to keep switching between One-Shot AF and AI Servo AF/Servo AF for a subject that keeps moving and stopping.

 This function does not work during Live View shooting if Multi Shot Noise Reduction is set.

### **Direct AF point selection**

When the metering timer is active, you can select an AF point directly with the  dial without pressing the  or  button.

### **Pause Movie Servo AF**

While Movie Servo AF is operating, pressing  will pause the AF. Press the button again to resume Movie Servo AF.



## Exposure

### : Metering start

When you press the shutter button halfway, exposure metering is performed. (AF is not performed.)

### : AE lock/FE lock

When you press the button assigned to this function, you can lock the exposure (AE lock) while the metering timer is active. Useful when you want to set the focus and exposure separately.

For flash photography, pressing the button assigned to this function will fire a preflash and retain the required flash output (FE lock).

### : AE lock

When you press the button assigned to this function, you can lock the exposure (AE lock) while the metering timer is active. Useful when you want to set the focus and exposure separately.

### : AE lock (while button pressed)

The exposure will be locked (AE lock) while you hold down the shutter button.



### : AE lock (hold)

When you press the button assigned to this function, you can lock the exposure (AE lock). The AE lock will be maintained until you press the button again. Useful when you want to set the focus and exposure separately or take multiple shots at the same exposure setting.

### **FEL: FE lock**

For flash photography, pressing the button assigned to this function will fire a preflash and retain the required flash output (FE lock).

### **ISO : Set ISO speed (hold button, turn )**

You can set the ISO speed by holding down the button assigned with this function and turning the  dial (works with still photo shooting only). If this control is used with ISO Auto set, you can set the ISO speed manually. When the metering timer () ends, ISO Auto will be restored. If you use this function in the **<M>** mode, you can adjust the exposure with the ISO speed while maintaining the current shutter speed and aperture value.



### **: Exposure compensation (hold button, turn )**

You can set the exposure compensation by turning the  dial while holding down the button assigned with this function. Useful when you want to set exposure compensation in **<M>** manual exposure with ISO Auto set.



### **: Flash exposure compensation**

By pressing **<SET>**, you can set the exposure compensation amount while looking at the exposure level indicator in the viewfinder or on the LCD panel.

### ****T<sub>v</sub>**: Shutter speed setting in M mode**

With **<M>** manual exposure, you can set the shutter speed with the  or  dial.

### ****A<sub>v</sub>**: Aperture setting in M mode**

With **<M>** manual exposure, you can set the aperture with the  or  dial.

## Image

### : Image quality

Press <> to display the recording quality setting screen (p.162) on the LCD monitor.

### : Picture Style

Press <> to display the Picture Style selection screen (p.176) on the LCD monitor.

### WB : White balance selection

Press <> to display the white balance setting screen (p.185) on the LCD monitor.

## Operation

### : Depth-of-field preview

When you press the depth-of-field preview button or <>, the aperture will stop down and you can check the depth of field (p.240).

### : IS start

With the lens's IS switch set to <ON>, if you press the depth-of-field preview button or the lens's AF stop button, the Image Stabilizer will operate.

### MENU: Menu display

Press <> to display the menu on the LCD monitor.

 : **Flash function settings**

Press <  > to display the flash function setting screen (p.283).

 : **Wi-Fi function**

Press <  > to display the wireless communication setting screen (p.540).

**OFF: No function (disabled)**

Use this setting when you do not want to assign any function to the button.

## MENU Registering My Menu ☆

Under My Menu tab, you can register menu items and Custom Functions whose settings you change frequently. You can also name the registered menu tabs, and press the <MENU> button to display the My Menu tab first.

### Creating and Adding My Menu Tab

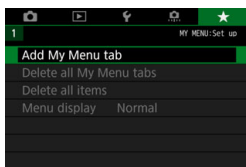

#### 1 Select [Add My Menu tab].

- Under the [★] tab, select [Add My Menu tab], then press <SET>.

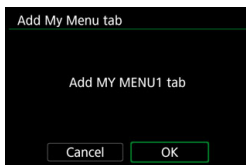

#### 2 Select [OK].

- ▶ The [MY MENU1] tab is created.
- You can create up to five My Menu tabs by repeating steps 1 and 2.

### Registering Menu Items under the My Menu Tab(s)



#### 1 Select [Configure: MY MENU\*].

- Press the <◀> <▶> keys to select [Configure: MY MENU\*] (tab for registering menu items), then press <SET>.

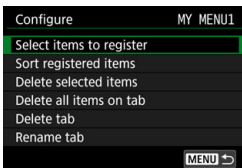

## 2 Select [Select items to register].

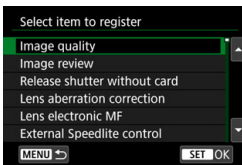

## 3 Register the desired items.

- Select the option to be set, then press <SET>.
- Select [OK] on the confirmation dialog.
- You can register up to six items.
- To return to the screen in step 2, press the <MENU> button.

## My Menu Tab Settings

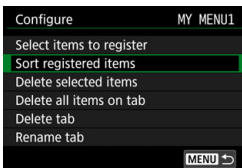

You can sort and delete items under the menu tab, and rename or delete the menu tab.

### • Sort registered items

You can change the order of the registered items in My Menu. Select [Sort registered items] and select the item whose order you want to change. Then press <SET>. With [◆] displayed, press the <▲> <▼> keys to change the order, then press <SET>.

### • Delete selected items / Delete all items on tab

You can delete any of the registered items. [Delete selected items] deletes one item at a time, and [Delete all items on tab] deletes all the registered items under the tab.

### ● Delete tab

You can delete the My Menu tab currently displayed. Select [**Delete tab**] to delete the [**MY MENU\***] tab.

### ● Rename tab

You can rename the My Menu tab from [**MY MENU\***].

## 1 Select [Rename tab].



Input mode

## 2 Enter text.

- Press the <[trash]> button to delete any unnecessary characters.
- Use <[left arrow]> or <[right arrow]> to move the  and select the desired character. Then press <[SET]> to enter it.
- By selecting [**Aa ↔ 1@**], you can change the input mode.
- You can enter up to 16 characters.
- To cancel the text entry, press the <[INFO]> button, then select [**OK**].

## 3 Exit the setting.

- After entering the text, press the <[MENU]> button, then select [**OK**].
- ▶ The set name is saved.



If you cannot enter text in step 2, press the <[Q]> button and use the character palette when the blue frame appears.

## Deleting all My Menu tabs / Deleting all items

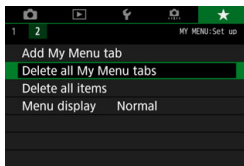

You can delete all the created My Menu tabs or My Menu items registered under them.

- **Delete all My Menu tabs**

You can delete all My Menu tabs you created. When you select **[Delete all My Menu tabs]**, all the tabs from **[MY MENU1]** to **[MY MENU5]** will be deleted and the **[★]** tab will revert to its default.

- **Delete all items**

You can delete all the items registered under the **[MY MENU1]** to **[MY MENU5]** tabs. The tab(s) will remain. When **[Delete all items]** is selected, all the items registered under all the created tabs will be deleted.

ⓘ If you perform **[Delete tab]** or **[Delete all My Menu tabs]**, tab names renamed with **[Rename tab]** will also be deleted.



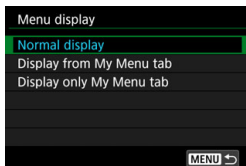

## Menu Display Settings



You can select [**Menu display**] to set the menu screen that is to appear first when you press the <MENU> button.



- **Normal display**  
Displays the last displayed menu screen.
- **Display from My Menu tab**  
Displays with the [★] tab selected.
- **Display only My Menu tab**  
Only the [★] tab is displayed. (The 📷, ▶, 🗑️, and 📶 tabs will not be displayed.)

## : Registering Custom Shooting Modes <sup>☆</sup>

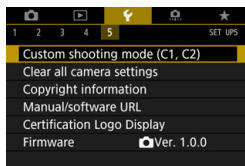
You can register current camera settings, such as the shooting functions, menu functions, and Custom Function settings, as Custom shooting modes under the Mode Dial's < > and < > positions.



### 1 Select [Custom shooting mode (C1, C2)].

- Under the [ 5] tab, select [**Custom shooting mode (C1, C2)**], then press < >.

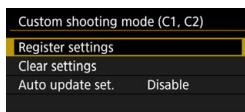

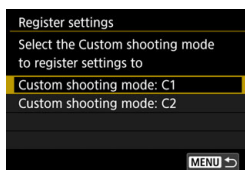

### 2 Select [Register settings].



### 3 Register the desired items.

- Select the Custom shooting mode to be registered, then press < >.
- Select [**OK**] on the confirmation dialog.
- ▶ The current camera settings (p.511) will be registered under the Mode Dial's C\* position.



## Automatic Update of Registered Settings

If you change a setting while you shoot in the < > or < > mode, the respective Custom shooting mode can be automatically updated to reflect the changes in the settings (Auto update). To enable this automatic update, set [**Auto update set.**] to [**Enable**] in step 2.

## Canceling Registered Custom Shooting Modes

If you select [**Clear settings**] in step 2, the settings of respective modes can be reverted to the default settings with no Custom shooting modes registered.

 My Menu settings will not be registered under Custom shooting modes.

 Even in the < > and < > modes, you can still change shooting function settings and menu settings.



## Settings To Be Registered

### ● Shooting Function Settings

Shooting mode, Shutter speed, Aperture, ISO speed, AF operation, AF area selection mode, AF point, Drive mode, Metering mode, Exposure compensation amount, AEB increment, Flash exposure compensation amount

### ● Menu Functions

[ 1] Image quality, Image review time, Release shutter without card, Lens aberration correction, Lens electronic MF, Flash firing, E-TTL II flash metering, Flash sync speed in Av mode

[ 2] Exposure compensation/AEB,  ISO speed settings, Auto Lighting Optimizer, White balance, Custom White Balance, White balance shift/bracketing, Color space

[ 3] Picture Style, Long exposure noise reduction, High ISO speed noise reduction, Highlight tone priority, Multiple exposure (settings), HDR Mode (settings)

[ 4] Interval timer, Bulb timer, Anti-flicker shooting, Mirror lockup, Aspect ratio, Live View shooting

[ 5 (Live View shooting)]  
AF method, Touch Shutter, Metering timer, Grid, Exposure simulation, Silent LV shoot.

[ 1 (Movie shooting)]  
Movie recording size, Image quality, Sound recording, Peripheral illumination correction, Chromatic aberration correction, Lens electronic MF

[ 2 (Movie shooting)]  
Exposure compensation,  ISO speed settings, Auto Lighting Optimizer, White balance, Custom White Balance, White balance shift

**[📷4 (Movie shooting)]**

Movie Servo AF, AF method, Movie Servo AF tracking sensitivity, Movie Servo AF speed, Metering timer, Grid,  button function

**[📷5 (Movie shooting)]**

Video snapshot, Time-lapse movie (setting), Movie digital IS, Remote control

[▶2] Slide show (settings), Image jump with 

[▶3] Highlight alert, AF point display, Playback grid, Histogram display, Magnification (approx.)

[🔍1] File numbering, Auto rotate

[🔍2] Auto power off, LCD brightness, LCD off/on button, Viewfinder display

[🔍3] Help text size

[🔍4] Touch control, Beep, Auto cleaning, **INFO** button display options/**INFO** button LV display options, Multi function lock

**[⋮1] C.Fn I**

Exposure level increments, ISO speed setting increments, Bracketing auto cancel, Bracketing sequence, Number of bracketed shots, Safety shift, Exposure compensation auto cancel, Metering mode, AE locked after focus

**C.Fn II**

Tracking sensitivity, Acceleration/deceleration tracking, AF point auto switching, AI Servo 1st image priority, AI Servo 2nd image priority, AF-assist beam firing, Lens drive when AF impossible, Select AF area selection mode, AF area selection method, Orientation linked AF point, Initial  AF point, AI Servo AF, Auto AF point selection: Color Tracking, AF point selection movement, AF point display during focus, VF display illumination, AF Microadjustment (excluding adjustment)

**C.Fn III**

Dial direction during Tv/Av, Retract lens on power off, Custom Controls

# 15

## Reference

This chapter provides reference information for system accessories, camera features, etc.



### Certification Logo

Select [**5: Certification Logo Display**] and press <SET> to display some of the logos of the camera's certifications. Other certification logos can be found in this Instruction Manual, on the camera body, and on the camera's package.

# System Map

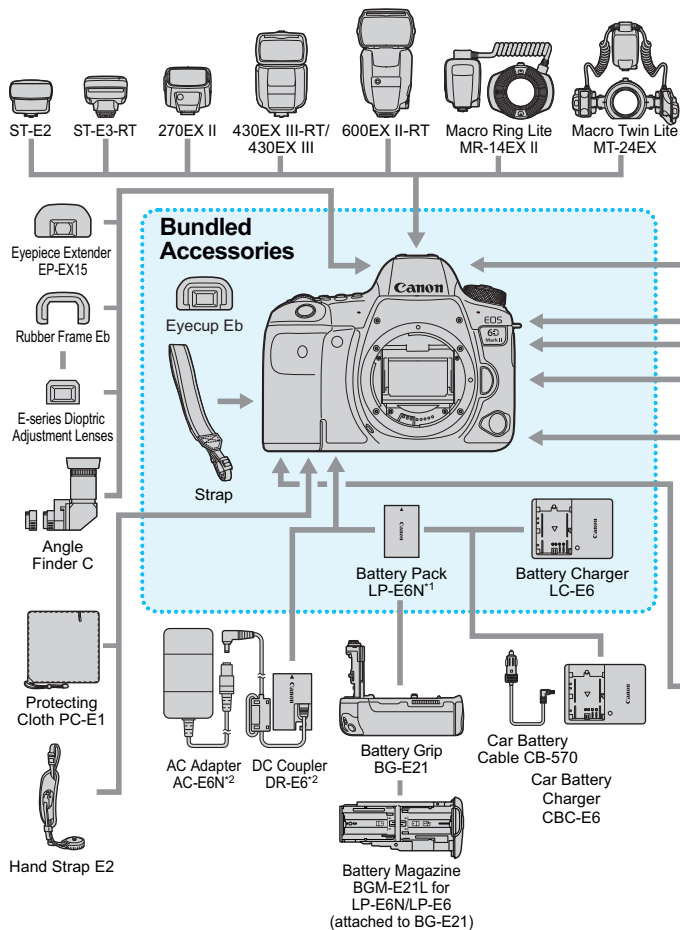

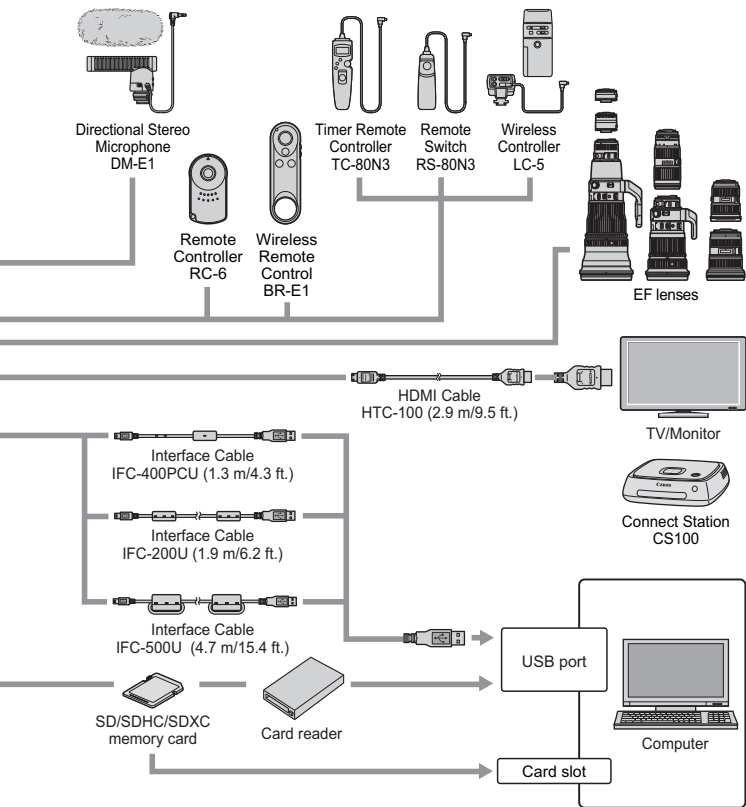

\*1: Battery Pack LP-E6 can also be used.

\*2: AC Adapter Kit ACK-E6 can also be used.

\* All cable lengths given are approximate figures.

## MENU Checking the Battery Information

You can check the conditions of the battery you are using on the LCD monitor. Each Battery Pack LP-E6N/LP-E6 has a unique serial number, and you can register multiple battery packs to the camera. When you use this feature, you can check the registered batteries' approximate remaining capacity and usage history.

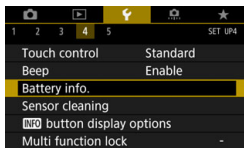

### Select [Battery info.].

- Under the [**4**] tab, select [**Battery info.**], then press <SET>.
- ▶ The battery information screen will appear.

### Battery position

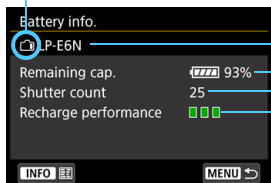

- Battery model or household power source being used.
- The battery level indicator (p.48) is displayed together with the remaining battery level shown in 1% increments.
- The number of shots taken with the current battery. The number is reset when the battery is recharged.
- Battery's recharge performance level is displayed in three levels.
  - (Green) : Battery's recharge performance is good.
  - (Green) : Battery's recharge performance is slightly degraded.
  - (Red) : Purchasing a new battery is recommended.

 Using a genuine Canon Battery Pack LP-E6N/LP-E6 is recommended. If you use batteries that are not genuine Canon products, the camera's full performance may not be attained or malfunction may result.

- The shutter count is the number of still photos taken. (Movie shooting is not counted.)
- The battery information will also be displayed when using Battery Grip BG-E21 (sold separately).
- If a battery communication error message is displayed, follow the instructions in the message.



## Registering Batteries to the Camera

You can register up to six LP-E6N/LP-E6 batteries to the camera. To register multiple batteries to the camera, follow the procedure below for each battery.

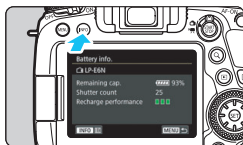

### 1 Press the **<INFO>** button.

- With the battery info. screen displayed, press the **<INFO>** button.
- ▶ The battery history screen will appear.
- ▶ If the battery is not registered, it will be grayed out.

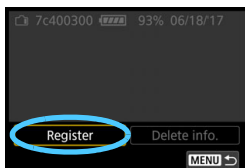

### 2 Select **[Register]**.

- ▶ The confirmation dialog will appear.

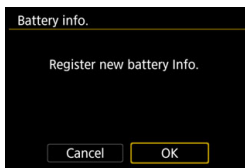

### 3 Select **[OK]**.

- ▶ The battery will be registered and the battery history screen will reappear.
- ▶ The grayed out battery number will now be displayed in white.
- Press the **<MENU>** button. The battery info. screen will reappear.



- The battery cannot be registered if the household power outlet accessories (sold separately, p.520) are used.
- If six batteries are already registered, **[Register]** cannot be selected. To delete unnecessary battery information, see page 519.

## Labeling Serial Numbers on Batteries

It is convenient to label each registered Battery Pack LP-E6N/LP-E6 with their serial numbers, using commercially-available labels.

Serial number

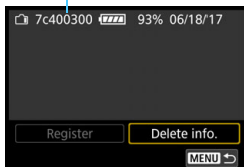

### 1 Write the serial number on a label.

- Write the serial number displayed on the battery history screen on a label approx. 25 mm x 15 mm / 1.0 in. x 0.6 in. in size.

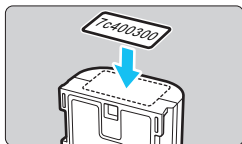

### 2 Remove the battery and affix the label.

- Set the power switch to <OFF>.
- Open the battery compartment cover and remove the battery.
- Affix the label as shown in the illustration (on the side with no electrical contacts).
- Repeat this procedure for all of your batteries so you can easily see the serial number.

- Do not affix the label on any part other than as shown in the illustration in step 2. Otherwise, the misplaced label may make it difficult to insert the battery or impossible to turn on the camera.
- If you use Battery Grip BG-E21 (sold separately), the label may peel off as you repeatedly insert and remove the battery into the battery magazine. If it peels off, affix a new label.

## Checking the Remaining Capacity of a Registered Battery

You can check the remaining capacity of any battery (even when not installed) and also when it was last used.

Serial number    Date last used

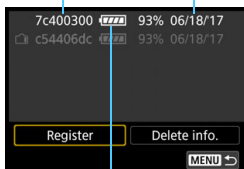

Battery level

### Look for the serial number.

- Refer to the battery's serial number label and look for the battery's serial number on the battery history screen.
- ▶ You can check the respective battery's remaining capacity and the date when it was last used.

## Deleting the Registered Battery Information

### 1 Select [Delete info.].

- Follow step 2 on page 517 to select [**Delete info.**], then press <SET>.

### 2 Select the battery information to be deleted.

- Select the battery information to be deleted, then press <SET>.
- ▶ [✓] will appear.
- To delete information for another battery, repeat this procedure.

### 3 Press the <trash> button.

- ▶ The confirmation dialog will appear.

### 4 Select [OK].

- ▶ The battery information will be deleted and the screen in step 1 will reappear.

## Using a Household Power Outlet

You can power the camera with a household power outlet by using the DC Coupler DR-E6 and AC Adapter AC-E6N (each sold separately).

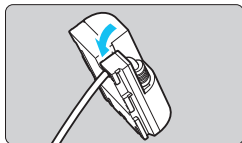

### 1 Place the cord in the groove.

- Carefully insert the DC coupler's cord into the groove without damaging the cord.

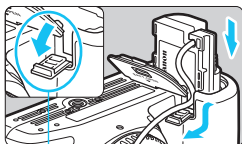

DC coupler cord hole

### 2 Insert the DC coupler.

- Open the battery compartment cover and open the DC coupler cord hole cover.
- Insert the DC coupler securely until it locks and put the cord through the hole.
- Close the cover.

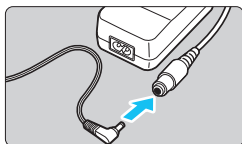

### 3 Connect the DC coupler to the AC adapter.

- Connect the DC coupler's plug to the AC adapter's connector securely.

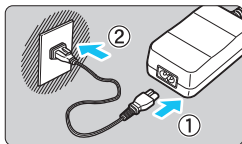

### 4 Connect the power cord.

- Connect the power cord to the AC adapter and insert the power plug into a power outlet.

### 5 Set the camera's power switch to <ON> (p.47).



- Do not use an AC adapter other than the AC-E6N (sold separately).
- While the camera's power switch is on, do not connect or disconnect the power cord or connector, or disconnect the DC coupler.
- After using the camera, unplug the power plug from the power outlet.



AC Adapter Kit ACK-E6 can also be used.

## Using Eye-Fi Cards

With a commercially-available Eye-Fi card already set up, you can automatically transfer captured images to a computer or upload them to an online service via a wireless LAN.

The image transfer is a function of the Eye-Fi card. For instructions on how to set up and use the Eye-Fi card or to troubleshoot any image transfer problems, refer to the Eye-Fi card's instruction manual or contact the card manufacturer.

**The camera is not guaranteed to support Eye-Fi card functions (including wireless transfer). In case of a problem with an Eye-Fi card, please check with the card manufacturer. Also note that approval is required to use Eye-Fi cards in many countries or regions. Without approval, use of the card is not permitted. If it is unclear whether the card has been approved for use in your area, please check with the card manufacturer.**

### 1 Insert an Eye-Fi card (p.43).

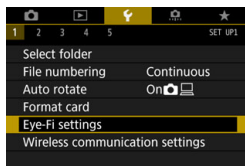

### 2 Select [Eye-Fi settings].

- Under the [**1**] tab, select [**Eye-Fi settings**], then press <SET>.
- This menu is displayed only when an Eye-Fi card is inserted into the camera.

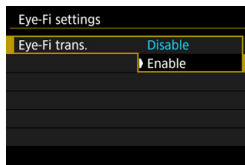

### 3 Enable Eye-Fi transmission.

- Select [**Eye-Fi trans.**], then press <SET>.
- Select [**Enable**], then press <SET>.
- If you set [**Disable**], there will be no automatic transmission even with the Eye-Fi card inserted (transmission status icon )

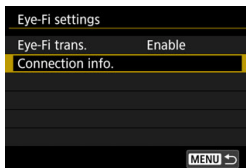

#### 4 Display the connection information.

- Select [**Connection info.**], then press <SET>.



#### 5 Check the [**Access point SSID:**].

- Check that an access point is displayed for [**Access point SSID:**].
- You can also check the Eye-Fi card's MAC address and firmware version.
- Press the <MENU> button to exit the menu.





Transmission status

#### 6 Take the picture.

- ▶ The picture is transferred and the [Wi-Fi] icon switches from gray (not connected) to one of the icons in the sequence below.
- For transferred images, [Wi-Fi] is displayed in the shooting information display (p.392).

- 📶 (Gray) **Not connected** : No connection with access point.
- 📶 (Blinking) **Connecting...** : Connecting to access point.
- 📶 (Illuminated) **Connected** : Connection to access point established.
- 📶 (1) **Transferring...** : Image transfer to access point in progress.

## Cautions for Using Eye-Fi Cards

- Under **[Wi-Fi settings]** of [**1: Wireless communication settings**], if **[Wi-Fi]** set to **[Enable]**, image transfer with an Eye-Fi card will not be possible.
- If "" is displayed, an error occurred while retrieving the card information. Turn the camera's power switch off and on again.
- Even if **[Eye-Fi trans.]** is set to **[Disable]**, it may still transmit a signal. In hospitals, on airplanes, and in other places where wireless transmissions are prohibited, remove the Eye-Fi card from the camera beforehand.
- If the image transfer does not function, check the Eye-Fi card and computer settings. For details, see the card's Instruction Manual.
- Depending on the wireless LAN's connection conditions, the image transfer may take longer or it may be interrupted.
- Because of the communication function, the Eye-Fi card may become hot.
- The camera's battery power will be consumed faster.
- During the image transfer, auto power off will not take effect.
- If you insert a wireless LAN card other than an Eye-Fi card, [**1: Eye-Fi settings**] will not appear. Also, the transmission status icon <> will not appear.



Lined writing area with 20 horizontal lines.



# Function Availability Table by Shooting Mode

## Still Photo Shooting (A+, CA, Creative Zone)

● : Set automatically ○ : User selectable □ : Not selectable/Disabled

Function		A+	CA	P	Tv	Av	M	B
Shooting with ambience selection			○					
Background blur setting			○					
Image-recording quality	RAW	○	○	○	○	○	○	○
	JPEG	○	○	○	○	○	○	○
Aspect ratio				○	○	○	○	○
ISO speed	Automatically set/Auto	●	●	○	○	○	○	○
	Manually set			○	○	○	○	○
Picture Style	Auto	●	●	○	○	○	○	○
	Manual selection			○	○	○	○	○
White balance	Auto	●	●	○	○	○	○	○
	Preset			○	○	○	○	○
	Custom			○	○	○	○	○
	Color temperature setting			○	○	○	○	○
Correction/Bracketing				○	○	○	○	○
Auto Lighting Optimizer		●	●	○	○	○	○	○
High ISO speed noise reduction		●	●	○	○	○	○	○
Long exposure noise reduction				○	○	○	○	○
Highlight tone priority				○	○	○	○	○
Lens aberration correction	Peripheral illumination correction	●	●	○	○	○	○	○
	Chromatic aberration correction	●	●	○	○	○	○	○
	Distortion correction			○	○	○	○	○
	Diffraction correction	●	●	○	○	○	○	○
Anti-flicker shooting <sup>*1</sup>		●	●	○	○	○	○	○
Color space	sRGB	●	●	○	○	○	○	○
	Adobe RGB			○	○	○	○	○
AF (Viewfinder shooting)	One-Shot AF			○	○	○	○	○
	AI Focus AF	●	●	○	○	○	○	○
	AI Servo AF			○	○	○	○	○
	AF area selection mode	○	○	○	○	○	○	○
	AF point selection	○	○	○	○	○	○	○
	Manual focusing (MF)	○	○	○	○	○	○	○
AF (Live View shooting)	One-Shot AF	●	●	○	○	○	○	○
	Servo AF			○	○	○	○	○
	⌂+Tracking	○	○	○	○	○	○	○
	Smooth zone	○	○	○	○	○	○	○
	Live 1-point AF	○	○	○	○	○	○	○
	Manual focusing (MF)	○	○	○	○	○	○	○

Function		A <sup>+</sup>	CA	P	Tv	Av	M	B
Drive	Single shooting	○	○	○	○	○	○	○
	High-speed continuous shooting	○	○	○	○	○	○	○
	Low-speed continuous shooting	○	○	○	○	○	○	○
	Silent single shooting* <sup>1</sup>	○	○	○	○	○	○	○
	Silent continuous shooting* <sup>1</sup>	○	○	○	○	○	○	○
	10-sec. self-timer/Remote control	○	○	○	○	○	○	○
	2-sec. self-timer/Remote control	○	○	○	○	○	○	○
	Self-timer: Continuous	○	○	○	○	○	○	○
Metering	Evaluative metering	●	●	○	○	○	○	○
	Partial metering			○	○	○	○	○
	Spot metering			○	○	○	○	○
	Center-weighted average metering			○	○	○	○	○
Exposure	Program shift			○				
	Exposure compensation			○	○	○	○* <sup>2</sup>	
	AEB			○	○	○	○	
	AE lock			○	○	○	○* <sup>3</sup>	
	Depth-of-field preview			○	○	○	○	○
	HDR shooting			○	○	○	○	
	Multiple exposures			○	○	○	○	○
	Interval timer* <sup>1</sup>	○	○	○	○	○	○	
	Bulb timer							○
	Mirror lockup* <sup>1</sup>			○	○	○	○	○
External flash	Flash on* <sup>4</sup>	●	●	○	○	○	○	○
	Flash off* <sup>4</sup>			○	○	○	○	○
	Flash exposure compensation			○	○	○	○	○
	FE lock* <sup>1</sup>			○	○	○	○	○
	Flash function settings			○	○	○	○	○
	Custom Function settings			○	○	○	○	○
GPS function	○	○	○	○	○	○	○	
Live View shooting	○	○	○	○	○	○	○	
Quick Control	○	○	○	○	○	○	○	
Touch operation	○	○	○	○	○	○	○	

\*1: Settable only with viewfinder shooting (enabled).

\*2: Settable only with ISO Auto set.







\*3: With ISO Auto, you can set a fixed ISO speed.

\*4: Settable with [Flash firing] under [External Speedlite control].







## Still Photo Shooting (SCN: )

● : Set automatically ○ : User selectable □ : Not selectable/Disabled







Function		SCN					
Brightness		○	○	○	○	○	○
Color tone							
Panning effect							○
Image-recording quality	RAW	○	○	○	○	○	○
	JPEG	○	○	○	○	○	○
Aspect ratio							
ISO speed	Automatically set/Auto	●	●	●	●	●	●
	Manually set						
Picture Style	Auto	●	●	●	●	●	●
	Manual selection						
White balance	Auto	●	●	●	●	●	●
	Preset						
	Custom						
	Color temperature setting						
	Correction/Bracketing						
Auto Lighting Optimizer		●	●	●	●	●	●
High ISO speed noise reduction		●	●	●	●	●	●
Long exposure noise reduction							
Highlight tone priority							
Lens aberration correction	Peripheral illumination correction	●	●	●	●	●	●
	Chromatic aberration correction	●	●	●	●	●	●
	Distortion correction		●				
	Diffraction correction	●	●	●	●	●	●
Anti-flicker shooting <sup>1</sup>		●	●	●	●	●	●
Color space	sRGB	●	●	●	●	●	●
	Adobe RGB						
AF (Viewfinder shooting)	One-Shot AF	●	●	●			
	AI Focus AF						
	AI Servo AF				●	●	●
	AF area selection mode	○	○	○	○	○	○
	AF point selection	○	○	○	○	○	○
	Manual focusing (MF)	○	○	○	○	○	○
AF (Live View shooting)	One-Shot AF	●	●	●			
	Servo AF				●	●	●
	⤵+Tracking	○	○	○	○	○	
	Smooth zone	○	○	○	○	○	●
	Live 1-point AF	○	○	○	○	○	
	Manual focusing (MF)	○	○	○	○	○	○







Function		SCN					
							
Drive	Single shooting	○	○	○	○	○	○
	High-speed continuous shooting	○	○	○	○	○	
	Low-speed continuous shooting	○	○	○	○	○	○
	Silent single shooting* <sup>1</sup>	○	○	○	○	○	○
	Silent continuous shooting* <sup>1</sup>	○	○	○	○	○	
	10-sec. self-timer/Remote control	○	○	○	○	○	○
	2-sec. self-timer/Remote control	○	○	○	○	○	○
	Self-timer: Continuous	○	○	○	○	○	○
Metering	Evaluative metering	●	●	●	●	●	●
	Partial metering						
	Spot metering						
	Center-weighted average metering						
Exposure	Program shift						
	Exposure compensation						
	AEB						
	AE lock						
	Depth-of-field preview						
	HDR shooting						
	Multiple exposures						
	Interval timer* <sup>1</sup>	○	○	○	○	○	○
	Bulb timer						
	Mirror lockup						
	External flash	Flash on	●	●	●	●	●
Flash off							●
Flash exposure compensation							
FE lock* <sup>1</sup>							
Flash function settings							
Custom Function settings							
GPS function	○	○	○	○	○	○	
Live View shooting	○	○	○	○	○	○	
Quick Control	○	○	○	○	○	○	
Touch operation	○	○	○	○	○	○	

\*1: Settable only with viewfinder shooting (enabled).

Still Photo Shooting (SCN:      

●: Set automatically ○: User selectable □: Not selectable/Disabled

Function		SCN					
							
Brightness		○	○	○	○	○	
Color tone			○	○			
Panning effect							
Image-recording quality	RAW	○	○	○	○		
	JPEG	○	○	○	○	○	○
Aspect ratio							
ISO speed	Automatically set/Auto	●	●	●	●	●	●
	Manually set						
Picture Style	Auto	●	●	●	●	●	●
	Manual selection						
White balance	Auto	●	●	●	●	●	●
	Preset						
	Custom						
	Color temperature setting						
	Correction/Bracketing						
Auto Lighting Optimizer		●	●	●	●	●	●
High ISO speed noise reduction		●	●	●	●	●	●
Long exposure noise reduction							
Highlight tone priority							
Lens aberration correction	Peripheral illumination correction	●	●	●	●	●	●
	Chromatic aberration correction	●	●	●	●	●	●
	Distortion correction						
	Diffraction correction	●	●	●	●	●	●
Anti-flicker shooting <sup>*1</sup>		●	●	●	●	●	●
Color space	sRGB	●	●	●	●	●	●
	Adobe RGB						
AF (Viewfinder shooting)	One-Shot AF	●	●	●	●	●	●
	AI Focus AF						
	AI Servo AF						
	AF area selection mode	○	○	●	○	○	○
	AF point selection	○	○	● <sup>+2</sup>	○	○	○
	Manual focusing (MF)	○	○	○	○	○	○
AF (Live View shooting)	One-Shot AF	●	●		●	●	●
	Servo AF						
	⌂+Tracking	○	○		○	○	○
	Smooth zone	○	○		○	○	○
	Live 1-point AF	○	○		○	○	○
	Manual focusing (MF)	○	○		○	○	○





Function		SCN					
							
Drive	Single shooting	○	○	○	○	○	○
	High-speed continuous shooting	○	○	○	○	○	○
	Low-speed continuous shooting	○	○	○	○	○	○
	Silent single shooting*1	○	○	○	○	○	○
	Silent continuous shooting*1	○	○	○	○	○	○
	10-sec. self-timer/Remote control	○	○	○	○	○	○
	2-sec. self-timer/Remote control	○	○	○	○	○	○
	Self-timer: Continuous	○	○	○	○	○	○
Metering	Evaluative metering	●	●		●	●	●
	Partial metering						
	Spot metering						
	Center-weighted average metering			●			
Exposure	Program shift						
	Exposure compensation						
	AEB						
	AE lock						
	Depth-of-field preview						
	HDR shooting						
	Multiple exposures						
	Interval timer*1	○	○	○	○	○	○
	Bulb timer						
	Mirror lockup						
External flash units	Flash on	●	●		●	●	
	Flash off			●			●
	Flash exposure compensation						
	FE lock*1						
	Flash function settings						
	Custom Function settings						
GPS function	○	○	○	○	○	○	
Live View shooting	○	○		○	○	○	
Quick Control	○	○	○	○	○	○	
Touch operation	○	○	○	○	○	○	

\*1: Settable only with viewfinder shooting (enabled).







\*2: Focusing is performed with the (single) AF point at the viewfinder center.

## Movie Shooting

● : Set automatically ○ : User selectable □ : Not selectable/Disabled

Function		(A+) / CA	SCN	P/Tv/Av/B	M
			 HDR		
<b>Movie recording quality selectable</b>		○	●*1	○	○
<b>Sound recording</b>	Auto	●	●	○	○
	Custom	□	□	○	○
	Wind filter	●	●	○	○
	Attenuator	□	□	○	○
<b>HDR movie</b>		□	●*2	□	□
<b>Time-lapse movie</b>	4K	○	□	○	○
	Full HD	○	□	○	○
<b>Video snapshot</b>		○	□	○	○
<b>ISO speed</b>	Automatically set/Auto	●	●	●	○
	Manually set	□	□	□	○
<b>Picture Style</b>	Auto	●	●	○	○
	Manual selection	□	□	○	○
<b>White balance</b>	Auto	●	●	○	○
	Preset	□	□	○	○
	Custom	□	□	○	○
	Color temperature setting	□	□	○	○
	Correction	□	□	○	○
<b>Auto Lighting Optimizer</b>		●	●	○	○
<b>High ISO speed noise reduction</b>		●	●	○	○
<b>Highlight tone priority</b>		□	□	○	○
<b>Lens aberration correction</b>	Peripheral illumination correction	●	□	○	○
	Chromatic aberration correction	●	●	○	○
<b>Movie digital IS</b>		○	□	○	○



Function		 / 	SCN	P/Tv/Av/B	M
					
AF	 +Tracking	○	○	○	○
	Smooth zone	○	○	○	○
	Live 1-point AF	○	○	○	○
	Manual focusing (MF)	○	○	○	○
	Movie servo AF	○	○	○	○
	• Tracking sensitivity			○	○
	• AF speed			○	○
Metering		●	●	●	●
Exposure	Program shift				
	Exposure compensation			○	○*3
	AE lock			○	○*4
GPS function		○	○	○	○
Remote control shooting		○	○	○	○
Quick Control		○	○	○	○
Touch operation		○	○	○	○

\*1: Automatically set to NTSC:   / PAL:  .

\*2: In the <SCN> mode, HDR movie shooting will be set automatically.

\*3: With ISO Auto, exposure compensation can be set.

\*4: With ISO Auto, a fixed ISO speed can be set.

## MENU Menu Settings

### Viewfinder Shooting (Basic Zone Modes)

#### 📷: Shooting 1 (Red)

Page

Image quality* <sup>1</sup>	RAW / M RAW / S RAW	162
	▲ L, ▲ L, ▲ M, ▲ M, ▲ S1, ▲ S1, S2	
Image review time	Off / 2 sec. / 4 sec. / 8 sec. / Hold	74
Release shutter without card	Enable / Disable	44
Interval timer	Disable / Enable (Interval / Number of shots)	267
Live View shooting	Enable / Disable	291

\*1: In the <📷> and <📷> modes, RAW quality cannot be selected.

### Live View Shooting (Basic Zone Modes)

#### 📷: Shooting 1 (Red)

Page

Image quality* <sup>1</sup>	RAW / M RAW / S RAW	162
	▲ L, ▲ L, ▲ M, ▲ M, ▲ S1, ▲ S1, S2	
Image review time	Off / 2 sec. / 4 sec. / 8 sec. / Hold	74
Release shutter without card	Enable / Disable	44

\*1: In the <📷> and <📷> modes, RAW quality cannot be selected.

#### 📷: Shooting 2 (Red)

Page

AF method* <sup>1</sup>	☺ +Tracking / Smooth zone / Live 1-point AF	308
Touch Shutter	Disable / Enable	319
Grid display	Off / 3x3 田 / 6x4 田田 / 3x3+diag 田田	302

\*1: Not settable in the <📷> mode. (Automatically set to [Smooth zone].)

## Viewfinder Shooting and Live View Shooting (Creative Zone Modes)

: Shooting 1\*<sup>1</sup> (Red)

Page

Image quality	RAW / M RAW / S RAW	162
	L,  L,  M,  M,  S1,  S1, S2	
Image review time* <sup>2</sup>	Off / 2 sec. / 4 sec. / 8 sec. / Hold	74
Release shutter without card* <sup>2</sup>	Enable / Disable	44
Lens aberration correction	Peripheral illumination correction: Enable / Disable	200
	Chromatic aberration correction: Enable / Disable	
	Distortion correction* <sup>2</sup> : Disable / Enable	
	Diffraction correction* <sup>2</sup> : Disable / Enable	
Lens electronic MF	Disable after One-Shot AF / Enable after One-Shot AF	155
External Speedlite control* <sup>2</sup>	Flash firing / E-TTL II metering / Flash sync. speed in Av mode / Flash function settings / Flash C.Fn settings / Clear settings	281

\*1: During movie shooting, [ 1: Movie rec. size] and [ 1: Sound recording] will be displayed (p.545).

\*2: Not displayed for movie shooting.

## 📷: Shooting 2 (Red)

Page

Exposure compensation/ AEB setting* <sup>1</sup>	Exposure compensation: ±5 stops* <sup>2</sup> in 1/3- or 1/2-stop increments	245
	AEB: ±3 stops in 1/3- or 1/2-stop increments	247
📷 ISO speed settings* <sup>3</sup>	ISO speed / ISO speed range / Auto range / Minimum shutter speed	170
		173
		174
		175
Auto Lighting Optimizer	Disable / Low / Standard / High	194
	Disabled in M or B modes	
White balance	<b>AWB</b> (Ambience priority) / <b>AWB w</b> (White priority) /  /  /  /  /  /  / <b>K</b> (Approx. 2500 - 10000)	185
Custom White Balance	Manual setting of white balance	188
White balance shift/ bracketing* <sup>4</sup>	White balance correction: B/A/M/G bias, 9 levels each	191
	White balance bracketing: B/A and M/G bias, single-level increments, ±3 levels	192
Color space* <sup>5</sup>	sRGB / Adobe RGB	208

\*1: For movie shooting, it will be [**📷2: Exposure compensation**].

\*2: During Live View shooting or movie shooting, exposure compensation can be set up to ±3 stops.

\*3: For movie shooting, it will be [**📷2: ISO speed settings**].









\*4: For movie shooting, it will be [**📷2: WB correction**].

\*5: Not displayed for movie shooting.

Shaded menu options are not displayed in Basic Zone modes.

 **Shooting 3 (Red)**

Page

<b>Picture Style</b>	 Auto /  Standard /  Portrait /  Landscape /  Fine Detail /  Neutral /  Faithful /  Monochrome /  User Defined 1-3	176
<b>Noise reduction for long exposures*<sup>1</sup></b>	Disable / Auto / Enable	197
<b>High ISO speed noise reduction</b>	Disable / Low / Standard / High / Multi Shot Noise Reduction* <sup>1</sup>	195
<b>Highlight tone priority</b>	Disable / Enable	199
<b>Dust Delete Data*<sup>1</sup></b>	Obtain data to be used with Digital Photo Professional (EOS software) to delete dust spots	452
<b>Multiple exposures*<sup>1</sup></b>	Multiple exposure / Multiple exposure control / Number of exposures / Continue multiple exposure / Select image for multiple exposures	258
<b>HDR mode*<sup>1</sup></b>	Adjust dynamic range / Effect / Continuous HDR / Auto Image Align	253

\*1: Not displayed for movie shooting.

**📷: Shooting 4 (Red)**

Page

<b>Interval timer</b> *1*2	Disable / Enable (Interval / Number of shots)	267
<b>Bulb timer</b>	Disable / Enable (Exposure time)	251
<b>Anti-flicker shooting</b> *1	Disable / Enable	206
<b>Mirror lockup</b> *1	Disable / Enable	265
<b>Aspect ratio</b>	3:2 / 4:3 / 16:9 / 1:1	168
<b>Live View shooting</b> *1*2	Enable / Disable	291

\*1: Not displayed for Live View shooting.

\*2: In Basic Zone modes, these menu options are displayed under the [📷1] tab.

**📷: Shooting5\*1\*2 (Red)**

Page

<b>AF method</b>	☺+Tracking / Smooth zone / Live 1-point AF	308
<b>Touch Shutter</b>	Disable / Enable	319
<b>Metering timer</b>	4 sec. / 8 sec. / 16 sec. / 30 sec. / 1 min. / 10 min. / 30 min.	302
<b>Grid display</b>	Off / 3x3 田 / 6x4 田田 / 3x3+diag 田田	302
<b>Exposure simulation</b>	Enable / During 📷 / Disable	303
<b>Silent LV shooting</b>	Mode 1 / Mode 2 / Disable	303

\*1: The [📷5] tab is displayed for Live View shooting. (Not displayed for viewfinder shooting.)

\*2: In Basic Zone modes, these menu options are displayed under the [📷2] tab.

## ▶: Playback 1 (Blue)

Page

<b>Protect images</b>	Protect images	409
<b>Rotate image</b>	Rotate images	408
<b>Erase images</b>	Erase images	430
<b>Print order</b>	Specify images to be printed (DPOF)	458
<b>Photobook set-up</b>	Specify images for a photobook	464
<b>RAW image processing</b>	Process <b>RAW</b> images	438



## ▶: Playback 2 (Blue)

Page

<b>Cropping</b>	Partially crop JPEG images	446
<b>Resizing</b>	Downsize JPEG image's pixel count	444
<b>Rating</b>	Rate images	412
<b>Slide show</b>	Display time / Repeat / Transition effect / Background music	424
<b>Set image search conditions</b>	Rating / Date / Folder / Protect / Type of file	402
<b>Image jump w/ </b>	1 image / 10 images / Jump images by the specified number / Date / Folder / Movies / Stills / Protect / Rating	400



## ▶: Playback 3 (Blue)

Page

<b>Highlight alert</b>	Disable / Enable	397
<b>AF point display</b>	Disable / Enable	397
<b>Playback grid</b>	Off / 3x3  / 6x4  / 3x3+diag 	390
<b>Histogram display</b>	Brightness / RGB	398
<b>Magnification (Approx.)</b>	1x (no magnification) / 2x (magnify from center) / 4x (magnify from center) / 8x (magnify from center) / 10x (magnify from center) / Actual size (from selected point) / Same as last magnification (from center)	405
<b>Control over HDMI</b>	Disable / Enable	428

## ☛: Set-up 1 (Yellow)

Page

<b>Select folder</b>	Create and select a folder	209
<b>File numbering</b>	Numbering: Continuous / Auto reset	211
	Manual reset	
<b>Vertical image auto rotation</b>	On   / On  / Off	435
<b>Format card</b>	Erase data on the card by formatting	70
<b>Eye-Fi settings</b>	Displayed when a commercially-available Eye-Fi card is inserted	522
<b>Wireless communication settings*<sup>1</sup></b>	Wi-Fi settings: Wi-Fi / NFC connection / Password / Connection history / MAC address	-
	Wi-Fi function: Transfer images between cameras / Connect to smartphone / Remote control (EOS Utility) / Print from Wi-Fi printer / Upload to Web service	
	Bluetooth function: Bluetooth function / Pairing / Check/clear connection info / Bluetooth address	
	Send images to smartphone	
	Nickname	
	Clear settings	

\*1: For details, refer to the “Wi-Fi (Wireless Communication) Function Instruction Manual” (p.4).



## ☛: Set-up 2 (Yellow)

Page

<b>Auto power off</b>	1 min. / 2 min. / 4 min. / 8 min. / 15 min. / 30 min. / Disable	73
<b>LCD brightness</b>	LCD brightness adjustable to 7 levels	434
<b>LCD off/on*<sup>1</sup></b>	Remains on / Shutter btn.	74
<b>Date/Time/Zone</b>	Date (year, month, day) / Time (hr., min., sec.) / Daylight saving time / Time zone	49
<b>Language</b> 	Select the interface language	52
<b>Viewfinder display*<sup>1</sup></b>	Electronic level: Hide / Show	81
	Grid display: Hide / Show	79
	Show/hide in viewfinder: Battery level, Shooting mode, AF operation, Image quality (Image type), Drive mode, Metering mode, Flicker detection	82

\*1: Not displayed for Live View shooting or movie shooting.

## ☛: Set-up 3 (Yellow)



Page

<b>GPS setting</b>	GPS / Auto time setting / Position update interval / GPS information display / GPS Logger	217
<b>Video system</b>	For NTSC / For PAL	341 427
<b>Mode guide*<sup>1</sup></b>	Enable / Disable	89
<b>Feature guide</b>	Enable / Disable	90
<b>Help text size</b>	Small / Standard	92

\*1: Not displayed for Live View shooting or movie shooting.

## ☝: Set-up 4 (Yellow): For viewfinder shooting

Page

<b>Touch operation</b>	Standard / Sensitive / Disable	69
<b>Beep</b>	Enable / Touch  / Disable	73
<b>Battery information</b>	Power source / Remaining capacity / Shutter count / Recharge performance	516
<b>Sensor cleaning</b>	Auto cleaning  : Enable / Disable	450
	Clean now 	
	Clean manually	455
<b>INFO button display options*1</b>	Electronic level / Quick Control screen	84
<b>Multi function lock</b>	Main Dial	88
	Quick Control Dial	
	Multi-controller	
	Touch operation	

\*1: For Live View shooting and movie shooting, it will be [INFO button LV display options].

## ☝: Set-up 4 (Yellow): For Live View shooting/Movie shooting

Page

<b>INFO button LV display options</b>	Live View info switch setting: 1 / 2 / 3 / 4	298
	Histogram display • Brightness/RGB: Brightness / RGB • Display size: Large / Small	299
	Reset	

## Y: Set-up 5 (Yellow)

Page

<b>Custom shooting modes (C1, C2)</b>	Register setting / Clear settings / Auto update settings	510
<b>Clear all camera settings</b>	Resets the camera to the default settings	75
<b>Copyright information</b>	Display copyright information / Enter author's name / Enter copyright details / Delete copyright information	214
<b>Manual/software URL</b>	URL and QR code for downloading Instruction Manuals and software	5
<b>Certification Logo Display</b>	Displays some of the logos of the camera's certifications	513
<b>Firmware*1</b>	Select to update the firmware of the camera, lens, Speedlite, etc.	–

\*1: Not displayed for Live View shooting or movie shooting.

 **Custom Functions (Orange)**

Page

<b>C.Fn I: Exposure</b>	Customize camera functions as desired	471
<b>C.Fn II: Autofocus</b>		475
<b>C.Fn III: Operation/ Others</b>		489
<b>Clear all Custom Functions (C.Fn)</b>	Clear Custom Function settings	468

 **My Menu (Green)**

Page

<b>Add My Menu tab</b>	Add My Menu tabs 1-5	505
<b>Delete all My Menu tabs</b>	Delete all My Menu tabs	508
<b>Delete all items</b>	Delete all items under My Menu tabs 1-5	508
<b>Menu display</b>	Normal display / Display from My Menu tab / Display only My Menu tab	509

## Movie Shooting

### Shooting 1 (Red)



Page

<b>Movie recording size</b>	1920x1080 / 1280x720	341
	NTSC: 59.94p / 29.97p / 23.98p PAL: 50.00p / 25.00p	
	Standard (IPB) / Light (IPB)	
<b>Sound recording</b>	Sound recording*1: Auto / Manual / Disable	346
	Sound-recording level	
	Wind filter: Auto / Disable	
	Attenuator: Disable / Enable	347

\*1: In Basic Zone modes, it will be **[Enable]** **[Disable]**.

### Shooting 2 (Red)

Page











<b> ISO speed settings</b>	ISO speed / ISO speed range / ISO Auto /  ISO Auto	372
---	--	-----



- The “Movie Shooting” table only includes what is not covered by the “Viewfinder Shooting and Live View Shooting” table.
- For [ Shooting 3] (Red), see page 537.

 **Shooting 4<sup>\*1</sup> (Red)**

Page

<b>Movie Servo AF</b>	Enable / Disable	373
<b>AF method</b>	 +Tracking / Smooth zone / Live 1-point AF	374
<b>Movie Servo AF tracking sensitivity</b>	Locked on (-3/-2/-1) / 0 / Responsive (+1/+2/+3)	375
<b>Movie Servo AF Speed</b>	When active: Always on / During shooting	376
	AF speed: Slow (-7/-6/-5/-4/-3/-2/-1) / Standard / Fast (+1/+2)	
<b>Metering timer</b>	4 sec. / 8 sec. / 16 sec. / 30 sec. / 1 min. / 10 min. / 30 min.	377
<b>Grid display</b>	Off / 3x3  / 6x4  / 3x3+diag 	377
<b> button function</b>	 AF / - /  / - /  AF /  /  / 	378

\*1: In Basic Zone modes, these menu options are displayed under the [2] tab.

 : Shooting 5\*<sup>1</sup> (Red)

Page

<b>Video snapshot</b>	Video snapshot: Enable / Disable	361
	Album settings: Create a new album / Add to existing album	
	Show confirm message: Enable / Disable	364
<b>Time-lapse movie</b>	Time-lapse movie: Disable / Enable 4K (3840x2160) / Enable FHD (1920x1080)	350
	Shooting interval (hr., min., sec.)	351
	Number of shots	
	Auto exposure: Fixed 1st frame / Each frame	352
	LCD auto off: Disable / Enable	
	Beep as image taken: Enable / Disable	353
<b>Movie digital IS</b>	Disable / Enable / Enhanced	380
<b>Remote control shooting</b>	Disable / Enable	381

\*1: In Basic Zone modes, these menu options are displayed under the [ 3] tab.

# Troubleshooting Guide

If a problem occurs with the camera, first consult this Troubleshooting Guide. If this Troubleshooting Guide does not resolve the problem, contact your dealer or nearest Canon Service Center.

## Power-Related Problems

### The battery does not recharge.

- If the battery's remaining capacity (p.516) is 94% or higher, the battery will not be recharged.
- Do not use any battery other than genuine Canon Battery Pack LP-E6N/LP-E6.

### The charger's lamp blinks at high speed.

- If (1) the battery charger or battery has a problem or (2) communication with the battery failed (with a non-Canon battery pack), the protection circuit will stop charging, and the charge lamp will blink in orange at a constant high speed. In the case of (1), unplug the charger's power plug from the power outlet. Detach and reattach the battery to the charger. Wait a few minutes, then reconnect the power plug to the power outlet. If the problem persists, contact your dealer or nearest Canon Service Center.

### The charger's lamp does not blink.

- If the internal temperature of the battery attached to the charger is high, the charger will not charge the battery for safety reasons (lamp off). During charging, if the battery's temperature becomes high for any reason, charging will stop automatically (lamp blinks). When the battery temperature goes down, charging will resume automatically.

### The camera is not activated on even when the power switch is set to <ON>.

- Make sure the battery compartment cover is closed (p.42).
- Make sure the battery is installed properly in the camera (p.42).
- Recharge the battery (p.40).
- Make sure the card slot cover is closed (p.43).



**The access lamp still lights or blinks even when the power switch is <OFF>.**

- If the power is turned off while an image is being recorded to the card, the access lamp will remain on or continue to blink for a few seconds. When the image recording is complete, the power will turn off automatically.

**[Does this battery/do these batteries display the Canon logo?] is displayed.**

- Do not use any battery other than genuine Canon Battery Pack LP-E6N/LP-E6.
- Remove and install the battery again (p.42).
- If the electrical contacts are dirty, use a soft cloth to clean them.

**The battery becomes exhausted quickly.**

- Use a fully-charged battery (p.40).
- The battery performance may have degraded. See [**4: Battery info.**] to check the battery's recharge performance level (p.516). If the battery performance is poor, replace the battery with a new one.
- The number of possible shots will decrease with any of the following operations:
  - Pressing the shutter button halfway for a prolonged period.
  - Activating the AF frequently without taking a picture.
  - Using the lens's Image Stabilizer.
  - Using GPS.
  - Using the LCD monitor frequently.
  - Continuing Live View shooting or movie shooting for a prolonged period.
  - Using the Wi-Fi/NFC/Bluetooth (wireless communication) function.
  - Enabling the Eye-Fi card's transmission.

### The camera turns off by itself.

- Auto power off is in effect. If you do not want auto power off to take effect, set [**⚡2: Auto power off**] to [**Disable**] (p.73).
- Even if [**⚡2: Auto power off**] is set to [**Disable**], the LCD monitor will still turn off after the camera is left idle for approx. 30 min. (The camera's power does not turn off.)

## Shooting-Related Problems

### The lens cannot be attached.

- The camera cannot be used with EF-S or EF-M lenses (p.53).

### The viewfinder is dark.

- Install a recharged battery in the camera (p.40).

### No images can be shot or recorded.

- Make sure the card is properly inserted (p.43).
- Slide the card's write-protect switch to the Write/Erase setting (p.43).
- If the card is full, replace the card or delete unnecessary images to make space (p.43, 430).
- You cannot take a picture when focusing with One-Shot AF and the focus indicator <●> in the viewfinder is blinking or when the AF point is orange during Live View/movie shooting. Press the shutter button halfway again to refocus automatically, or focus manually (p.56, 154).

**The card cannot be used.**

- If a card error message is displayed, see page 45 or 567.

**An error message is displayed when the card is inserted in another camera.**

- Since SDXC cards are formatted in exFAT, if you format a card with this camera and then insert it into another camera, an error may be displayed and it may not be possible to use the card.

**I have to press the shutter button twice to take a picture.**

- Set [ 4: Mirror lockup] to [Disable].



**The image is out of focus or blurred.**

- Set the lens's focus mode switch to <AF> (p.53).
- Press the shutter button gently to prevent camera shake (p.55, 56).
- With a lens equipped with an Image Stabilizer, set the IS switch to <ON>.
- In low light, the shutter speed may become slow. Use a faster shutter speed (p.236), set a higher ISO speed (p.170), use flash (p.278), or use a tripod.
- See "Minimizing Blurred Photos" on page 96.

### **There are fewer AF points or the Area AF frame shape is different.**

- Depending on the attached lens, the number of usable AF points and patterns and Area AF frame shape vary. The lenses are categorized into 8 groups from A to H (p.145). Check which group your lens belongs to. Using a lens in Groups E to H will have fewer usable AF points (p.147-148).

### **The AF point is blinking or two AF points are displayed.**

- Regarding the AF points lighting up or blinking when you press the  or  button, see page 138.

### **The AF points do not light up in red.**

- The AF points light up in red when you shoot under low light or when focus is achieved on a dark subject.
- In the **<P>**, **<Tv>**, **<Av>**, **<M>**, or **<B>** mode, you can set whether to have the AF points light up in red for when focus is achieved (p.488).

### **I cannot lock the focus and recompose the shot.**

- Set the AF operation to One-Shot AF. Focus lock is not possible in the AI Servo AF/Servo AF mode or when servo takes effect in AI Focus AF mode (p.97, 131).

**The continuous shooting speed is slow.**

- The continuous shooting speed for high-speed continuous shooting may decrease depending on the temperature, battery level, flicker reduction, shutter speed, aperture, subject conditions, brightness, AF operation, lens, Live View shooting, flash use, shooting function settings, etc. For details, see page 156 or 158.

**The maximum burst during continuous shooting is lower.**

- If you shoot a subject that has fine detail such as a field of grass, the file size will be larger, and the actual maximum burst may be lower than the number listed on page 164.

**Even after I change the card, the maximum burst displayed for continuous shooting does not change.**

- The maximum burst displayed in the viewfinder does not change when you change the card, even if it is a high-speed card. The maximum burst shown in the table on page 164 is based on Canon's testing card. (The faster the card's writing speed, the higher the actual maximum burst will be.) Therefore, the maximum burst displayed in the viewfinder may differ from the actual maximum burst.

### ISO 100 cannot be set. ISO speed expansion cannot be selected.

- If [**📷3: Highlight tone priority**] is set to [**Enable**], the settable ISO speed range will be ISO 200 - ISO 40000 (for still photo shooting). Even if you set [**ISO speed range**] to expand the setting range, you cannot select L (equivalent to ISO 50), H1 (equivalent to ISO 51200), or H2 (equivalent to ISO 102400). When [**📷3: Highlight tone priority**] is set to [**Disable**] (p.199), you can set ISO 100/125/160, L, or H1/H2.

### Even if I set a decreased exposure compensation, the image comes out bright.

- Set [**📷2: Auto Lighting Optimizer**] to [**Disable**] (p.194). When [**Low**], [**Standard**], or [**High**] is set, even if you set a decreased exposure compensation or flash exposure compensation, the image may come out bright.

### I cannot set the exposure compensation when both manual exposure and ISO Auto are set.

- See page 242 to set the exposure compensation.

### Not all the lens aberration correction options are displayed.

- During movie shooting, [**Distortion correction**] or [**Diffraction correction**] will not be displayed.

### When I use the <Av> mode with flash, the shutter speed becomes slow.

- If you shoot at night when the background is dark, the shutter speed automatically becomes slow (slow-sync shooting) so that both the subject and background are properly exposed. To prevent a slow shutter speed, under [**1: External Speedlite control**], set [**Flash sync. speed in Av mode**] to [**1/180-1/60sec. auto**] or [**1/180 sec. (fixed)**] (p.282).

### The flash does not fire.

- Make sure the flash is securely attached to the camera.
- If you use a non-Canon flash unit with Live View shooting, set [**5: Silent LV shoot.**] to [**Disable**] (p.303).

### The flash always fires at full output.

- If you use a flash unit other than an EX-series Speedlite, the flash will always fire at full output (p.279).
- When the flash Custom Function setting for [**Flash metering mode**] is set to [**TTL flash metering**] (autoflash), the flash will always fire at full output (p.286).



### Flash exposure compensation cannot be set.

- If flash exposure compensation is already set with the Speedlite, flash exposure compensation cannot be set with the camera. When the external Speedlite's flash exposure compensation is canceled (set to 0), flash exposure compensation can be set with the camera.

### High-speed sync cannot be set in the <Av> mode.

- Under [**1: External Speedlite control**], set [**Flash sync. speed in Av mode**] to [**Auto**] (p.282).

### Remote control shooting is not possible.

- When taking still photos, set the drive mode to <img alt="i icon" data-bbox="198 148 212 162"/> <img alt="i2 icon" data-bbox="218 148 232 162"/> or <img alt="i icon" data-bbox="198 168 212 182"/> <img alt="i2 icon" data-bbox="218 168 232 182"/> (p.157). When shooting movies, set [ 5: Remote control] to [Enable] (p.381).
- Check the position of the remote controller's release timing switch.
- If you are using Wireless Remote Control BR-E1, see page 273.
- Under [ 1: Wireless communication settings], if [Bluetooth function] is set to [Smartphone] or [Remote], you cannot use infrared remote controllers such as the RC-6 for remote control shooting. Set [Bluetooth function] to [Disable].
- To use a remote controller for time-lapse movie shooting, see page 360.

### The shutter makes two release sounds during Live View shooting.

- If you use flash with Live View shooting, the shutter will make two release sounds each time you shoot (p.292).

### During Live View shooting, a white or red icon is displayed.

- It indicates that the camera's internal temperature is high. If the white <img alt="temp icon" data-bbox="408 654 422 668"/> icon is displayed, the still photo's image quality may deteriorate. If the red <img alt="temp icon" data-bbox="408 678 422 692"/> icon is displayed, it indicates that the Live View shooting will soon stop automatically (p.323).



### Shot images are not displayed when continuous shooting is performed during Live View shooting.

- If the image-recording quality is set to **M RAW** or **S RAW**, the shot images are not displayed during continuous shooting (p.291).

### During movie shooting, the red icon is displayed.

- It indicates that the camera's internal temperature is high. If the red  icon is displayed, it indicates that the movie shooting will soon stop automatically (p.382).



### Movie shooting stops by itself.

- If the card's writing speed is slow, movie shooting may stop automatically. For cards that can record movies, see page 343. To find out the card's writing speed, refer to the card manufacturer's Web site, etc.
- If you shoot a movie for 29 min. 59 sec., the movie shooting will stop automatically.

### The ISO speed cannot be set for movie shooting.

- In shooting modes other than **<M>**, the ISO speed is set automatically. In the **<M>** mode, you can manually set the ISO speed (p.331).

### ISO 100 cannot be set or ISO speed expansion cannot be selected during movie shooting.

- If [ **3: Highlight tone priority**] is set to **[Enable]**, the settable ISO speed range will start from ISO 200. Even if you expand the setting range with **[ISO speed range]**, you cannot select H1 or H2. When [ **3: Highlight tone priority**] is set to **[Disable]** (p.199), you can set ISO 100/125/160 or an expanded ISO speed.

### The manually set ISO speed changes when switching to movie shooting.

- For viewfinder shooting and Live View shooting, the ISO speed will be set according to [ISO speed range] under [2: ISO speed settings] (p.173). For movie shooting, the ISO speed will be set according to [ISO speed range] under [2: ISO speed settings] (p.372).

### The exposure changes during movie shooting.

- If you change the shutter speed or aperture during movie shooting, the changes in the exposure may be recorded.
- Shooting a few test movies is recommended if you intend to perform zooming during movie shooting. Zooming during movie shooting may result in recording of changes in exposure or mechanical sound of the lens, or images may be out of focus.

### The image flickers or horizontal stripes appear during movie shooting.

- Flickering, horizontal stripes (noise), or irregular exposures can be caused by fluorescent lighting, LED lighting, or other light sources during movie shooting. Also, changes in the exposure (brightness) or color tone may be recorded. In the <M> mode, a slow shutter speed may reduce the problem. The problem may be more noticeable in time-lapse movie shooting.

**The subject looks distorted during movie shooting.**

- If you move the camera to the left or right (panning) or shoot a moving subject, the image may look distorted. The problem may be more noticeable in time-lapse movie shooting.

**I cannot take still photos during movie shooting.**

- Still photos cannot be taken during movie shooting. To take still photos, stop the movie shooting and perform viewfinder shooting or Live View shooting.

**Wi-Fi****Wi-Fi function cannot be set.**

- If the camera is connected to a computer or other device with an interface cable (sold separately), Wi-Fi functions cannot be set. Disconnect the interface cable before setting any functions. For details, refer to the “Wi-Fi (Wireless Communication) Function Instruction Manual” (p.4).

## Operation Problems

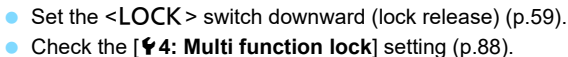

I cannot change the setting with the <

- Set the <LOCK> switch downward (lock release) (p.59).
- Check the [4: Multi function lock] setting (p.88).

Touch operation is not possible.

- Make sure [4: Touch control] is set to [Standard] or [Sensitive] (p.69).

A camera button or dial does not work as expected.

- For movie shooting, check the [4:  btn function] setting (p.378).
- Check the [C.Fn III-4: Custom Controls] setting (p.497).

## Display Problems

The menu screen shows fewer tabs and options.

- Certain tabs and options do not appear in Basic Zone modes or for Live View shooting and movie shooting.

The display starts with [] My Menu or the [] tab alone is displayed.

- Under the [] tab, [Menu display] is set to [Display from My Menu tab] or [Display only My Menu tab]. Set [Normal display] (p.509).

**The file name's first character is an underscore (“\_”).**

- Set [📷2: Color space] to [sRGB]. If [Adobe RGB] is set, the first character will be an underscore (p.208).

**The file name starts with “MVI\_”.**

- It is a movie file (p.211).

**The file numbering does not start from 0001.**

- If the card already contains recorded images, the image number may not start from 0001 (p.211).

**The shooting date and time displayed are incorrect.**

- Make sure the correct date and time are set (p.49).
- Check the time zone and daylight saving time (p.50, 51).

**The date and time are not in the image.**

- The shooting date and time do not appear in the image. The date and time are recorded in the image data as shooting information. When printing, you can imprint the date and time in the picture, using the date and time recorded in the shooting information (p.458).

### **[###] is displayed.**

- If the number of images recorded on the card exceeds the number the camera can display, [###] will be displayed.

### **In the viewfinder, the AF point display speed is slow.**

- In low temperatures, the display speed of the AF points may become slower due to the AF point display device's (liquid crystal) characteristics. The display speed will return to normal at room temperature.

### **The LCD monitor does not display a clear image.**

- If the LCD monitor is dirty, use a soft cloth to clean it.
- The LCD monitor display may seem slightly slow in low temperatures or may look black in high temperatures. It will return to normal at room temperature.

### **[Eye-Fi settings] does not appear.**

- [**🔧1: Eye-Fi settings**] will appear only when an Eye-Fi card is installed in the camera. If the Eye-Fi card has a write-protect switch set to the LOCK position, you will not be able to check the card's connection status or disable Eye-Fi transmission (p.522).
- Image transfer with Eye-Fi card is not possible if [**Enable**] is set for [**Wi-Fi**] in [**Wi-Fi Settings**] under [**🔧1:Wireless Communication settings**].

## Playback Problems



### Part of the image blinks in black.

- [▶3: Highlight alert] is set to [Enable] (p.397).

### A red box is displayed on the image.

- [▶3: AF point disp.] is set to [Enable] (p.397).

### During image playback, the AF points are not displayed.

- The AF points are not displayed when the following types of images are played back:
  - Images taken in the <SCN:    > modes.
  - Images taken with distortion correction applied.
  - Images taken with Multi Shot Noise Reduction applied.
  - Cropped images.

### The image cannot be erased.

- If the image is protected, it cannot be erased (p.409).

### Still photos and movies cannot be played back.

- The camera may not be able to play back images taken with another camera.
- Movies edited with a computer cannot be played back with the camera.

### Only few images can be played back.

- The images have been filtered for playback with [▶2: Set image search conditions] (p.402). Clear the image search conditions.

### Operation sound and mechanical sound can be heard during movie playback.

- If you operate the camera's dials or lens during movie shooting, the operation sound will also be recorded. Using the Directional Stereo Microphone DM-E1 (sold separately) is recommended (p.347).

### The movie appears to freeze momentarily.

- If there is a drastic change in the exposure level during autoexposure movie shooting, the recording will stop momentarily until the brightness stabilizes. In such a case, shoot in the <M> mode (p.330).

### No picture appear on the TV set.

- Make sure the [**3: Video system**] is correctly set to [**For NTSC**] or [**For PAL**] (depending on the video system of your TV set).
- Make sure the HDMI cable's plug is inserted all the way in (p.427).

### There are multiple movie files for a single movie shoot.

- If the movie file size reaches 4 GB, another movie file will be created automatically (p.345). However, if you use an SDXC card formatted with the camera, you can record a movie in a single file even if it exceeds 4 GB.



**My card reader does not recognize the card.**

- Depending on the card reader used and the computer's operating system, SDXC cards may not be correctly recognized. In such a case, connect your camera to the computer with the interface cable (sold separately), then transfer the images to the computer using EOS Utility (EOS software, p.594).

**I cannot process the RAW image.**

- **M RAW** and **S RAW** images cannot be processed with the camera. Use Digital Photo Professional (EOS software, p.594) to process those images.

**The image cannot be resized.**

- With this camera, you cannot resize JPEG **S2** and **RAW** images (p.444).

**The image cannot be cropped.**

- With this camera, you cannot crop RAW images (p.446).

**Dots of light appear on the image.**

- White, red, blue, or other colored dots of light may appear on images if the sensor is affected by cosmic rays, etc. Their appearance may be reduced by performing [**Clean now** ] under [**4: Sensor cleaning**] (p.450).

## Sensor Cleaning Problems

### The shutter makes a sound during sensor cleaning.

- Under [**4: Sensor cleaning**], when you select [**Clean now** ], the shutter will make a mechanical sound during the cleaning, but no picture will be recorded to the card (p.450).

### Automatic sensor cleaning does not work.

- If you repeatedly turn the power switch <ON> and <OFF> within a short time period, the < > icon may not be displayed (p.47).

## Computer Connection Problems

### I cannot transfer images to a computer.

- Install EOS Utility (EOS software) in the computer (p.596).
- If the camera is already connected via Wi-Fi, it cannot communicate with any computer connected with an interface cable (sold separately).

### Communication between the connected camera and computer does not work.

- When using EOS Utility (EOS software), set [**5: Time-lapse movie**] to [**Disable**] (p.350).

# Error Codes

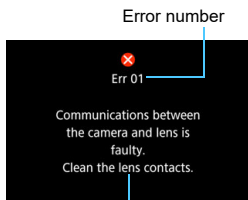

Cause and countermeasures

If there is a problem with the camera, an error message will appear. Follow the on-screen instructions.

Number	Error Message and Solution
01	<b>Communications between the camera and lens is faulty. Clean the lens contacts.</b>
	→ Clean the electrical contacts on the camera and lens, use a genuine Canon lens, or remove and install the battery again (p.27, 28, 42).
02	<b>Card cannot be accessed. Reinsert/change card or format card with the camera.</b>
	→ Remove and insert the card again, replace the card, or format the card (p.43, 70).
04	<b>Cannot save images because card is full. Replace card.</b>
	→ Replace the card, erase unnecessary images, or format the card (p.43, 430, 70).
06	<b>Sensor cleaning could not be performed. Turn the camera off and on again.</b>
	→ Operate the power switch (p.47).
10, 20 30, 40 50, 60 70, 80 99	<b>An error prevented shooting. Turn the camera off and on again or re-install the battery.</b>
	→ Operate the power switch, remove and install the battery again, or use a Canon lens (p.47, 42).

\* If the error message still persists after following the above instructions, write down the error code number and contact your nearest Canon Service Center.

# Specifications

## • Type

Type:	Digital, single-lens reflex, AF/AE camera
Recording media:	SD/SDHC*/SDXC* memory cards * UHS-I cards compatible.
Image sensor size:	Approx. 35.9 x 24.0 mm
Compatible lenses:	Canon EF lenses * Excluding EF-S and EF-M lenses (The effective angle of view of a lens is approximately equivalent to that of the focal length indicated.)
Lens mount:	Canon EF mount

## • Image Sensor

Type:	CMOS sensor
Effective pixels:	Approx. 26.2 megapixels * Rounded to the nearest 100,000.
Aspect ratio:	3:2
Dust deletion:	Auto/Manual, Appending Dust Delete Data

## • Recording System

Recording format:	Design rule for Camera File System (DCF) 2.0
Image type:	JPEG, RAW (14-bit Canon original), RAW+JPEG simultaneous recording possible
Pixels recorded:	L (Large) : Approx. 26.0 megapixels (6240 x 4160) M (Medium) : Approx. 11.5 megapixels (4160 x 2768) S1 (Small 1) : Approx. 6.5 megapixels (3120 x 2080) S2 (Small 2) : Approx. 3.8 megapixels (2400 x 1600) RAW : Approx. 26.0 megapixels (6240 x 4160) M-RAW : Approx. 14.6 megapixels (4680 x 3120) S-RAW : Approx. 6.5 megapixels (3120 x 2080) * Rounded to the nearest 100,000.
Aspect ratio:	3:2, 4:3, 16:9, 1:1
Folder creation and selection:	Possible
File numbering:	Continuous, Auto reset, Manual reset

## • Image Processing During Shooting

Picture Style:	Auto, Standard, Portrait, Landscape, Fine Detail, Neutral, Faithful, Monochrome, User Defined 1 - 3
White balance:	Auto (Ambience priority), Auto (White priority), Preset (Daylight, Shade, Cloudy, Tungsten light, White fluorescent light, Flash), Custom, Color temperature setting (approx. 2500-10000 K) White balance correction and white balance bracketing features provided * Flash color temperature information transmission possible
Automatic image brightness correction:	Auto Lighting Optimizer provided
Noise reduction:	Applicable to high ISO speed shots and long exposures
Highlight tone priority:	Provided
Lens aberration correction:	Peripheral illumination correction, Chromatic aberration correction, Distortion correction, Diffraction correction

## • Viewfinder

Type:	Eye-level pentaprism
Field of view coverage:	Vertical/Horizontal approx. 98% (with eyepoint approx. 21 mm and aspect ratio set to 3:2)
Magnification:	Approx. 0.71x (-1 m <sup>-1</sup> with 50mm lens at infinity)
Eyepoint:	Approx. 21 mm (from eyepiece lens center at -1 m <sup>-1</sup> )
Dioptic adjustment range:	Approx. -3.0 - +1.0 m <sup>-1</sup> (dpt)
Focusing screen:	Fixed, Precision Matte
Grid display:	Provided
Electronic level:	Provided
Function setting display:	Battery level (remaining capacity), Shooting mode, AF operation, Image quality (Image type), Drive mode, Metering mode, Flicker detection, Warning! display
Mirror:	Quick-return type
Depth-of-field preview:	Provided

## • **Autofocus** (during viewfinder shooting)

Type:	TTL secondary image-registration, phase-difference detection with the dedicated AF sensor
AF points:	Max. 45 points (Cross-type AF point: Max. 45 points) * Number of available AF points, Dual cross-type AF points, and Cross-type AF points vary depending on the lens used. * Dual cross-type focusing at f/2.8 with center AF point when Group A (of the AF groups) lenses are used.
Focusing brightness range:	EV -3 - 18 (with the center AF point supporting f/2.8, One-Shot AF, room temperature, ISO 100)
Focus operation:	One-Shot AF, AI Servo AF, AI Focus AF, Manual focusing (MF)
AF area selection mode:	Single-point Spot AF (manual selection), Single-point AF (manual selection), Zone AF (manual selection of zone), Large zone AF (manual selection of zone), Automatic selection AF
AF point automatic selection conditions:	Automatic AF point selection possible based on color information equivalent to human skin-tone
AI Servo AF characteristics:	Characteristics can be set with Custom Functions for Tracking sensitivity, Acceleration/deceleration tracking, and AF point auto switching
AF fine adjustment:	AF Microadjustment (All lenses by the same amount, Adjust by lens)
AF-assist beam:	With the EOS-dedicated external Speedlite

## • **Exposure Control**

Metering mode:	Approx. 7,560-pixel RGB+IR metering sensor and 63-zone TTL open-aperture metering • Evaluative metering (linked to all AF points) • Partial metering (approx. 6.5% of viewfinder at center) • Spot metering (approx. 3.2% of viewfinder at center) • Center-weighted average metering
Metering brightness range:	EV 1 - 20 (at room temperature, ISO 100)

Shooting mode:	<p>Basic Zone modes:          Scene Intelligent Auto, Creative Auto, Special Scene (Portrait, Group Photo, Landscape, Sports, Kids, Panning, Close-up, Food, Candlelight, Night Portrait, Handheld Night Scene, HDR Backlight Control)</p> <p>Creative Zone modes:          Program AE, Shutter-priority AE, Aperture-priority AE, Manual exposure, Bulb exposure, Custom shooting modes (C1/C2)</p>
ISO speed (Recommended exposure index):	<p>Basic Zone modes: ISO speed set automatically          P, Tv, Av, M, B: ISO Auto, ISO 100 - ISO 40000 manual setting (in 1/3- or whole-stop increments), and expansion to L (equivalent to ISO 50), H1 (equivalent to ISO 51200), H2 (equivalent to ISO 102400) provided.          * With highlight tone priority set, the minimum limit will be ISO 200.</p>
ISO speed settings:	ISO speed range, Auto range, and minimum speed limit for Auto settable
Exposure compensation:	<p>Manual:          With viewfinder shooting: <math>\pm 5</math> stops in 1/3- or 1/2-stop increments          With Live View shooting: <math>\pm 3</math> stops in 1/3- or 1/2-stop increments</p> <p>AEB (Auto Exposure Bracketing):  <math>\pm 3</math> stops in 1/3- or 1/2-stop increments (can be combined with manual exposure compensation)</p>
AE lock:	<p>Auto: AE lock when focus is achieved can be enabled or disabled for each metering mode with a Custom Function</p> <p>Manual: With AE lock button</p>
Flicker reduction:	Provided
Interval timer:	Shooting interval and shot count settable
Bulb timer:	Bulb exposure time settable
Mirror lockup:	Provided

## • HDR Shooting

Dynamic range adjustment: Auto,  $\pm 1$ ,  $\pm 2$ ,  $\pm 3$

Effects: Natural, Art standard, Art vivid, Art bold, Art embossed

Auto image alignment: Provided

## • Multiple Exposures

Number of multiple exposures: 2 to 9 exposures

Multiple-exposure control: Additive, average

## • Shutter

Type: Electronically-controlled, focal-plane shutter  
Shutter speed: 1/4000 sec. to 30 sec. (total shutter speed range; available range varies by shooting mode), Bulb, X-sync at 1/180 sec.

## • Drive System

Drive mode: Single shooting, High-speed continuous shooting, Low-speed continuous shooting, Silent single shooting, Silent continuous shooting, 10-sec. self-timer/remote control, 2-sec. self-timer/remote control, Self-timer: Continuous  
Continuous shooting speed: High-speed continuous shooting: Max. approx. 6.5 shots/sec.

- \* The continuous shooting speed decreases during Antiflicker shooting, during Live View shooting with Servo AF, or during Live View shooting with an external Speedlite.
  - \* The continuous shooting speed for high-speed continuous shooting may decrease depending on the temperature, battery level, flicker reduction, shutter speed, aperture, subject conditions, brightness, AF operation, lens, flash use, shooting function settings, etc.
- Low-speed continuous shooting: Max. approx. 3.0 shots/sec.
- \* The continuous shooting speed decreases during Live View shooting with an external Speedlite.
  - \* During Panning mode in viewfinder shooting: Max. approx. 4.3 shots/sec., in Live View shooting: Max. approx. 2.7 shots/sec. (at 1/30 sec. shutter speed, with maximum aperture)

Max. burst: Silent continuous shooting: Max. approx. 3.0 shots/sec.  
JPEG Large/Fine: Approx. 110 shots (Approx. 150 shots)  
RAW: Approx. 18 shots (Approx. 21 shots)  
RAW+JPEG Large/Fine: Approx. 17 shots (Approx. 19 shots)



- \* Based on Canon's standard testing SD card (Standard: 8 GB, High-speed: 16 GB, UHS-I compatible) and standard testing conditions (High-speed continuous shooting, ISO 100, Standard Picture Style).
- \* Figures in parentheses are the number of shots when a Canon's standard testing UHS-I SD card is used.

### • External Speedlite

Compatible Speedlites:	EX-series Speedlites
Flash metering:	E-TTL II autoflash
Flash exposure compensation:	±3 stops in 1/3- or 1/2-stop increments
FE lock:	Provided
PC terminal:	Not provided
Flash control:	Flash function settings, Flash Custom Function settings

### • Live View Shooting

Focus method:	Dual pixel CMOS AF
AF operation:	One-Shot AF, Servo AF
AF method:	Face+Tracking, Smooth zone, Live 1-point AF Manual focusing (approx. 5x and 10x magnification available for focus check)
Focusing brightness range:	EV -2.5 - 18 (at room temperature, ISO 100, One-Shot AF)
Metering mode:	Evaluative metering (315 zones), Partial metering (approx. 6.3% of Live View screen), Spot metering (approx. 2.7% of Live View screen), Center-weighted average metering
Metering brightness range:	EV 0 - 20 (at room temperature, ISO 100)
Silent Live View shooting:	Provided (Mode 1 and 2)
Touch Shutter:	Provided
Grid display:	3 types

## • Movie Shooting

Recording format:	MP4 * For time-lapse movies: MOV format
Movie:	MPEG-4 AVC/H.264 Variable (Average) bit rate * For 4K time-lapse movies: Motion JPEG
Audio:	AAC
Movie recording size:	Full HD (1920x1080), HD (1280x720) * For time-lapse movies: 4K (3840x2160) and Full HD selectable
Frame rate:	59.94p/29.97p/23.98p (with NTSC) 50.00p/25.00p (with PAL)
Compression method:	Standard (IPB), Light (IPB) * For 4K time-lapse movies: Motion JPEG / Full HD time-lapse movies: ALL-I (For editing/I-only)
Bit rate:	[MP4] Full HD (59.94p/50.00p)/Standard (IPB) : Approx. 60 Mbps Full HD (29.97p/25.00p/23.98p)/Standard (IPB) : Approx. 30 Mbps Full HD (29.97p/25.00p)/Light (IPB) : Approx. 12 Mbps HD (59.94p/50.00p)/Standard (IPB) : Approx. 26 Mbps HD (29.97p/25.00p)/Light (IPB) : Approx. 4 Mbps [MOV] 4K time-lapse movies (29.97p/25.00p) : Approx. 500 Mbps Full HD time-lapse movies (29.97p/25.00p) : Approx. 90 Mbps
Card performance requirements:	[Movie] (Writing/reading speed) Full HD (59.94p/50.00p)/Standard (IPB) : SD Speed Class 10 or faster Full HD (29.97p/25.00p/23.98p)/Standard (IPB) : SD Speed Class 6 or faster Full HD (29.97p/25.00p)/Light (IPB) : SD Speed Class 4 or faster HD (59.94p/50.00p)/Standard (IPB) : SD Speed Class 6 or faster HD (29.97p/25.00p)/Light (IPB) : SD Speed Class 4 or faster

	[Time-lapse movie] (Reading speed)
	4K Time-lapse movie (29.97p/25.00p) : UHS-I 90 MB/sec. or faster
	Full HD Time-lapse movie (29.97p/25.00p) : UHS-I Speed Class 3 or faster
Focus method:	Dual pixel CMOS AF
AF method:	Face+Tracking, Smooth zone, Live 1-point AF Manual focusing (approx. 5x and 10x magnification available for focus check)
Movie servo AF:	Possible * With movie Servo AF, the subject tracking and AF speed are settable.
Movie digital IS:	Possible (Enable/Enhanced)
Focusing brightness range:	EV -2.5 - 18 (at room temperature, ISO 100, One-Shot AF, 29.97 fps)
Metering mode:	Center-weighted average and Evaluative metering with the image sensor * Automatically set by the focus method
Metering brightness range:	EV 0 - 20 (at room temperature, ISO 100, center-weighted average metering)
Exposure control:	Auto exposure shooting (Program AE for movie shooting), manual exposure ±3 stops in 1/3- or 1/2-stop increments
Exposure compensation:	
ISO speed (Recommended exposure index):	Scene Intelligent Auto, Creative Auto: Automatically set within ISO 100 - ISO 25600 P/Tv/Av/B: Automatically set within ISO 100 - ISO 25600, maximum limit settable within ISO 6400 - H2 (equivalent to ISO 102400). M: ISO Auto (automatically set within ISO 100 - ISO 25600), Manual setting within ISO 100 - ISO 25600 (in 1/3- or whole-stop increments), expandable to H (equivalent to ISO 32000/40000), H1 (equivalent to ISO 51200), and H2 (equivalent to ISO 102400) * With highlight tone priority set, the minimum limit will be ISO 200. * The settable range is different for time-lapse movie shooting.

ISO speed settings:	For movie shooting, you can set the ISO speed range, maximum limit for ISO Auto, and maximum limit for time-lapse movie shooting with ISO Auto
Sound recording:	Built-in stereo microphones, external stereo microphone jack provided Sound-recording level adjustable, wind filter provided, attenuator provided
Grid display:	3 types
HDR movie shooting:	Automatically set in SCN modes
Time-lapse movie:	Movie recording quality (4K, Full HD), Shooting interval (hr., min., sec.), Number of shots, Auto exposure (Fixed 1st frame, Each frame), LCD auto off, and Beep at the time of shooting are settable.
Video snapshot:	Provided (2 sec., 4 sec., 8 sec.)
Remote control shooting:	Provided
Still photo shooting:	Not possible during movie shooting

### • LCD Monitor

Type:	TFT color, liquid-crystal monitor
Monitor size and dots:	Wide 3.0-in. (3:2) with approx. 1.04 million dots
Brightness adjustment:	Manual (7 levels)
Electronic level:	Provided
Interface languages:	25
Touch screen:	Capacitive sensing
Shooting mode guide:	Display on/off settable
Feature guide:	Display on/off settable
Help display:	Provided

\* Text size settable for Help screen

### • Playback

Image display format:	Single-image display (without shooting information), Single-image display (with basic information), Single-image display (Shooting information displayed: Detailed information, Lens/histogram, White balance, Picture Style 1, Picture Style 2, Color space/noise reduction, Lens aberration correction, GPS information), Index display (4/9/36/100 images)
-----------------------	---

Highlight alert:	Overexposed highlights blink
AF point display:	Provided (may not be displayed depending on shooting conditions)
Grid display:	3 types
Magnified view:	Approx. 1.5x-10x, initial magnification and position settable
Image search:	Search conditions settable (by rating, date, folder, protected, file type)
Image browsing method:	1 image, 10 images, Specified number, Date, Folder, Movies, Stills, Protect, Rating
Image rotation:	Provided
Image protection:	Provided
Rating:	Provided
Movie playback:	Possible (on LCD monitor or with HDMI)
Start/end movie scene editing:	Provided
Slide show:	All images or images matching the search conditions are played back automatically.

### • Post-Processing of Images

In-camera RAW image processing:	Brightness adjustment, White balance, Picture Style, Auto Lighting Optimizer, High ISO speed noise reduction, JPEG image-recording quality, Color space, Lens aberration correction (Peripheral illumination correction, Distortion correction, Chromatic aberration correction, Diffraction correction)
Resize:	Provided
Cropping:	Provided

### • Print Ordering

DPOF:	Version 1.1 compliant
-------	-----------------------

### • GPS Functions

Compatible satellites:	GPS satellites (USA), GLONASS satellites (Russia), Quasi-Zenith Satellite System (QZSS) MICHIBIKI (Japan)
GPS signal reception modes:	Mode 1, Mode 2

## Specifications

Geotag information appended to image:	Latitude, Longitude, Elevation, Coordinated Universal Time (UTC), Satellite signal acquisition status
Position update interval:	1 sec., 5 sec., 10 sec., 15 sec., 30 sec., 1 min., 2 min., 5 min.
Time setting:	GPS time data set to camera
Log data:	One file per day, NMEA format * Change in time zone creates another file. * The log data saved in internal memory can be transferred to a card or downloaded to a computer as a log file.
Log data deletion:	Possible

### • Customization Features

Custom Functions:	28 functions
Custom shooting modes:	Register under C1/C2 mode
My Menu:	Up to 5 screens can be registered
Copyright information:	Text entry and appending possible

### • Interface

DIGITAL terminal:	Hi-Speed USB equivalent Computer communication, Connect Station CS100 connection
HDMI mini OUT terminal:	Type C (Auto switching of resolution), CEC-compatible
External microphone IN terminal:	3.5 mm diameter stereo mini-jack Directional Stereo Microphone DM-E1 or commercially-available external microphone connectable
Remote control terminal:	For N3-type remote control units
Wireless remote control:	Compatible with Remote Controller RC-6 and Wireless Remote Control BR-E1 (via Bluetooth)
Eye-Fi card:	Supported

## • Power

Battery:	Battery Pack LP-E6N/LP-E6, quantity 1 * AC power usable with household power outlet accessories.
Battery information:	Power source, Battery level, Shutter count, Recharge performance, Battery registration possible
Number of possible shots:	With viewfinder shooting: Approx. 1200 shots at room temperature (23°C/73°F), approx. 1100 shots at low temperatures (0°C/32°F) With Live View shooting: Approx. 380 shots at room temperature (23°C/73°F), approx. 340 shots at low temperatures (0°C/32°F) * With a fully-charged Battery Pack LP-E6N.
Movie shooting time:	Total approx. 2 hr. 40 min. at room temperature (23°C/73°F) Total approx. 2 hr. 20 min. at low temperatures (0°C/32°F) * With a fully-charged Battery Pack LP-E6N, Movie Servo AF disabled, and Full HD 29.97p/25.00p/23.98p Standard (IPB) set.

## • Dimensions and Weight

Dimensions (W x H x D):	Approx. 144.0 x 110.5 x 74.8 mm / 5.67 x 4.35 x 2.94 in.
Weight:	Approx. 765 g / 26.98 oz. (including battery pack and card)/Approx. 685 g / 24.16 oz. (body only)

## • Operation Environment

Working temperature range:	0°C - +40°C/ 32°F - 104°F
Working humidity:	85% or less

- All the data above is based on Canon's testing standards and CIPA (Camera & Imaging Products Association) testing standards and guidelines.
- Dimensions and weight listed above are based on CIPA Guidelines (except weight for camera body only).
- Product specifications and the exterior are subject to change without notice.
- If a problem occurs with a non-Canon lens attached to the camera, consult the respective lens manufacturer.

## Trademarks

- Adobe is a trademark of Adobe Systems Incorporated.
- Microsoft and Windows are trademarks or registered trademarks of Microsoft Corporation in the United States and/or other countries.
- App Store and macOS are trademarks of Apple Inc., registered in the U.S. and other countries.
- SDXC logo is a trademark of SD-3C, LLC.
- HDMI, HDMI logo, and High-Definition Multimedia Interface are trademarks or registered trademarks of HDMI Licensing LLC.
- The Bluetooth<sup>®</sup> word mark and logos are registered trademarks owned by Bluetooth SIG, Inc. and any use of such marks by Canon Inc. is under license. Other trademarks and trade names are those of their respective owners.
- All other trademarks are the property of their respective owners.

## About MPEG-4 Licensing

“This product is licensed under AT&T patents for the MPEG-4 standard and may be used for encoding MPEG-4 compliant video and/or decoding MPEG-4 compliant video that was encoded only (1) for a personal and non-commercial purpose or (2) by a video provider licensed under the AT&T patents to provide MPEG-4 compliant video. No license is granted or implied for any other use for MPEG-4 standard.”

THIS PRODUCT IS LICENSED UNDER THE AVC PATENT PORTFOLIO LICENSE FOR THE PERSONAL USE OF A CONSUMER OR OTHER USES IN WHICH IT DOES NOT RECEIVE REMUNERATION TO (i) ENCODE VIDEO IN COMPLIANCE WITH THE AVC STANDARD ("AVC VIDEO") AND/OR (ii) DECODE AVC VIDEO THAT WAS ENCODED BY A CONSUMER ENGAGED IN A PERSONAL ACTIVITY AND/OR WAS OBTAINED FROM A VIDEO PROVIDER LICENSED TO PROVIDE AVC VIDEO. NO LICENSE IS GRANTED OR SHALL BE IMPLIED FOR ANY OTHER USE. ADDITIONAL INFORMATION MAY BE OBTAINED FROM MPEG LA, L.L.C. SEE [HTTP://WWW.MPEGLA.COM](http://www.mpegla.com)

\* Notice displayed in English as required.



### Third party software

This product includes third party software.

- expat.h

Copyright (c) 1998, 1999, 2000 Thai Open Source Software Center Ltd

Permission is hereby granted, free of charge, to any person obtaining a copy of this software and associated documentation files (the "Software"), to deal in the Software without restriction, including without limitation the rights to use, copy, modify, merge, publish, distribute, sublicense, and/or sell copies of the Software, and to permit persons to whom the Software is furnished to do so, subject to the following conditions:

The above copyright notice and this permission notice shall be included in all copies or substantial portions of the Software.

THE SOFTWARE IS PROVIDED "AS IS", WITHOUT WARRANTY OF ANY KIND, EXPRESS OR IMPLIED, INCLUDING BUT NOT LIMITED TO THE WARRANTIES OF MERCHANTABILITY, FITNESS FOR A PARTICULAR PURPOSE AND NONINFRINGEMENT. IN NO EVENT SHALL THE AUTHORS OR COPYRIGHT HOLDERS BE LIABLE FOR ANY CLAIM, DAMAGES OR OTHER LIABILITY, WHETHER IN AN ACTION OF CONTRACT, TORT OR OTHERWISE, ARISING FROM, OUT OF OR IN CONNECTION WITH THE SOFTWARE OR THE USE OR OTHER DEALINGS IN THE SOFTWARE.

## Use of Genuine Canon Accessories Is Recommended

This product is designed to achieve optimum performance when used with genuine Canon accessories. Therefore, using this product with genuine accessories is highly recommended.

Canon shall not be liable for any damage to this product and/or accidents such as malfunction, fire, etc. caused by the failure of non-genuine Canon accessories (e.g., a leakage and/or explosion of a battery pack). Please note that repairs arising out of the malfunction of non-genuine accessories will not be covered by the warranty for repairs, although you may request such repairs on a chargeable basis.

-  Battery Pack LP-E6N/LP-E6 is dedicated to Canon products only. Using it with an incompatible battery charger or product may result in malfunction or accidents for which Canon cannot be held liable.



## Digital Camera Model DS126631 Systems

This device complies with Part 15 of the FCC Rules. Operation is subject to the following two conditions: (1) This device may not cause harmful interference, and (2) this device must accept any interference received, including interference that may cause undesired operation.

**Note:** This equipment has been tested and found to comply with the limits for class B digital devices, pursuant to Part 15 of the FCC Rules. These limits are designed to provide reasonable protection against harmful interference in a residential installation. This equipment generates, uses and can radiate radio frequency energy and, if not installed and used in accordance with the instructions, may cause harmful interference to radio communications. However, there is no guarantee that interference will not occur in a particular installation. If this equipment does cause harmful interference to radio or television reception, which can be determined by turning the equipment off and on, the user is encouraged to try to correct the interference by one or more of the following measures:

- Reorient or relocate the receiving antenna.
- Increase the separation between the equipment and receiver.
- Connect the equipment into an outlet on a circuit different from that to which the receiver is connected.
- Consult the dealer or an experienced radio/TV technician for help.

The cable with the ferrite core provided with the digital camera must be used with this equipment in order to comply with Class B limits in Subpart B of Part 15 of the FCC rules.

Do not make any changes or modifications to the equipment unless otherwise specified in the manual. If such changes or modifications should be made, you could be required to stop operation of the equipment.

Canon U.S.A. Inc.  
One Canon Park, Melville, NY 11747, U.S.A.  
Tel No. 1-800-OK-CANON (1-800-652-2666)

CAN ICES-3 (B) / NMB-3 (B)



USA and Canada only:

The Lithium ion/polymer battery that powers the product is recyclable. Please call 1-800-8-BATTERY for information on how to recycle this battery.

For CA, USA only

Included lithium battery contains Perchlorate Material – special handling may apply. See [www.dtsc.ca.gov/hazardouswaste/perchlorate/](http://www.dtsc.ca.gov/hazardouswaste/perchlorate/) for details.

### **CAUTION**

RISK OF EXPLOSION IF BATTERY IS REPLACED BY AN INCORRECT TYPE.  
DISPOSE OF USED BATTERIES ACCORDING TO LOCAL REGULATION.

















# 16

## Software Start Guide / Downloading Images to a Computer

This chapter describes about the EOS software, how to download and install the software, how to use the Software Instruction Manuals (PDF files), and how to transfer images to a computer.

# Software Start Guide

## Software Overview

You can download the following EOS software from the Canon Web site (p.596).

 You cannot install the EOS software to a computer without an Internet connection.

---

### ● EOS Utility

With the camera connected to a computer, EOS Utility enables you to transfer still photos and movies shot with the camera to the computer. You can also use this software to set various camera settings and shoot remotely from the computer connected to the camera. Also, you can copy background music tracks, such as EOS Sample Music\*, to the card.

\* You can use the background music as the soundtrack for a video snapshot album, movie, or slide show played back with your camera.

### ● Digital Photo Professional

This software is recommended for users who shoot RAW images. You can view, edit, and print RAW and JPEG images.

\* Certain functions differ between the version to be installed on a 64-bit computer and that to be installed on a 32-bit computer.

### ● Picture Style Editor

You can edit Picture Styles, and create and save original Picture Style files. This software is aimed at advanced users who are experienced in image processing.

- **EOS MOVIE Utility**

This software enables you to play back the time-lapse movies you shot. You can also select time-lapse movie frames and save them as still photos (frame grab).

## Downloading and Installing the Software

- **Do not connect the camera to a computer before you install the software. The software will not be installed correctly.**
- Even if a previous version of the software is installed on your computer, follow the procedure below to install the latest version. (The previous version will be overwritten.)

### 1 Download the software.

- Connect to the Internet from a computer and access the following Canon Web site.

▶ [www.canon.com/icpd](http://www.canon.com/icpd)

- Select your country or region of residence and download the software.
- Decompress it on the computer.

**For Windows** : Click the displayed installer file to start the installer.

**For macOS** : A dmg file will be created and displayed. Follow the steps below to startup the installer.

- (1) Double-click the dmg file.
  - ▶ A drive icon and installer file will appear on the desktop. If the installer file does not appear, double-click the drive icon to display it.
- (2) Double-click the installer file.
  - ▶ The installer starts.

### 2 Follow the on-screen instructions to install the software.



## Downloading the Software Instruction Manuals

Software Instruction Manuals (PDF files) can be downloaded from the Canon Web site to your computer.

- **Software Instruction Manual Download Site**
  - ▶ [www.canon.com/icpd](http://www.canon.com/icpd)

# Downloading Images to a Computer

You can use EOS software to download images from the camera to a computer. There are two ways to do this.

## Downloading by Connecting the Camera to the Computer

### 1 Install the software (p.596).

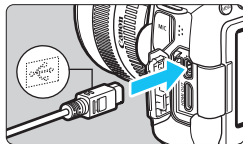

### 2 Use the interface cable (sold separately) to connect the camera to the computer.

- Connect the cable to the camera's digital terminal with the cable plug's <img alt="USB symbol icon" data-bbox="455 395 475 415"/> icon facing the front of the camera.
- Connect the cord's plug to the computer's USB terminal.

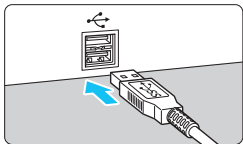

### 3 Use EOS Utility to download the images.

- Refer to the EOS Utility Instruction Manual (p.597).

 With Wi-Fi connection established, the camera cannot communicate with the computer even if they are connected with an interface cable (sold separately).

## Downloading Images with a Card Reader

You can use a card reader to download images to a computer.

**1** Install the software (p.596).

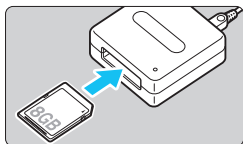

**2** Insert the card into the card reader.

**3** Use Digital Photo Professional to download the images.

- Refer to the Digital Photo Professional Instruction Manual (p.597).



When downloading images from the camera to a computer with a card reader without using EOS software, copy the DCIM folder on the card to the computer.

# Index

## Numerics

10- or 2-sec. self-timer .....	159
1280x720 (movie) .....	341
1920x1080 (movie) .....	341
3840x2160 (Time-lapse movie) .....	350
4, 9, 36, or 100 images .....	399

## A

(Scene Intelligent Auto) .....	94
AC adapter .....	520
Acceleration/deceleration tracking .....	476
Access lamp .....	44, 45
Accessories .....	3
Adjust all by same amount (AF) .....	491
Adobe RGB .....	208
AE lock .....	249
AEB (Auto Exposure Bracketing) .....	247, 472
AF .....	129
AF area selection mode .....	134, 136, 139
AF assist beam .....	480
AF groups .....	145
AF method .....	308, 374
AF Microadjustment .....	491
AF operation .....	130, 305
AF point automatic selection .....	135, 140
AF point red illumination ...	133, 488
AF point selection .....	137, 500
AF sensor .....	143
AF speed .....	376

Area AF frame .....	135, 140
Beeper .....	73
Color tracking .....	142, 485
Cross-type focusing .....	143
Difficult subjects for AF ....	153, 316
Direct AF point selection .....	500
Dual cross-type focusing .....	143
F8 AF .....	143, 144
Manual focusing .....	154, 321
Number of AF points .....	145
Out of focus .....	55, 56, 551
Recomposing .....	97, 131, 249
Spot AF point .....	31, 139
AF point auto switching .....	477
AF-ON (AF start) button .....	56, 498
AI FOCUS (AI Focus AF) .....	132
AI SERVO (AI Servo AF) .....	97, 132
Acceleration/deceleration tracking .....	476
AF point auto switching .....	477
AF points light up in red .....	133
Initial position .....	484
Tracking sensitivity .....	475
Album (Video snapshot) .....	361
ALL-I (For editing/I-only) .....	350
Ambience priority (AWB) .....	187
Ambience-based shots () .....	101
Anti-flicker shooting .....	206
Aperture-priority AE .....	238
Area AF frame .....	135, 140
Aspect ratio .....	168
Attenuator .....	347
Auto () .....	177
Auto Lighting Optimizer .....	194
Auto playback .....	424

Auto power off ..... 47, 73  
 Auto reset ..... 213  
 Auto time setting (GPS) ..... 227  
 Autofocus → AF  
 Automatic selection (AF) ..... 135, 140  
 Av (Aperture-priority AE) ..... 238

## B

B (Bulb) ..... 250, 326  
 B/W ..... 178, 182  
 Background blur (CA) ..... 103  
 Background music ..... 426  
 Basic information display ..... 391  
 Basic Zone modes ..... 35  
 Battery → Power  
 Battery Grip ..... 514, 516  
 Beep (Beeper) ..... 73  
 Bit rate ..... 574  
 Black-and-white  
 images ..... 101, 178, 182  
 Bluetooth function ..... 273  
 Bracketing  
   AEB (Auto Exposure  
   Bracketing) ..... 247, 472  
   FEB (Flash Exposure  
   Bracketing) ..... 285  
   White balance bracketing ..... 192, 472  
 Brightness (SCN) ..... 106, 127, 128  
 Built-in microphones ..... 326  
 Bulb exposures ..... 250  
   Bulb timer ..... 251  
 buSY (BUSY) ..... 167, 198

## C

C1/C2 (Custom shooting) ..... 510  
 CA (Creative Auto) ..... 100  
 Camera  
   Camera shake ..... 55, 96  
   Camera vibration blur ..... 96, 265  
   Default settings ..... 75  
   Holding the camera ..... 55  
 Candlelight ..... 118  
 Cards ..... 5, 27, 43, 70, 343  
   Card reminder ..... 44  
   Card requirements ..... 343  
   Formatting ..... 70  
   Low-level formatting ..... 71  
   Troubleshooting ..... 45, 71  
   Write-protect switch ..... 43  
 Center-weighted average  
 metering ..... 244  
 Certification Logo ..... 513  
 Charger ..... 37, 40  
 Chromatic aberration  
 correction ..... 201, 442  
 Cleaning (image sensor) ..... 449  
 Clipped highlights ..... 397  
 CLn ..... 455  
 Close-ups ..... 116  
 Color space ..... 208  
 Color temperature ..... 185, 190  
 Color tone ..... 181  
 Color tone (SCN) ..... 106, 128  
 Color tracking ..... 142, 485  
 Continuous (file numbering) ..... 212  
 Continuous shooting ..... 156

Contrast ..... 181, 194  
 Copyright information ..... 214  
 Creative Auto ..... 100  
 Creative Zone modes ..... 36  
 Cropping (images) ..... 446  
 Cross-type focusing ..... 143  
 Custom Controls ..... 497  
 Custom Functions ..... 468, 469, 471  
 Custom shooting mode ..... 510

**D**



D+ ..... 199  
 Date/time ..... 49  
 Daylight saving time ..... 51  
 DC Coupler ..... 520  
 Default settings ..... 75  
   Camera settings ..... 75  
   Custom Controls ..... 497  
   Custom Functions ..... 468  
   Custom shooting mode ..... 510  
   Flash function settings ..... 287  
   My Menu ..... 508  
 Default settings tables ..... 75  
 Depth-of-field preview ..... 240  
 Dials  
   Main Dial ..... 57  
   Quick Control Dial ..... 58  
 Diffraction correction ..... 203, 443  
 Digital terminal ..... 29, 598  
 Dioptic adjustment ..... 55  
 Direct selection (AF point) ..... 500  
 Distortion correction ..... 202, 442  
 Double-tap ..... 407



Downloading images to a  
 computer ..... 598  
 DPOF  
 (Digital Print Order Format) ..... 458  
 Dragging ..... 68  
 Drive mode ..... 156  
 Dual cross-type focusing ..... 143  
 Dust Delete Data ..... 452

**E**

Electronic level ..... 80, 81  
 Erasing images ..... 430  
 Err (error codes) ..... 567  
 Evaluative metering ..... 243  
 exFAT ..... 71, 345  
 Expanded ISO speed ... 170, 173, 372  
 Exposure compensation ..... 245  
 Exposure compensation in M mode  
 with ISO Auto ..... 242  
 Exposure level increments ..... 471  
 Exposure level  
 indicator ..... 32, 34, 293, 334  
 Exposure simulation ..... 303  
 External Speedlite → Flash  
 External microphone ..... 347  
 Eyecup ..... 270  
 Eye-Fi cards ..... 522  
 Eyepiece cover ..... 38, 270

**F**

 1920x1080  
 (Time-lapse movie) ..... 350  
 +Tracking ..... 309

- Faithful (  ) ..... 178
  - FAT32 ..... 71, 345
  - FE lock ..... 278
  - Feature guide ..... 90
  - FEB  
(Flash Exposure Bracketing) ..... 285
  - File extension ..... 211
  - File name
    - Underscore “\_” ..... 208
  - File size ..... 164, 344, 345
  - Filter effect (Monochrome) ..... 182
  - Final image simulation ..... 297, 338
  - Fine (Image-recording quality) ..... 162
  - Fine Detail (  ) ..... 177
  - Fineness (Sharpness) ..... 181
  - Firmware ..... 543
  - First-curtain synchronization ..... 285
  - Flash (Speedlite) ..... 277
    - Custom Functions ..... 286
    - External flash units ..... 278
    - FE lock ..... 278
    - FEB (Flash Exposure Bracketing) ..... 285
    - Flash control  
(function settings) ..... 281
    - Flash exposure compensation ..... 278, 285
    - Flash sync speed ..... 280, 282
    - Manual flash ..... 283
    - Shutter synchronization  
(1st/2nd curtain) ..... 285
    - Wireless ..... 284
  - Flash exposure compensation ..... 278, 285
  - Flash mode ..... 283
  - Flash sync contacts ..... 28
  - Flash sync. speed in Av mode ..... 282
  - Focus indicator ..... 94, 131
  - Focus lock ..... 97, 131
  - Focus mode switch ..... 6, 53, 154, 321
  - Focusing → AF
  - Focusing point  
(AF point) ..... 134, 137, 139, 143
  - Folder creation/selection ..... 209, 210
  - Food ..... 117
  - For editing (ALL-I) ..... 350
  - Formatting (card initialization) ..... 70
  - Frame rate ..... 342
  - Full Auto mode ..... 94
  - Full High-Definition (Full HD)  
(movie) ..... 325, 341, 350
  - Functions available by shooting  
mode ..... 526
- ## G
- GPS ..... 217
  - Grid display ..... 79, 302, 377, 390
  - Group Photo ..... 110
- ## H
- H1/H2 (Expanded ISO  
speed) ..... 170, 173, 372
  - Handheld Night Scene ..... 120
  - HDMI ..... 417, 427
  - HDMI CEC ..... 428
  - HDR Backlight Control ..... 121
  - HDR movie shooting ..... 348

HDR shooting .....	253
Help .....	91
Text size .....	92
High dynamic range → HDR	
High ISO speed noise reduction ...	195
High-Definition .....	341
Highlight alert .....	397
Highlight tone priority .....	199
High-speed continuous shooting ..	156
Histogram .....	293, 398
Hot shoe .....	28, 278
Household power .....	520

## I

ICC profile .....	208
Icons .....	8
Illumination (AF point) .....	488
Illumination (LCD panel) .....	60
Image browsing (Jump display) ....	400
Image dust prevention .....	449
Image review time .....	74
Image search .....	402
Image-recording	
quality .....	162, 164, 341
Images	
AF point display .....	397
Auto playback .....	424
Auto reset .....	213
Auto rotation .....	435
Continuous (file numbering) ....	212
Downloading (to computer) .....	598
Erasing .....	430
File numbering .....	211
Highlight alert .....	397
Histogram .....	398
Image-recording	
quality .....	162, 164, 341
Index display .....	399
Jump display (image browsing) ..	400
Magnifying images .....	404
Manual reset .....	213
Manual rotation .....	408
Playback .....	387
Protecting .....	409
Rating .....	412
Search conditions .....	402
Shooting information .....	392
Slide show .....	424
Viewing on a TV set .....	417, 427
Index display .....	399
INFO	
button .....	60, 84, 293, 298, 334, 388
Initial AF Point .....	484
Initial magnification ratio/position .	405
Interval timer .....	267
IPB .....	342
ISO speed .....	170, 327, 331
Auto range (Still photos) .....	174
Automatic setting (ISO Auto) ...	172
ISO Auto (movie) .....	372
ISO expansion .....	173
ISO speed range .....	173, 372
Manual setting range .....	173
Minimum shutter speed for ISO	
Auto (Still photos) .....	175
Setting increments .....	471
Time-lapse ISO Auto .....	372

## J

JPEG .....	162, 164
------------	----------



Jump display .....400

## K

Kids ..... 113

## L

Landscape ..... 111

Landscape (L) ..... 177

Language ..... 52

Large (image-recording quality) ... 164

Large Zone AF ..... 135, 140

LCD monitor ..... 27, 46

Adjusting angle ..... 46, 99

Brightness ..... 434

Electronic level ..... 80, 84

Image Playback ..... 387

Menu display ..... 64, 534

Quick Control ..... 61, 86

LCD Panel

Illumination ..... 60

Lens ..... 27, 53

AF group designations ..... 145

Chromatic aberration

correction ..... 201

Diffraction correction ..... 203

Distortion correction ..... 202

Focus mode

switch ..... 6, 53, 154, 321

Lock release ..... 54

Optical aberration correction ... 200

Peripheral illumination

correction ..... 200

Lens electronic MF ..... 155

Light (IPB) ..... 342

Live View shooting ..... 98, 289

AF operation ..... 305

Exposure simulation ..... 303

+Tracking ..... 309

Grid display ..... 302

Information display ..... 293

Live 1-point AF ..... 313

Manual focusing ..... 321

Metering timer ..... 302

Possible shots ..... 291

Quick Control ..... 301

Silent LV shooting ..... 303

Smooth zone ..... 311

LOCK ..... 59, 88

LOG ..... 228

Logging ..... 228

Log Data ..... 229

Long (bulb) exposures ..... 250

Long Exposure Noise Reduction .. 197

Low-speed continuous shooting ... 157

LV → Live View shooting

## M

M (Manual exposure) ..... 241, 330

Magnifying images ..... 317, 321, 404

Main Dial ..... 57

Malfunction ..... 548

Manual exposure ..... 241, 330

Manual focus ..... 154, 321





Manual focusing ..... 154, 321

Manual reset ..... 213

Manual selection

(AF point) ..... 134, 137, 139

Maximum burst ..... 164, 167

- Medium
  - (image-recording quality) ..... 164
- Memory cards → Cards
- Menu ..... 64
  - Dimmed menu items ..... 66
  - My Menu ..... 505
  - Setting procedure ..... 65
  - Settings ..... 534
- MENU** icon ..... 8
- Metering mode ..... 243
- Metering timer ..... 56, 302, 377
- MF (Manual focusing) ..... 154, 321
- Microadjustment ..... 491
- Microphone
  - Built-in ..... 326
  - External ..... 347
- Mirror lockup ..... 265
- Mode Dial ..... 35, 57
- Monochrome () ..... 178
- Motion JPEG () ..... 350
- MOV () ..... 350
- Movies ..... 325
  - AE lock ..... 328
  - AF method ..... 308, 374
  - AF speed during
    - Movie Servo AF ..... 376
  - Attenuator ..... 347
  - Autoexposure shooting ..... 326
  - Cards suited for movie
    - shooting ..... 343
  - Compression method ..... 342, 350
  - Editing ..... 422
  - Editing out first and
    - last scenes ..... 422
  - Enjoying movies ..... 417
  - External microphone ..... 347
  - File size ..... 344, 345
  - Frame rate ..... 342
  - Grid display ..... 377
  - HDR movie shooting ..... 348
  - Information display ..... 334
  - Manual exposure shooting ..... 330
  - Metering timer ..... 377
  - Microphone ..... 326, 347
  - Movie digital IS ..... 380
  - Movie recording method ..... 350
  - Movie recording size ..... 341
  - Movie Servo AF ..... 373, 375, 376
  - Movie Servo AF tracking
    - sensitivity ..... 375
  - Movie shooting button ..... 326, 378
  - Playback ..... 417, 419
  - Quick Control ..... 339
  - Recording time ..... 344
  - Servo AF ..... 373
  - Shutter speed ..... 330, 333
  - Sound recording/
    - Sound-recording level ..... 346
    - Time-lapse movie ..... 349
  - Video snapshots ..... 361
  - Viewing on a TV set ..... 417, 427
  - Wind filter ..... 346
- MP4 () ..... 342
- M-RAW
  - (Medium RAW) ..... 162, 164, 165, 166
- Multi function lock ..... 59, 88
- Multi Shot Noise Reduction ..... 195
- Multi-controller ..... 59
- Multiple exposure ..... 258
- MWB ..... 188
- My Menu ..... 505

**N**

Neutral (  ) .....	177
NFC connection .....	29, 540
Night Portrait .....	119
Noise reduction	
High ISO speed .....	195
Long exposures .....	197
Nomenclature .....	28
Non-Canon flash units .....	280
Normal (Image-recording quality) .	162
NTSC .....	342, 427, 541

**O**

ONE SHOT (One-Shot AF) ...	131, 306
One-Shot AF .....	131, 306

**P**

P (Program AE) .....	234, 326
PAL .....	342, 427, 541
Panning .....	114
Panning effect .....	115
Partial metering .....	243
Peripheral illumination	
correction .....	200, 442
Photobook set-up .....	464
Picture Style .....	176, 180, 183
Pixel count .....	162, 164
Play (Frame skip) .....	421
Playback .....	387
Portrait .....	109
Portrait (  ) .....	177
Positioning hole .....	30
Positioning interval (GPS) .....	226

## Possible recording time

(movie) .....

Possible shots .....

Power .....

    Auto power off .....

    Battery information .....

    Battery level .....

    Charging .....

    Household power .....

    Possible shots .....

    Recharge performance .....

Pressing completely .....

Pressing halfway .....

## Printing

    Print order (DPOF) .....

    Photobook set-up .....

Program AE .....

    Program shift .....

Protecting images .....

**Q** (Quick

Control) .....

Quick Control Dial .....

**R**

Rating .....

Rating mark .....

RAW .....

RAW image processing .....

RAW+JPEG .....

Recharging .....

Reduced display .....

Release shutter without card .....

Remote control terminal..... 28, 276  
 Remote controller ..... 271, 273  
 Remote switch ..... 276  
 Repeat (slide show)..... 424  
 Resizing ..... 444  
 Rotation (image)..... 408

## S

Safety precautions ..... 22  
 Safety shift ..... 473  
 Saturation ..... 181  
 Scene icons ..... 295, 329  
 Scene Intelligent Auto ..... 94  
 SCN ..... 35, 107, 348  
 SD, SDHC, SDXC cards → Cards  
 Second-curtain synchronization... 285  
 Self-timer ..... 159  
 Sensitivity → ISO speed  
 Sensor cleaning ..... 449  
 Sepia (Monochrome) ..... 101, 182  
 Serial number ..... 30, 494, 516  
 SERVO AF ..... 307  
 Servo AF  
   AI SERVO AF ..... 97, 132  
   Movie Servo AF ..... 373, 375, 376  
   SERVO (LV) ..... 307  
 Sharpness..... 181  
 Shooting information display..... 392  
 Shooting mode guide ..... 89  
 Shooting modes..... 35  
   M (Manual exposure) ..... 241, 330  
   Av (Aperture-priority AE) ..... 238  
   B (Bulb) ..... 250  
   **C1/C2** (Custom shooting)..... 510  
   **CA** (Creative Auto)..... 100  
   **CA+** (Scene Intelligent Auto)..... 94  
   P (Program AE)..... 234  
   **SCN** (Special scene) ..... 107  
   Tv (Shutter-priority AE) ..... 236  
 Shutter button..... 56  
 Shutter button functions ..... 378  
 Shutter synchronization..... 285  
 Shutter-priority AE ..... 236  
 Silent shooting  
   Silent continuous shooting..... 157  
   Silent LV shooting ..... 303  
   Silent single shooting ..... 157  
 Single shooting..... 156, 157  
 Single-image display ..... 388  
 Single-point AF ..... 134, 139, 313  
 Single-point Spot AF ..... 134, 139  
 Slide show ..... 424  
 Small (image-recording quality) ... 164  
 Smooth zone ..... 311  
 Software ..... 594  
   Instruction Manual ..... 597  
 Sound recording/Sound-recording  
   level..... 346  
 Speaker ..... 29, 419  
 Special scene mode (SCN).. 107, 348  
 Specifications ..... 568  
 Sports..... 112  
 Spot AF point..... 31, 139  
 Spot metering..... 244  
 S-RAW  
   (Small RAW)..... 162, 164, 165, 166  
 sRGB..... 208

Standard (IPB) .....	342
Standard (  ) .....	177
★ icon .....	8
Strap .....	38
Strength (Sharpness) .....	181
Subjects difficult to focus .....	153, 316, 374
System map .....	514

## T

Temperature warning .....	323, 382
Threshold (Sharpness) .....	181
Tilt correction .....	80, 447
Time zone .....	49
Time-lapse movie .....	349
Tone priority .....	199
Toning effect (Monochrome) .....	182
Touch beeping .....	73
Touch operation .....	67, 406
Touch Shutter .....	319
Tracking sensitivity .....	475
Transition effect (slide show) .....	425
Tripod socket .....	30
Troubleshooting .....	548
Tv (Shutter-priority AE) .....	236

## U

UHS-I .....	5, 343
Underscore “_” .....	208
USB (digital) terminal .....	29, 598
User Def. (  ) .....	178
UTC (Coordinated Universal Time) .....	218

## V

Vari-angle LCD monitor .....	46, 99
Vertical image auto rotation .....	435
Video snapshots .....	361
Video system .....	341, 427, 541
Viewfinder	
Dioptic adjustment .....	55
Electronic level .....	81
Grid display .....	79
Information display .....	82
Viewing on a TV set .....	417, 427
Volume (movie playback) .....	420

## W

Warning icon .....	489
White balance (WB) .....	185
Auto .....	187
Bracketing .....	192
Color temperature setting .....	190
Correction .....	191
Custom .....	188
White priority (AWB) .....	187
Wi-Fi function .....	540
Wind filter .....	346
Wireless communication settings .....	540

## Z

Zone AF .....	134, 139
---------------	----------

**Canon**